

# Bohrstar 54



**BORING KITS** from  $\varnothing 6$  mm up to 210 mm



# Coupling system

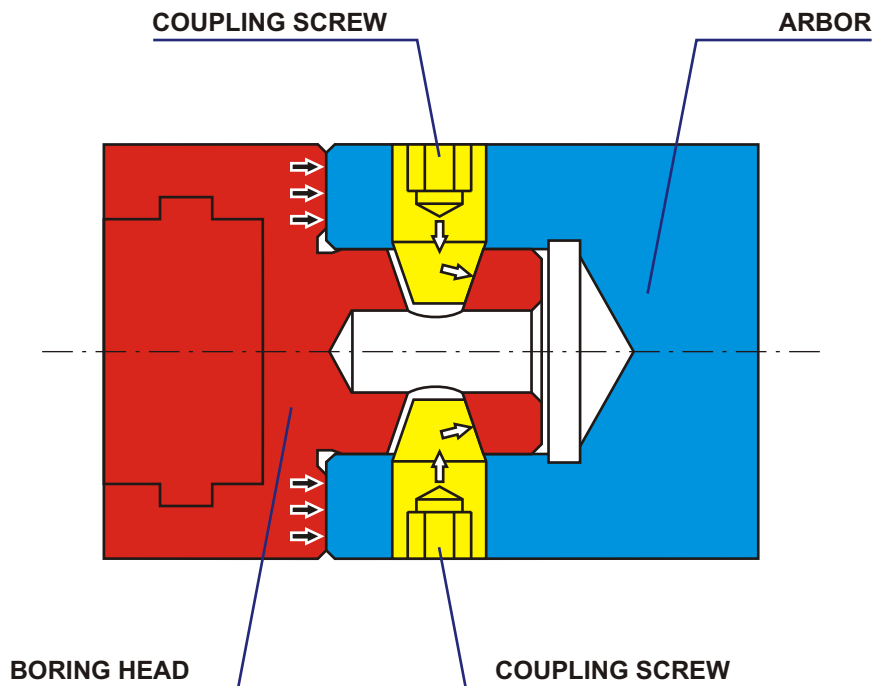

## HIGH RIGIDITY

By tightening the two cone shaped coupling screws, high axial forces are developed in the tapered holes of the pilot shank. These axial forces preload the contact surface between the flange faces of the coupled components with high axial pressure for ample support against lateral loads. It can also dampen vibrations.

## POSITIVE TOOL ORIENTATION

The locating pin guarantees repeat positioning between components at all times.

**All arbors, extensions and reducers are shipped complete with coupling screws.**

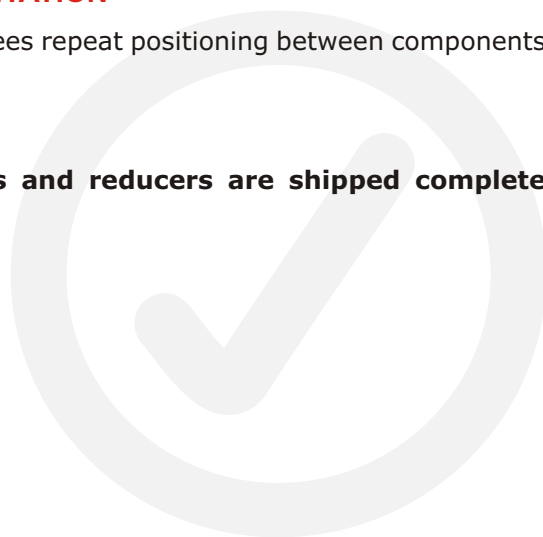

MAS BT 403  
page 16

DIN 69871  
page 17

DIN 2080  
page 18

DIN 69893  
HSK - A  
page 19

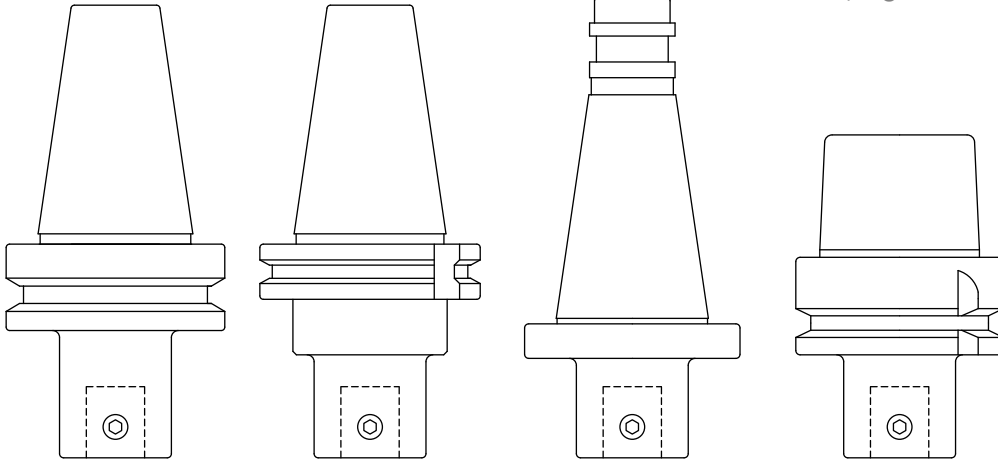

ACCESSORIES  
page 20

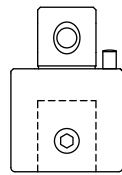

BORING HEAD  
page 20

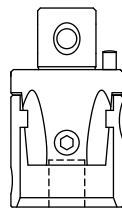

BORING BARS  
page 21

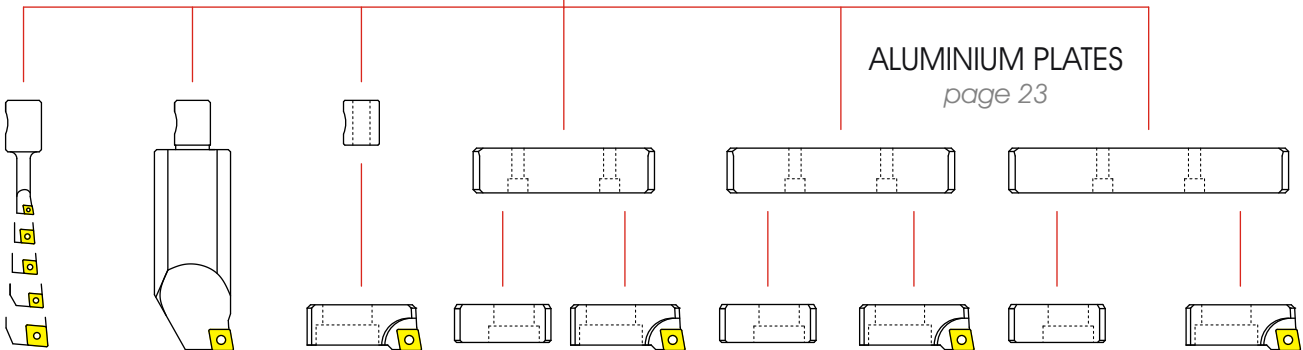

CARTRIDGES  
page 22

# Bohrstar 54 KIT

Rhombic insert 

Ø 6 - 43

[www.pinzbohr.com](http://www.pinzbohr.com)



**ORDERING NUMBER:**  
**BS 54 KIT R 6-043**

	Description	Product Number	Qty.
1	Bohrstar head	BS 054 16	1
	Boring bar 5 mm.	BS 05 16 R01	1
	Boring bar 6 mm.	BS 06 16 R01	1
2	Boring bar 8 mm.	BS 08 16 R03	1
	Boring bar 10 mm.	BS 10 16 R03	1
	Boring bar 12 mm.	BS 12 16 R03	1
	Boring bar 16 mm.	BS 16 16 R04	1

	Description	Product Number	Qty.
3	Hexagonal key 3	HK 030	1
	Hexagonal key 5	HK 050	1
	Hexagonal key 6	HK 060	1
4	Torx key 6	TK 06	1
	Torx key 8	TK 08	1
	Torx key 15	TK 15	1

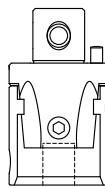

From Ø 6  
To Ø 43

# Bohrstar 54 KIT

Rhombic insert 

Ø 8 - 43

[www.pinzbohr.com](http://www.pinzbohr.com)

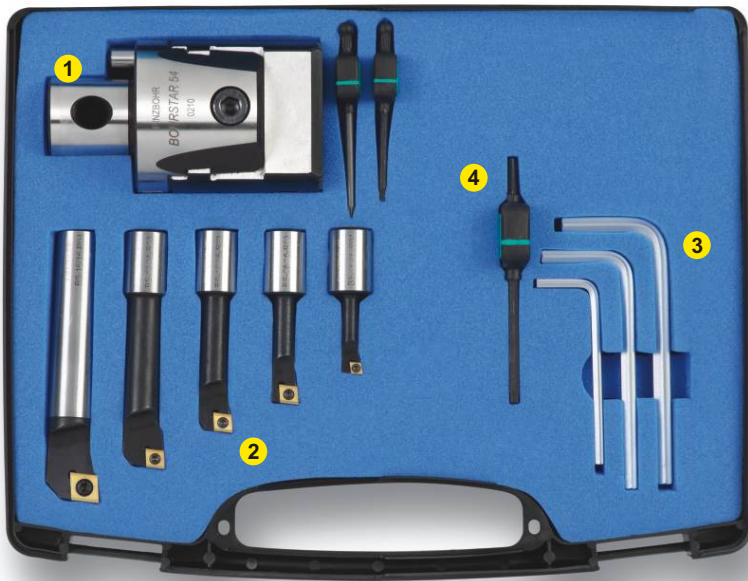

**ORDERING NUMBER:**  
**BS 54 KIT R 8-043**

	Description	Product Number	Qty.
1	Bohrstar head	BS 054 16	1
	Boring bar 6 mm.	BS 06 16 R01	1
	Boring bar 8 mm.	BS 08 16 R03	1
2	Boring bar 10 mm.	BS 10 16 R03	1
	Boring bar 12 mm.	BS 12 16 R03	1
	Boring bar 16 mm.	BS 16 16 R04	1

	Description	Product Number	Qty.
3	Hexagonal key 3	HK 030	1
	Hexagonal key 5	HK 050	1
	Hexagonal key 6	HK 060	1
4	Torx key 6	TK 06	1
	Torx key 8	TK 08	1
	Torx key 15	TK 15	1

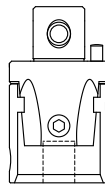

From Ø 8  
To Ø 43

# Bohrstar 54 KIT

Rhombic insert 

Ø 6 - 100

[www.pinzbohr.com](http://www.pinzbohr.com)



**ORDERING NUMBER:**  
**BS 54 KIT R 6-100**

	Description	Product Number	Qty.
1	Bohrstar head	BS 054 16	1
	Boring bar 5 mm.	BS 05 16 R01	1
	Boring bar 6 mm.	BS 06 16 R01	1
	Boring bar 8 mm.	BS 08 16 R03	1
2	Boring bar 10 mm.	BS 10 16 R03	1
	Boring bar 12 mm.	BS 12 16 R03	1
	Boring bar 16 mm.	BS 16 16 R04	1
	Boring bar 34 mm.	BS 34 16 R04	1
3	Boring bar 34 mm.	BS 34 16 R04	1
4	Cartridge	BS 2CT R04	1

	Description	Product Number	Qty.
5	Location sleeve	BS 16 M10	1
6	Hexagonal key 3	HK 030	1
	Hexagonal key 5	HK 050	1
	Hexagonal key 6	HK 060	1
	Hexagonal key 8	HK 080	1
7	Torx key 6	TK 06	1
	Torx key 8	TK 08	1
	Torx key 15	TK 15	1
8	Cartridge screw	CS 10 25	1

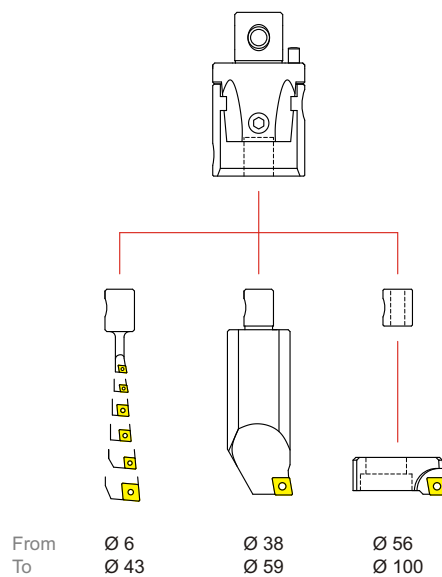



# Bohrstar 54 KIT

Rhombic insert 

Ø 8 - 100

[www.pinzbohr.com](http://www.pinzbohr.com)



**ORDERING NUMBER:**  
**BS 54 KIT R 8-100**

	Description	Product Number	Qty.
1	Bohrstar head	BS 054 16	1
	Boring bar 6 mm.	BS 06 16 R01	1
	Boring bar 8 mm.	BS 08 16 R03	1
2	Boring bar 10 mm.	BS 10 16 R03	1
	Boring bar 12 mm.	BS 12 16 R03	1
	Boring bar 16 mm.	BS 16 16 R04	1
3	Boring bar 34 mm.	BS 34 16 R04	1
4	Cartridge	BS 2CT R04	1
5	Location sleeve	BS 16 M10	1

	Description	Product Number	Qty.
	Hexagonal key 3	HK 030	1
6	Hexagonal key 5	HK 050	1
	Hexagonal key 6	HK 060	1
	Hexagonal key 8	HK 080	1
	Torx key 6	TK 06	1
7	Torx key 8	TK 08	1
	Torx key 15	TK 15	1
8	Cartridge screw	CS 10 25	1

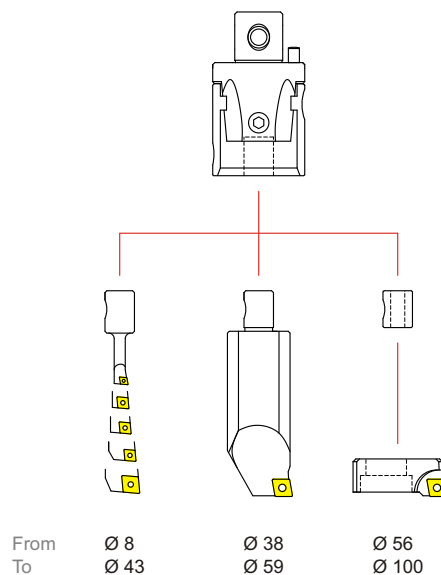

# Bohrstar 54 KIT

Rhombic insert 

Ø 6 - 170

[www.pinzbohr.com](http://www.pinzbohr.com)

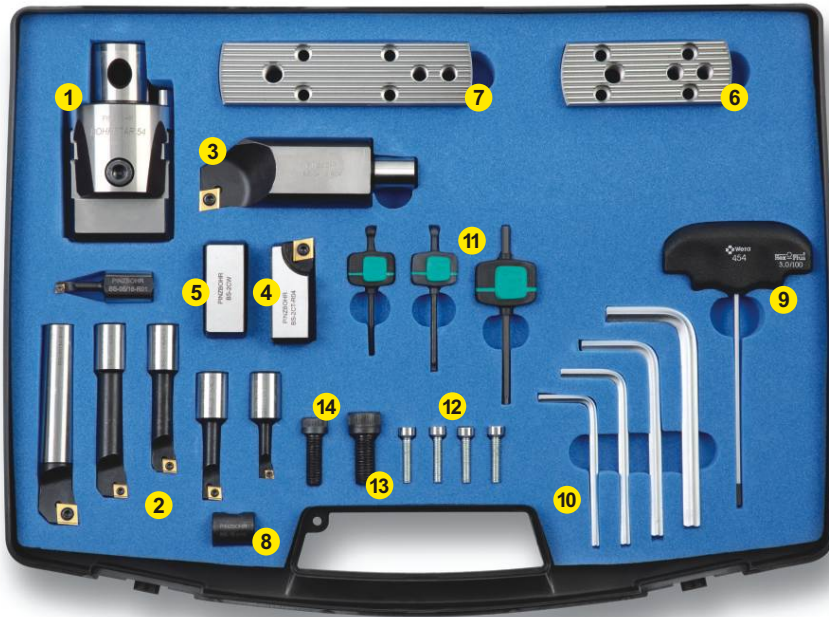

**ORDERING NUMBER:**  
**BS 54 KIT R 6-170**

Description	Product Number	Qty.	Description	Product Number	Qty.
1 Bohrstar head	BS 054 16	1	8 Location sleeve	BS 16 M10	1
2 Boring bar 5 mm.	BS 05 16 R01	1	9 Adjusting key	AK 03	1
3 Boring bar 6 mm.	BS 06 16 R01	1	10 Hexagonal key 4	HK 040	1
4 Boring bar 8 mm.	BS 08 16 R03	1	11 Hexagonal key 5	HK 050	1
5 Boring bar 10 mm.	BS 10 16 R03	1	12 Hexagonal key 6	HK 060	1
6 Boring bar 12 mm.	BS 12 16 R03	1	13 Hexagonal key 8	HK 080	1
7 Boring bar 16 mm.	BS 16 16 R04	1	14 Torx key 6	TK 06	1
8 Boring bar 34 mm.	BS 34 16 R04	1	15 Torx key 8	TK 08	1
9 Cartridge	BS 2CT R04	1	16 Torx key 15	TK 15	1
10 Counterweight	BS 2CW	1	17 Plate fixing screws	D 027 21	4
11 Small plate	BS SP 085 130	1	18 Cartridge screw	CS 10 25	1
12 Medium plate	BS SP 125 170	1	19 Counterweight screw	CS 08 25	1

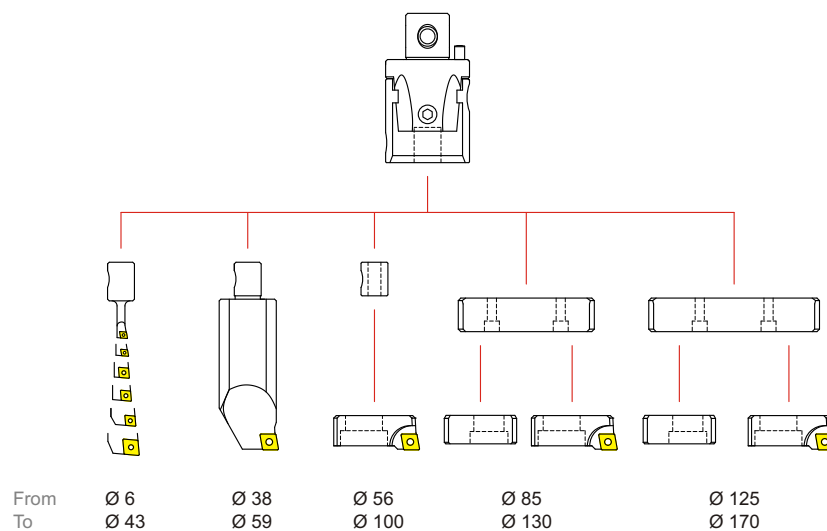



# Bohrstar 54 KIT

Rhombic insert 

Ø 8 - 170

[www.pinzbohr.com](http://www.pinzbohr.com)

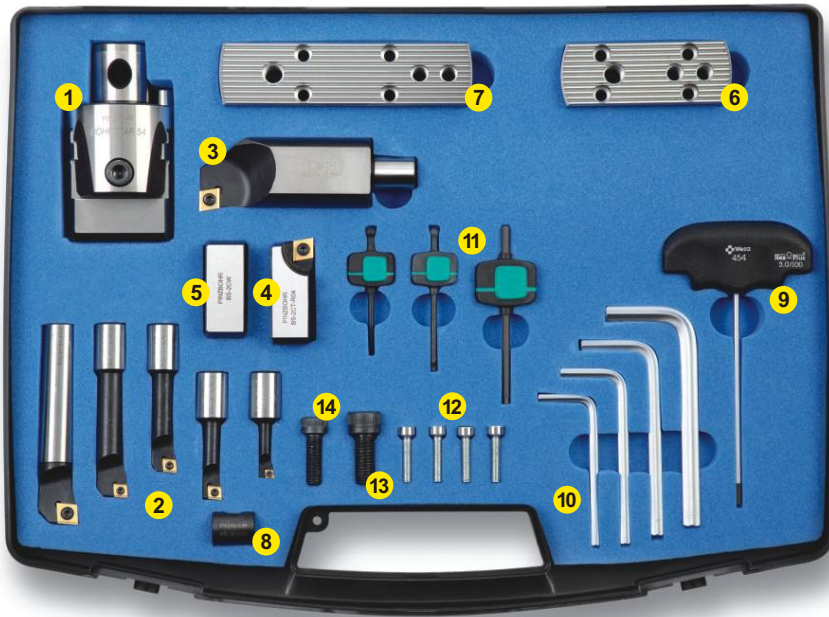

**ORDERING NUMBER:**  
**BS 54 KIT R 8-170**

	Description	Product Number	Qty.
1	Bohrstar head	BS 054 16	1
	Boring bar 6 mm.	BS 06 16 R01	1
	Boring bar 8 mm.	BS 08 16 R03	1
2	Boring bar 10 mm.	BS 10 16 R03	1
	Boring bar 12 mm.	BS 12 16 R03	1
	Boring bar 16 mm.	BS 16 16 R04	1
3	Boring bar 34 mm.	BS 34 16 R04	1
4	Cartridge	BS 2CT R04	1
5	Counterweight	BS 2CW	1
6	Small plate	BS SP 085 130	1
7	Medium plate	BS SP 125 170	1
8	Location sleeve	BS 16 M10	1

	Description	Product Number	Qty.
9	Adjusting key	AK 03	1
	Hexagonal key 4	HK 040	1
	Hexagonal key 5	HK 050	1
10	Hexagonal key 6	HK 060	1
	Hexagonal key 8	HK 080	1
	Torx key 6	TK 06	1
11	Torx key 8	TK 08	1
	Torx key 15	TK 15	1
12	Plate fixing screws	D 027 21	4
13	Cartridge screw	CS 10 25	1
14	Counterweight screw	CS 08 25	1

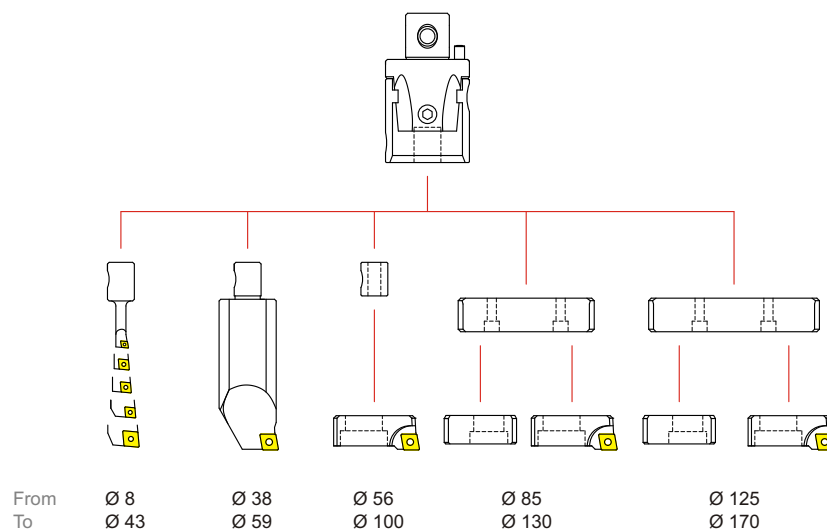

# Bohrstar 54 KIT

Rhombic insert 

Ø 6 - 210

[www.pinzbohr.com](http://www.pinzbohr.com)

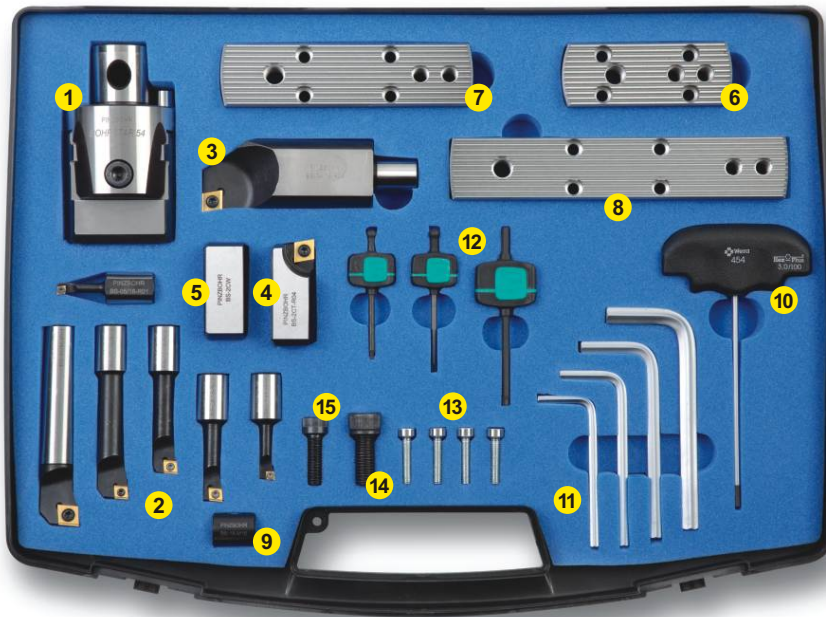

**ORDERING NUMBER:**  
**BS 54 KIT R 6-210**

	Description	Product Number	Qty.
1	Bohrstar head	BS 054 16	1
2	Boring bar 5 mm.	BS 05 16 R01	1
	Boring bar 6 mm.	BS 06 16 R01	1
	Boring bar 8 mm.	BS 08 16 R03	1
	Boring bar 10 mm.	BS 10 16 R03	1
	Boring bar 12 mm.	BS 12 16 R03	1
	Boring bar 16 mm.	BS 16 16 R04	1
	Boring bar 34 mm.	BS 34 16 R04	1
3	Cartridge	BS 2CT R04	1
4	Counterweight	BS 2CW	1
5	Small plate	BS SP 085 130	1
6	Medium plate	BS SP 125 170	1
7	Large plate	BS SP 165 210	1

	Description	Product Number	Qty.
9	Location sleeve	BS 16 M10	1
10	Adjusting key	AK 03	1
11	Hexagonal key 4	HK 040	1
	Hexagonal key 5	HK 050	1
	Hexagonal key 6	HK 060	1
	Hexagonal key 8	HK 080	1
	Torx key 6	TK 06	1
	Torx key 8	TK 08	1
	Torx key 15	TK 15	1
12	Plate fixing screws	D 027 21	4
13	Cartridge screw	CS 10 25	1
14	Counterweight screw	CS 08 25	1

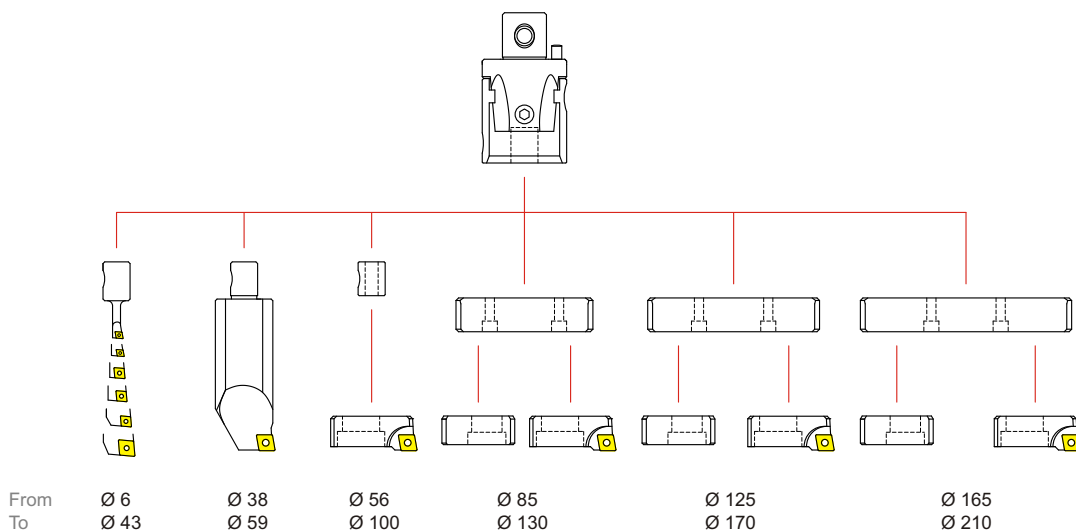

# Bohrstar 54 KIT

Rhombic insert 

Ø 8 - 210

[www.pinzbohr.com](http://www.pinzbohr.com)

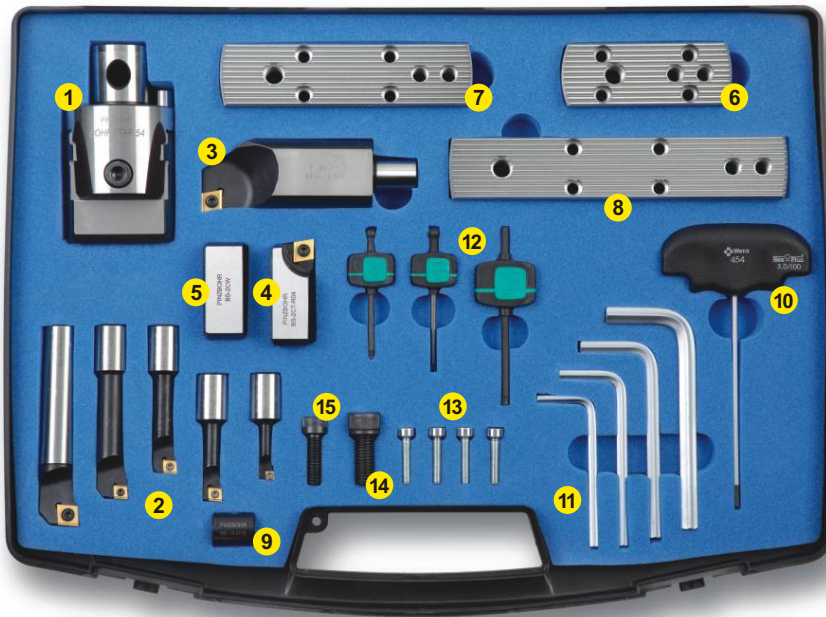

**ORDERING NUMBER:**  
**BS 54 KIT R 8-210**

	Description	Product Number	Qty.
1	Bohrstar head	BS 054 16	1
	Boring bar 6 mm.	BS 06 16 R01	1
	Boring bar 8 mm.	BS 08 16 R03	1
2	Boring bar 10 mm.	BS 10 16 R03	1
	Boring bar 12 mm.	BS 12 16 R03	1
	Boring bar 16 mm.	BS 16 16 R04	1
3	Boring bar 34 mm.	BS 34 16 R04	1
4	Cartridge	BS 2CT R04	1
5	Counterweight	BS 2CW	1
6	Small plate	BS SP 085 130	1
7	Medium plate	BS SP 125 170	1
8	Large plate	BS SP 165 210	1

	Description	Product Number	Qty.
9	Location sleeve	BS 16 M10	1
10	Adjusting key	AK 03	1
	Hexagonal key 4	HK 040	1
	Hexagonal key 5	HK 050	1
11	Hexagonal key 6	HK 060	1
	Hexagonal key 8	HK 080	1
	Torx key 6	TK 06	1
12	Torx key 8	TK 08	1
	Torx key 15	TK 15	1
13	Plate fixing screws	D 027 21	4
14	Cartridge screw	CS 10 25	1
15	Counterweight screw	CS 08 25	1

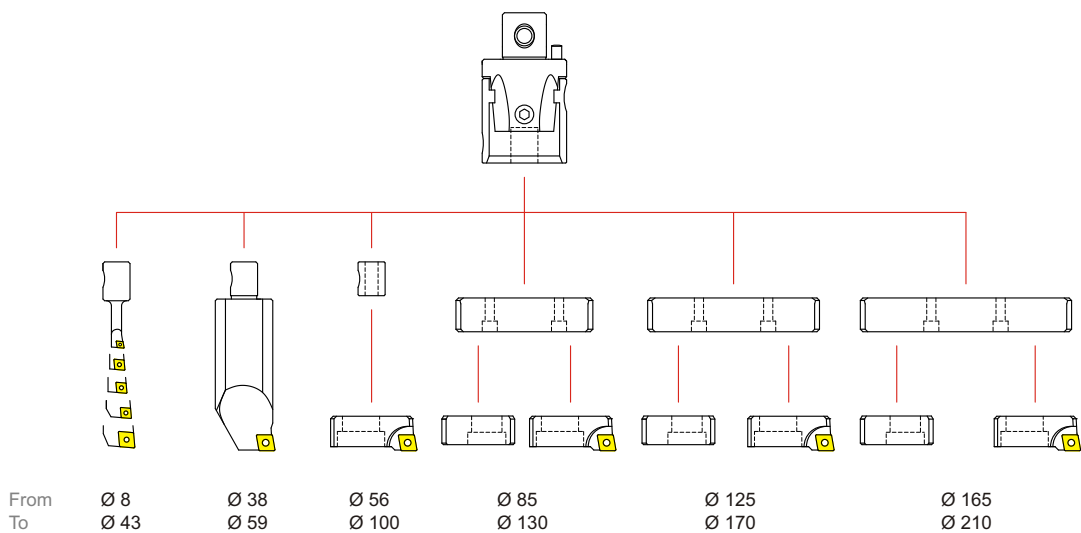

# Bohrstar 54 KIT

Triangular insert 

Ø 8 - 43

[www.pinzbohr.com](http://www.pinzbohr.com)

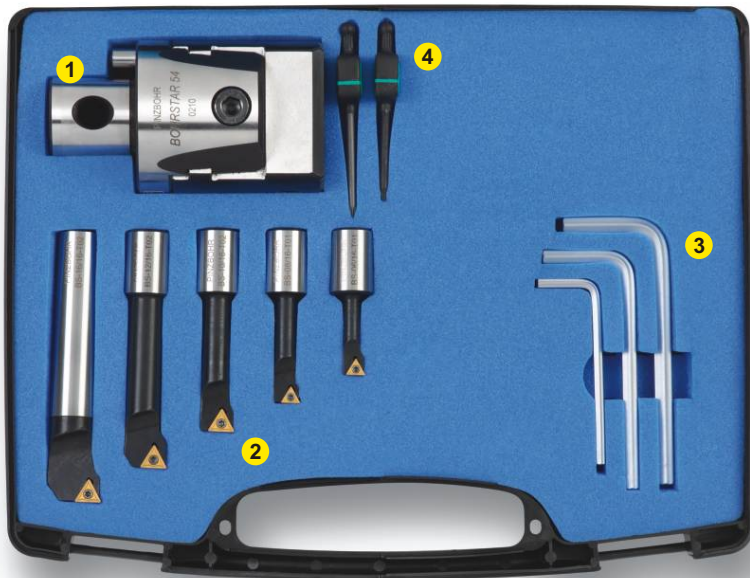

**ORDERING NUMBER:**  
**BS 54 KIT T 8-043**

	Description	Product Number	Qty.
1	Bohrstar head	BS 054 16	1
	Boring bar 6 mm.	BS 06 16 T01	1
	Boring bar 8 mm.	BS 08 16 T01	1
2	Boring bar 10 mm.	BS 10 16 T02	1
	Boring bar 12 mm.	BS 12 16 T02	1
	Boring bar 16 mm.	BS 16 16 T02	1

	Description	Product Number	Qty.
3	Hexagonal key 3	HK 030	1
	Hexagonal key 5	HK 050	1
	Hexagonal key 6	HK 060	1
4	Torx key 6	TK 06	1
	Torx key 7	TK 07	1

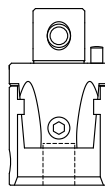

From Ø 8  
To Ø 43

# Bohrstar 54 KIT

Triangular insert 

Ø 8 - 100

[www.pinzbohr.com](http://www.pinzbohr.com)



**ORDERING NUMBER:**  
**BS 54 KIT T 8-100**

	Description	Product Number	Qty.
1	Bohrstar head	BS 054 16	1
	Boring bar 6 mm.	BS 06 16 T01	1
	Boring bar 8 mm.	BS 08 16 T01	1
2	Boring bar 10 mm.	BS 10 16 T02	1
	Boring bar 12 mm.	BS 12 16 T02	1
	Boring bar 16 mm.	BS 16 16 T02	1
3	Boring bar 34 mm.	BS 34 16 T03	1
4	Cartridge	BS 2CT T03	1
5	Location sleeve	BS 16 M10	1

	Description	Product Number	Qty.
	Hexagonal key 3	HK 030	1
6	Hexagonal key 5	HK 050	1
	Hexagonal key 6	HK 060	1
	Hexagonal key 8	HK 080	1
	Torx key 6	TK 06	1
7	Torx key 7	TK 07	1
	Torx key 8	TK 08	1
8	Cartridge screw	CS 10 25	1

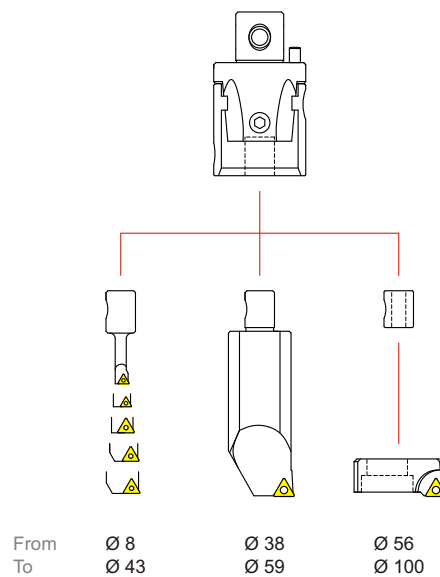



# Bohrstar 54 KIT

Triangular insert 

Ø 8 - 170

[www.pinzbohr.com](http://www.pinzbohr.com)

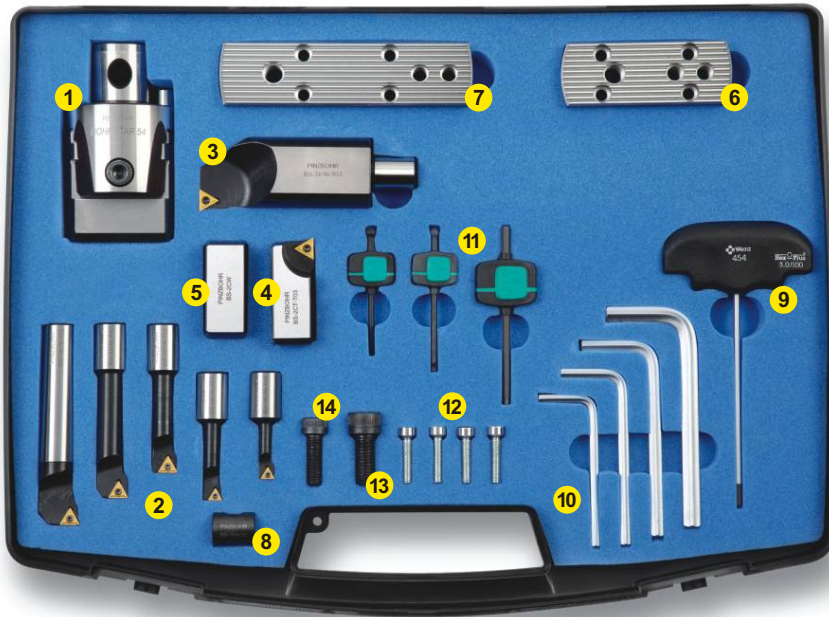

**ORDERING NUMBER:**  
BS 54 KIT T 8-170

	Description	Product Number	Qty.
1	Bohrstar head	BS 054 16	1
	Boring bar 6 mm.	BS 06 16 T01	1
	Boring bar 8 mm.	BS 08 16 T01	1
2	Boring bar 10 mm.	BS 10 16 T02	1
	Boring bar 12 mm.	BS 12 16 T02	1
	Boring bar 16 mm.	BS 16 16 T02	1
3	Boring bar 34 mm.	BS 34 16 T03	1
4	Cartridge	BS 2CT T03	1
5	Counterweight	BS 2CW	1
6	Small plate	BS SP 085 130	1
7	Medium plate	BS SP 125 170	1
8	Location sleeve	BS 16 M10	1

	Description	Product Number	Qty.
9	Adjusting key	AK 03	1
	Hexagonal key 4	HK 040	1
	Hexagonal key 5	HK 050	1
10	Hexagonal key 6	HK 060	1
	Hexagonal key 8	HK 080	1
	Torx key 6	TK 06	1
11	Torx key 7	TK 07	1
	Torx key 8	TK 08	1
12	Plate fixing screws	D 027 21	4
13	Cartridge screw	CS 10 25	1
14	Counterweight screw	CS 08 25	1

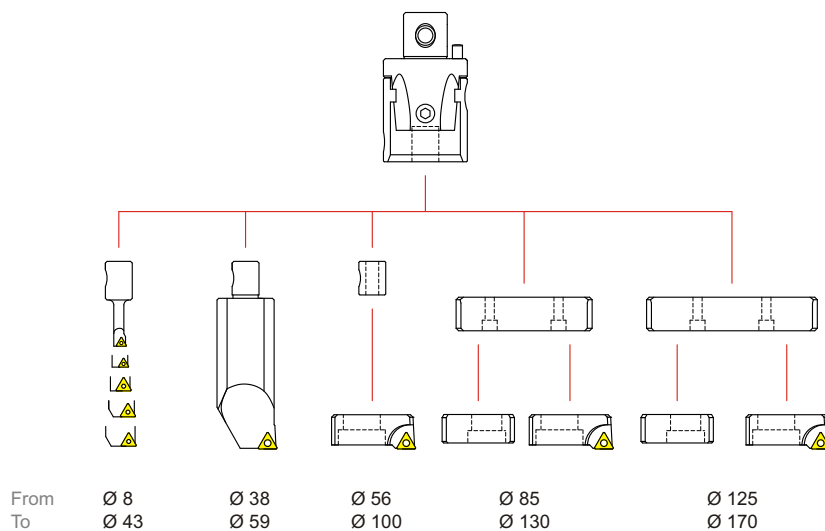



# Bohrstar 54 KIT

Triangular insert 

Ø 8 - 210

[www.pinzbohr.com](http://www.pinzbohr.com)

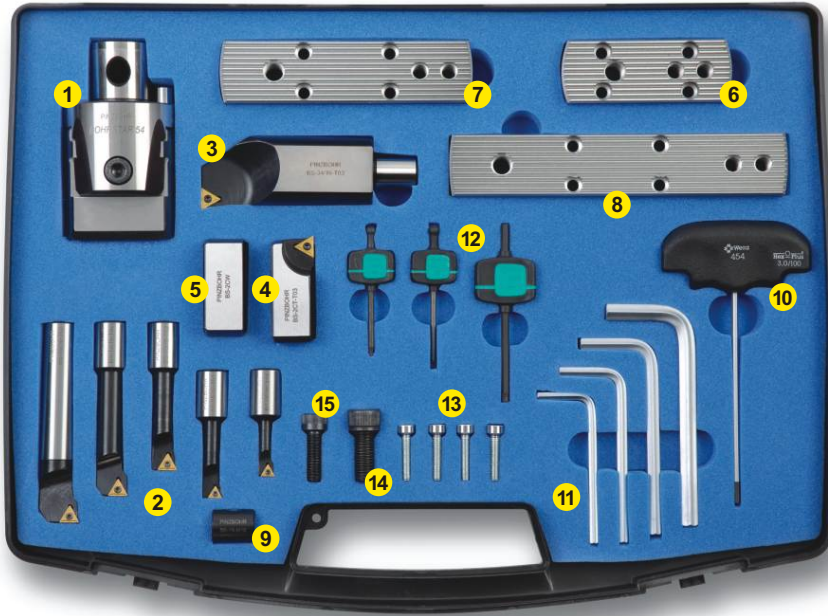

**ORDERING NUMBER:**  
**BS 54 KIT T 8-210**

	Description	Product Number	Qty.
1	Bohrstar head	BS 054 16	1
	Boring bar 6 mm.	BS 06 16 T01	1
	Boring bar 8 mm.	BS 08 16 T01	1
2	Boring bar 10 mm.	BS 10 16 T02	1
	Boring bar 12 mm.	BS 12 16 T02	1
	Boring bar 16 mm.	BS 16 16 T02	1
3	Boring bar 34 mm.	BS 34 16 T03	1
4	Cartridge	BS 2CT T03	1
5	Counterweight	BS 2CW	1
6	Small plate	BS SP 085 130	1
7	Medium plate	BS SP 125 170	1
8	Large plate	BS SP 165 210	1

	Description	Product Number	Qty.
9	Location sleeve	BS 16 M10	1
10	Adjusting key	AK 03	1
	Hexagonal key 4	HK 040	1
	Hexagonal key 5	HK 050	1
11	Hexagonal key 6	HK 060	1
	Hexagonal key 8	HK 080	1
	Torx key 6	TK 06	1
12	Torx key 7	TK 07	1
	Torx key 8	TK 08	1
13	Plate fixing screws	D 027 21	4
14	Cartridge screw	CS 10 25	1
15	Counterweight screw	CS 08 25	1

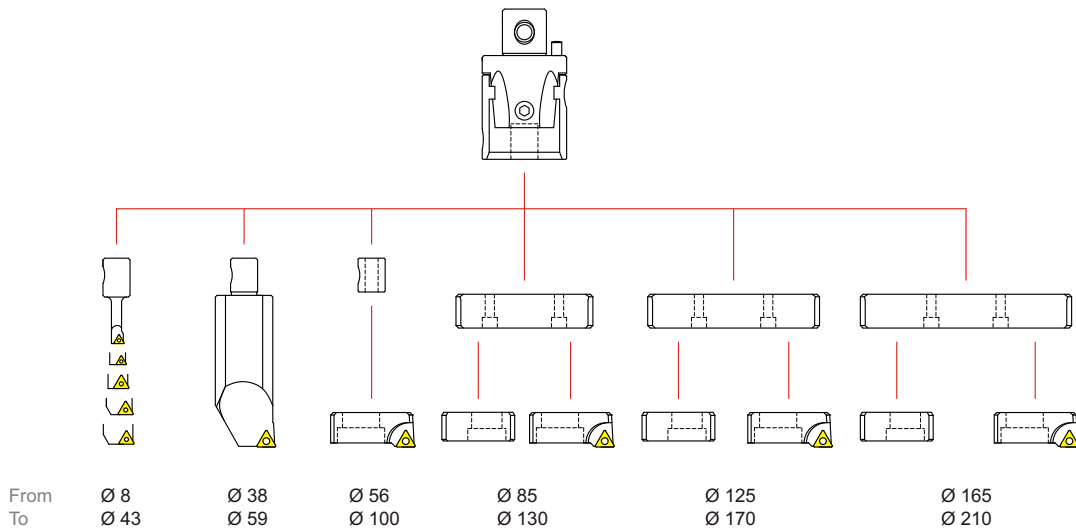

## MAS BT 403



### ISO 40

Dimension				Product Number	Kg.	Coupling Screw
$\varnothing D$	$\varnothing D_1$	L	L <sub>1</sub>			
54	28	54	27	<b>BT 340 054 090</b>	1.350	54-1220
54	28	124	97	<b>BT 340 054 160</b>	2.610	54-1220
54	28	164	137	<b>BT 340 054 200</b>	3.370	54-1220

### ISO 50

Dimension				Product Number	Kg.	Coupling Screw
$\varnothing D$	$\varnothing D_1$	L	L <sub>1</sub>			
54	28	65	27	<b>BT 350 054 090</b>	4.110	54-1220
54	28	135	97	<b>BT 350 054 160</b>	5.400	54-1220
54	28	175	137	<b>BT 350 054 200</b>	6.100	54-1220

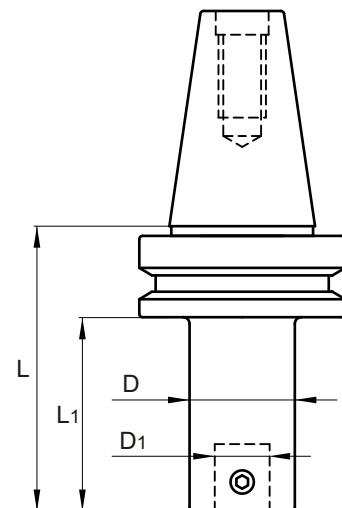

**DIN 69871**



## ISO 40

Dimension				Product Number	Kg.	Coupling Screw
øD	øD1	L	L1			
54	28	76	57	<b>AS 340 054 120</b>	1.630	54-1220
54	28	116	97	<b>AS 340 054 160</b>	2.360	54-1220
54	28	156	137	<b>AS 340 054 200</b>	3.110	54-1220

## ISO 50

Dimension				Product Number	Kg.	Coupling Screw
øD	øD1	L	L1			
54	28	62	27	<b>AS 350 054 090</b>	3.570	54-1220
54	28	132	97	<b>AS 350 054 160</b>	4.850	54-1220
54	28	172	137	<b>AS 350 054 200</b>	5.570	54-1220

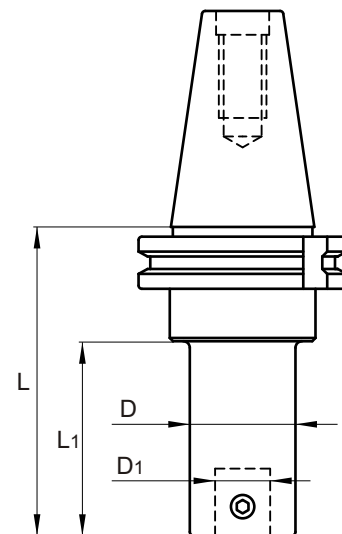

## DIN 2080



## ISO 40

Dimension				Product Number	Kg.	Coupling Screw
øD	øD1	L	L1			
54	28	39	27	<b>OTT 340 054 090</b>	1.100	54-1220
54	28	109	97	<b>OTT 340 054 160</b>	2.370	54-1220
54	28	149	137	<b>OTT 340 054 200</b>	3.140	54-1220



## ISO 50

Dimension				Product Number	Kg.	Coupling Screw
øD	øD1	L	L1			
54	28	43	27	<b>OTT 350 054 090</b>	3.100	54-1220
54	28	113	97	<b>OTT 350 054 160</b>	4.380	54-1220
54	28	153	137	<b>OTT 350 054 200</b>	5.100	54-1220

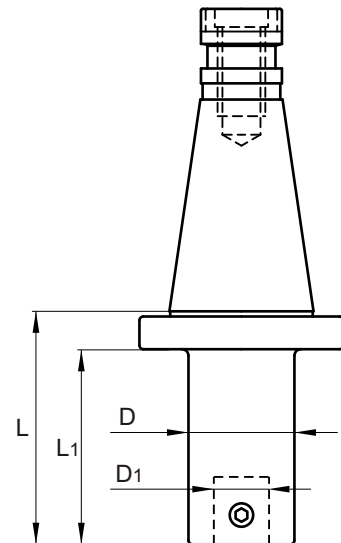

**DIN 69893**



## HSK 63

Dimension				Product Number	Kg.	Coupling Screw
$\varnothing D$	$\varnothing D_1$	L	L <sub>1</sub>			
54	28	70	44	<b>HSK 063A 054 110</b>	1.300	54-1220



## HSK 100

Dimension				Product Number	Kg.	Coupling Screw
$\varnothing D$	$\varnothing D_1$	L	L <sub>1</sub>			
54	28	73	44	<b>HSK 100A 054 110</b>	2.800	54-1220

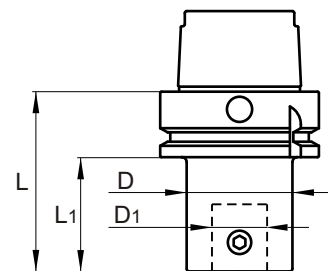

Adjusting accuracy 0.002 mm Ø

Dimension				Product Number	Kg.
øD	øD1	øD2	L		
54	28	16	65	<b>BS 054 16</b>	1.100

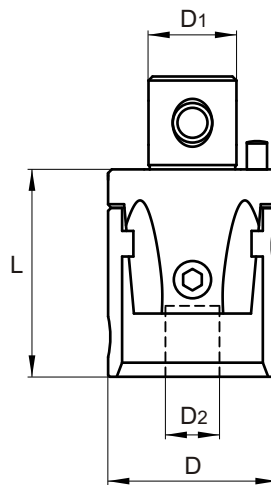

## Accessories (Optional)

### EXTENSIONS

FOR DEEPER HOLE APPLICATIONS

Dimension				Product Number	Kg.	Coupling Screw
øD	øD1	øD2	L			
54	28	28	50	<b>P 054 050</b>	0.880	54-1220
54	28	28	75	<b>P 054 075</b>	1.320	54-1220

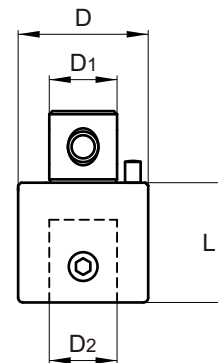

### REDUCERS

TO USE ON BIGGER DIAMETER PINZBOHR ARBORS

Dimension						Product Number	Kg.	Coupling Screw
øD	øD1	øD2	øD3	L	L1			
68	36	54	28	60	12	<b>R 068 054 072</b>	1.520	54-1220
85	50	54	28	78	12	<b>R 085 054 090</b>	2.460	54-1220

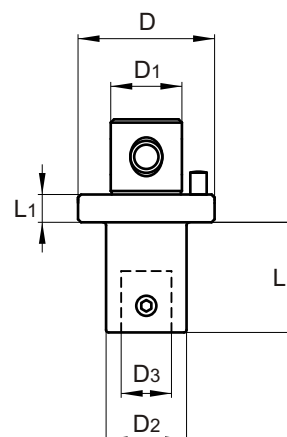



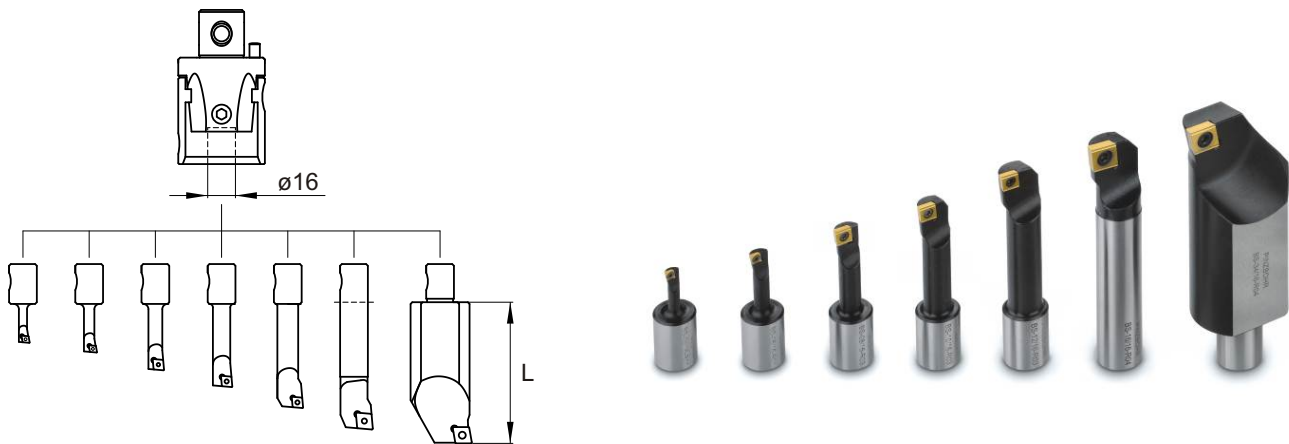

## RHOMBIC INSERT

Bore Range		L	Product Number	Insert	Kg.	Clamp Screw	Clamp Key
Min	Max						
6	28	20	<b>BS 05 16 R01</b>	EP□□ 0401□□ L	0.045	M2X3.3	TK 06
8	30	25	<b>BS 06 16 R01</b>	EP□□ 0401□□ L	0.046	M2X4	TK 06
8	30	25	<b>BS 06 16 R02</b>	EP□□ 0502□□	0.046	M2.2X5.6	TK 07
10	32	35	<b>BS 08 16 R03</b>	CC□□ 0602□□	0.054	M2.5X4.8	TK 08
13	35	45	<b>BS 10 16 R03</b>	CC□□ 0602□□	0.068	M2.5X6	TK 08
16	38	57	<b>BS 12 16 R03</b>	CC□□ 0602□□	0.090	M2.5X6	TK 08
20	43	73	<b>BS 16 16 R04</b>	CC□□ 09T3□□	0.145	M4X8.5	TK 15
38	59	82	<b>BS 34 16 R04</b>	CC□□ 09T3□□	0.450	M4X8.5	TK 15

## TRIANGULAR INSERT

Bore Range		L	Product Number	Insert	Kg.	Clamp Screw	Clamp Key
Min	Max						
8	30	25	<b>BS 06 16 T01</b>	TC□□ 06T1□□	0.046	M2X4.9	TK 06
10	32	35	<b>BS 08 16 T01</b>	TC□□ 06T1□□	0.054	M2X4.9	TK 06
13	35	45	<b>BS 10 16 T02</b>	TC□□ 0902□□	0.068	M2.2X6.4	TK 07
16	38	57	<b>BS 12 16 T02</b>	TC□□ 0902□□	0.090	M2.2X6.4	TK 07
20	43	73	<b>BS 16 16 T02</b>	TC□□ 0902□□	0.145	M2.2X6.4	TK 07
38	59	82	<b>BS 34 16 T03</b>	TP□□ 1102□□	0.450	M2.5X6	TK 08
38	59	82	<b>BS 34 16 T04</b>	TC□□ 16T3□□	0.450	M4X8.5	TK 15

► All inserts for this programme are available in our stock.

## RHOMBIC INSERT

H	L	Product Number	Insert	Kg.	Clamp Screw	Clamp Key
20	51	<b>BS 2CT R04</b>	CC□□ 09T3□□	0.100	M4X8.5	TK 15

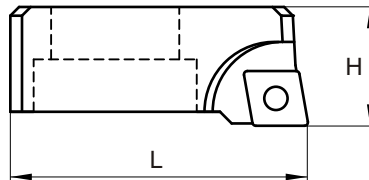

## TRIANGULAR INSERT

H	L	Product Number	Insert	Kg.	Clamp Screw	Clamp Key
20	51	<b>BS 2CT T03</b>	TP□□ 1102□□	0.100	M2.5X6	TK 08
20	51	<b>BS 2CT T04</b>	TC□□ 16T3□□	0.100	M4X8.5	TK 15

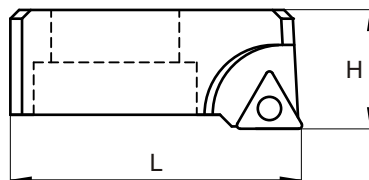

► All inserts for this programme are available in our stock.

# Counterweight

H	L	Product Number	Kg.
18.5	47	<b>BS 2CW</b>	0.110

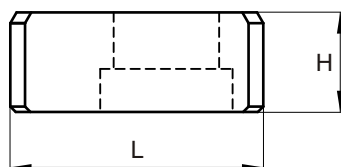

## SMALL PLATE

H	L	Product Number	Kg.
20	81	<b>BS SP 085 130</b>	0.105

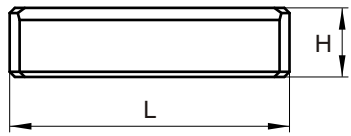
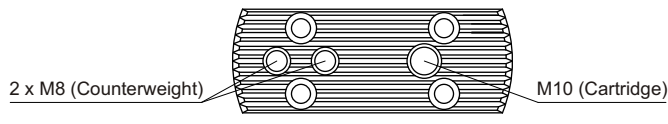

## MEDIUM PLATE

H	L	Product Number	Kg.
20	121	<b>BS SP 125 170</b>	0.170

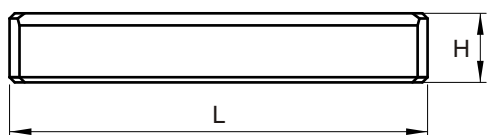
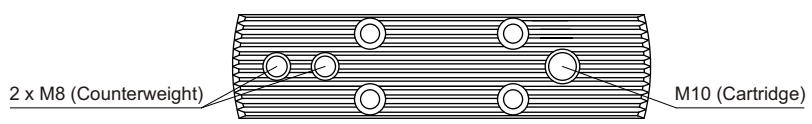

## LARGE PLATE

H	L	Product Number	Kg.
20	161	<b>BS SP 165 210</b>	0.230

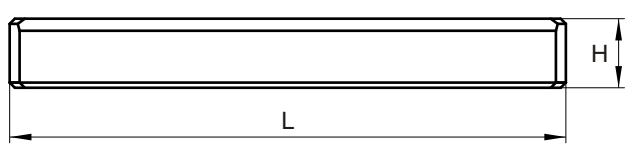
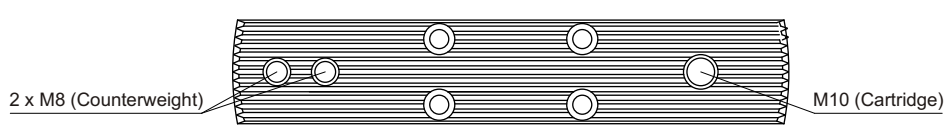



*Several hole solutions  
with only one boring head*

Distributed by: