

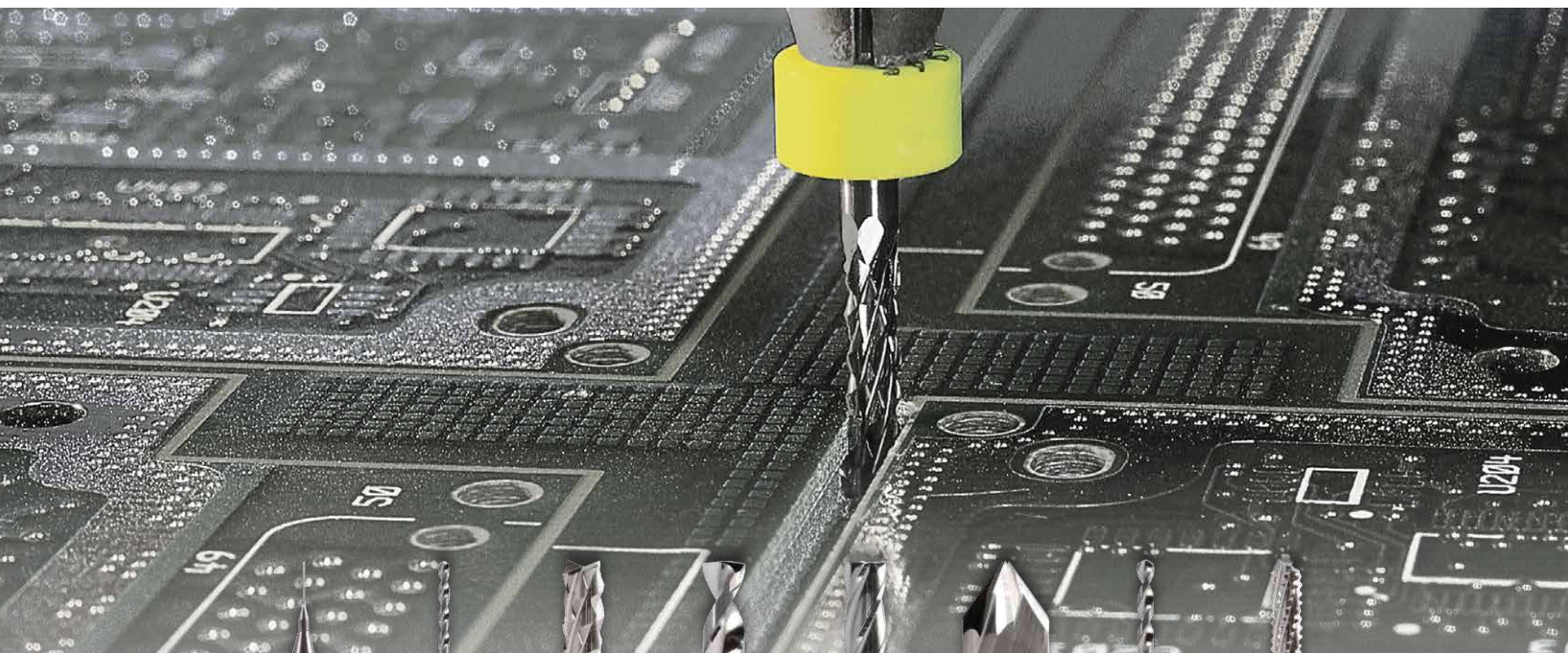

2024 | KYOCERA Precision Tools

PRINTED CIRCUIT BOARD CUTTING TOOLS CATALOG



BRILLIANT PRECISION

Manufactured with the finest carbide grades available, Kyocera's product development laboratory continually evaluates new materials from carbide manufacturers around the world. As a result, Kyocera applies the latest developments in material science to the design and manufacture of precision cutting tools.



C O N T E N T S

COMPANY OVERVIEW	ii
PRINTED CIRCUIT BOARD RESHARPENING	iii
HOW TO ORDER	v
TOOL SELECTION & APPLICATION GUIDE	vi - ix
HOW TO READ THIS CATALOG	x

DRILLS	A1 - A34
END MILLS	B1 - B12
ROUTERS	C1 - C12
SCORING / ENGRAVING / COUNTERSINKS	D1 - D4
TECHNICAL	E1 - E4
INDEX	F1 - F2

A

B

C

D

E

F



KYOCERA-SGS PRECISION TOOLS (KSPT)

KYOCERA SGS Precision Tools (KSPT) is an ISO-certified manufacturer of industry leading round solid carbide cutting tools. State of the art manufacturing and warehouse facilities have the capacity and processes to meet the quality and delivery demands of customers in all markets around the world. Complete inspections performed within its metallurgical lab and manufacturing quality departments ensure the use of high quality carbide and reliable manufacturing consistency regardless of when a cutting tool is produced. KSPT Technical Sales Engineers, Application Specialists, and Distribution Partners blanket the globe, delivering reliable service and support to all market segments.

VALUE AT THE SPINDLE®

KYOCERA SGS Precision Tools is a global leader in solid round cutting tools, thanks in part to our unrivaled portfolio of capabilities ranging from world class manufacturing centers, to vigorous research and development teams, to proprietary coatings and dependable logistics. Our dedication to bringing VALUE AT THE SPINDLE® starts with inspecting each batch of raw material, and ends with custom tooling solutions with KSPT Engineers and end users customizing tool paths, machine operation parameters, and work piece testing.

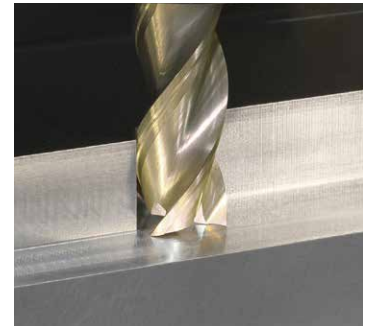

PRODUCTS



Solid Carbide End Mills



Micro Drills and End Mills

TOOL SERVICES

KSPT is committed to providing superior tooling services in the areas of Reconditioning, Recoating, Regrinding, Specials and Alterations. These services are offered to provide unique solutions and enhanced tool life with involvement from the KSPT Technical Support Team. KSPT proudly offers Tooling Services in North America and Europe.



HOW TO REACH US

KYOCERA-SGS Precision Tools

150 Marc Drive
Cuyahoga Falls, Ohio 44223

Phone: (330) 686-5700
E-mail: webmaster@kyocera-sgstool.com
Web: www.kyocera-sgstool.com

PRINTED CIRCUIT BOARD RESHARPENING

Kyocera Precision Tools was founded on the commitment to deliver the highest quality printed circuit board (PCB) tooling solutions at a lower cost to our customers. We deliver on that commitment by achieving the longest tool life in the industry. Kyocera Precision Tools was the first drill manufacturer to commit to resharpening as part of its core business.

Kyocera has developed innovations that have significantly improved the life of our resharpened tools including Kyocera pointing machines (TPM), Kyocera automated sharp point system (VISIONARE), and efficient ringsetting systems (Rodica Jr.).

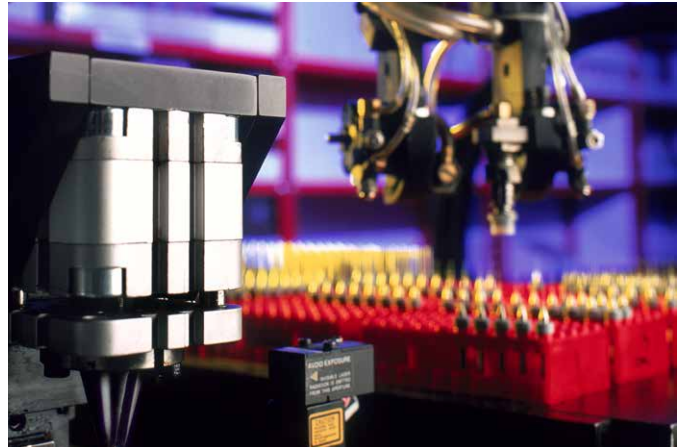
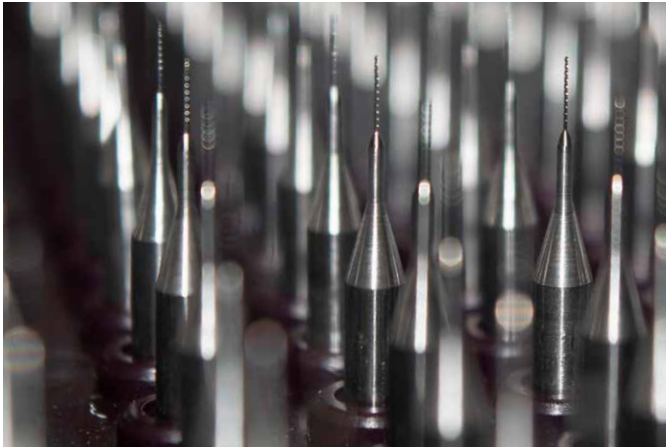

100% Robotic Handling

"from box to box" on a single machine, eliminating handling damage and ensuring precision at every step.

100% Screening of Every Tool Before Resharpening

to ensure proper geometry and confirm sufficient remaining flute length.

100% Inspection of Every Tool After Resharpening

for 11 critical attributes prior to repackaging.

100% Stock Removal Measurement

to ensure that the specified amount has been removed. Ensures quality of point while maximizing tool life.

100% Sharp Tools

ensured by an automatic 2nd pass resharpen with variable stock removal in cases where the initial specified stock removal was insufficient to achieve the desired cutting edge sharpness.

100% SPC Data Collection

with real time, machine adjustments automatically made based on trends. Extensive reporting of all data.

RESHARPENING OVERVIEW

The operator variation of a manual resharpener system when processing drills of less than 0.020" diameter has been replaced with an optical image recognition and analysis system. The VISIONARE patented optical system achieves the industry's best Gage R&R results.

The patented optical image capture and measurement system is used at two key process points.

Prior to grinding, each tool is confirmed for diameter, "Box to Box" Robotic Handling geometry, and to have sufficient remaining flute length. Digital images from the tip and flute align the drill bit into position.



"Box to Box" Robotic Handling

PRE-GRIND SCREENING AND ALIGNMENT

Prior to grinding, each tool is confirmed for diameter, "Box to Box" Robotic Handling geometry, and to have sufficient remaining flute length. Digital images from the tip and flute align the drill bit into position.

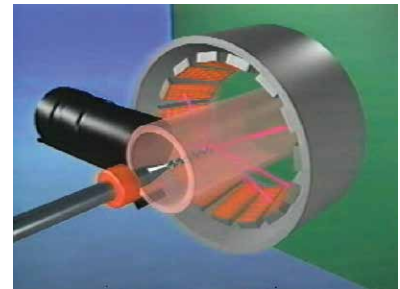

Patented Digital Optics

POST-GRIND POINT GEOMETRY INSPECTION

Each tool receives 100% point geometry inspection for 11 attributes to ensure compliance to the specification prior to repackaging packaging.

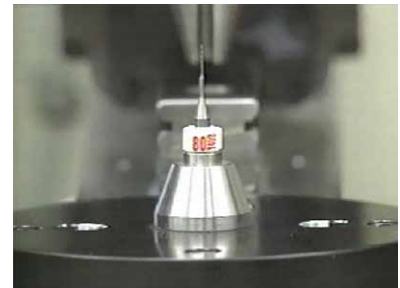

Patented Ringset Technology

OPTICAL IMAGE CAPTURE AND ANALYSIS OF EACH TOOL

Each tool receives 100% point geometry inspection for 11 attributes to ensure compliance to the specification prior to repackaging packaging.

Pre-Grind

- Diameter
- Point Angle
- Margin Width
- Helix Angle
- Overall Length

Post-Grind

- Diameter
- Gap/Overlap
- Flare/Negative
- Offcenter
- Offset
- Cutting Edge Chips
- Round Corner
- Stock Removal
- Overall Length

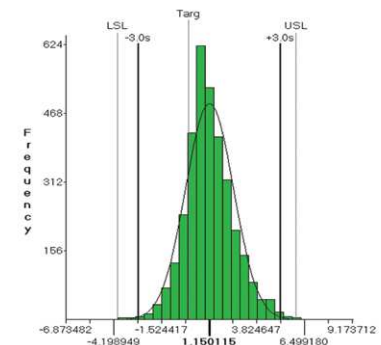

SPC Data Control

Measured data is collected and analyzed using real time SPC logic control. The closed loop quality system, exclusive to VISIONARE, is programmed to stop the process in reaction to trend data or out-of-control data points, consistent with traditional rules of statistical process control.

VISIT US ONLINE

WWW.KYOCERAPRECISIONTOOLS.COM

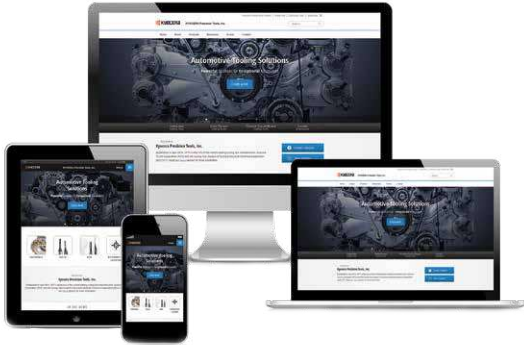

BUILT FOR SPEED AND OPTIMIZATION ACROSS ALL DEVICES

- Easy to navigate, sliding mobile menus
- Find the information you need faster than ever
- Easy-to-read articles transformed on mobile devices
- Fast load times allow you to browse products without waiting
- View and download digital product brochures and catalogs
- Locate distributors in your area on-the-go through our distributor map

How to Order

Kyocera Precision Tools' high-performance lineup of indexable and solid round cutting tools can be purchased through our vast North American Distribution network.



Contact Us

CUSTOMER SERVICE

1-888-848-9266

OR

001-714-428-3611

Monday - Friday

5:00AM - 4:30PM (PST)

8:00AM - 7:30PM (EST)













CUSTOMER SERVICE

pcb.cs@kyocerapcb.com

Stock Status Symbols

- Indicates that an item is a **Standard Item** and is available to order. If there is stock in the U.S., items will ship the same day if ordered by 4:30pm (EST).
- △ Indicates that an item is being phased out of production. Please contact your local Kyocera sales engineer to determine a replacement solution.

Tool Selection & Application Guide

Tool Type	Ref. Page	Series	Product Description	Shape (Not Actual Tool Size)	No. of Flutes	Cutting Diameter Range
Drills	A2	100	Medium Non-Undercut Drills		2	0.0200" - 0.1250" 0.50mm - 3.15mm
	A7	102	HDI /Blind Via Two Flute Tapered Non-Undercut Drills		2	0.10mm - 0.70mm
	A9	150	Large Non-Undercut Drills		2	0.1285" - 0.2610" 3.20mm - 6.70mm
	A13	240	Flex Circuits Straight Non-Undercut Drills		2	0.0380" 0.15mm - 1.00mm
	A14	260	Back Drill Non-Undercut Drills		2	0.0145" - 0.0420" 0.40mm - 1.00mm
	A15	405	Pilot Short Flute Undercut Drills		2	0.0228" - 0.0330" 0.10mm - 1.15mm
	A16	430	Elevated Overall Performance Two into One Hybrid Flute Undercut Drills		2	0.0071" - 0.0145" 0.10mm - 1.00mm
	A21	460	Superior Hole Wall Quality Standard Flute Undercut Drills		2	0.0091" - 0.0145" 0.15mm - 0.65mm
	A21	480	Superior Hole Wall Quality Extended Flute Undercut Drills		2	0.0110" - 0.0520" 0.15mm - 3.15mm
	A28	560	Accuracy Oriented Standard Flute Non-Undercut Drills		2	0.0040" - 0.0145" 0.20mm - 0.45mm
	A29	580	Accuracy Oriented Extended Flute Non-Undercut Drills		2	0.0071" - 0.0180" 0.10mm - 0.45mm
	A30	700	Reduced Deflection Non-Undercut Slot Drills		2	0.0160" - 0.0520" 0.55mm - 1.15mm
	A32	750	Reduced Deflection Extended Flute Non-Undercut Slot Drills		2	0.0420" - 0.0465" 0.95mm - 2.00mm















*Series 100 drills > 2.00mm in diameter can be used to drill slots
 All products are manufactured with a 3.17mm (1/8") shank
 See product page for high performance features.

Tool Selection & Application Guide

Ref. Page	Series	Product Description	Hole Location Accuracy	Hole Wall Quality	Stack Height	Repoint Layer	Layer Count	Slot Drilling	Back Panel Drilling	
A2	100	Medium Non-Undercut Drills	Standard	Standard	Standard	Standard	Standard	Yes*	Yes	
A7	102	HDI /Blind Via Two Flute Tapered Non-Undercut Drills	Superior	High	-	-	-	-	-	
A9	150	Large Non-Undercut Drills	All Applications							
A13	240	Flex Circuits Straight Non-Undercut Drills	Standard	Superior	Standard	Standard	High	-	-	
A14	260	Back Drill Non-Undercut Drills	Standard	Superior	Standard	Standard	High	-	-	
A14	405	Pilot Short Flute Undercut Drills	Superior	-	-	-	-	-	-	
A16	430	Elevated Overall Performance Two into One Hybrid Flute Undercut Drills	Superior	Superior	High	Extended	High	-	Yes	
A21	460	Superior Hole Wall Quality Standard Flute Undercut Drills	Superior	Superior	Standard	Limited	High	-	-	
A21	480	Superior Hole Wall Quality Extended Flute Undercut Drills	Standard	Superior	High	Limited	High	-	Yes	
A28	560	Accuracy Oriented Standard Flute Non-Undercut Drills	Superior	Standard	Standard	Standard	Standard	-	-	
A29	580	Accuracy Oriented Extended Flute Non-Undercut Drills	Standard	Standard	High	Standard	Standard	-	-	
A30	700	Reduced Deflection Non-Undercut Slot Drills	-	-	High (0.50mm-3.17mm)	Standard (0.50mm-3.17mm)	High (0.50mm-3.17mm)	Yes	Yes (0.50mm-3.17mm)	
A32	750	Reduced Deflection Extended Flute Non-Undercut Slot Drills	-	-	High (0.50mm-3.17mm)	Standard (0.50mm-3.17mm)	High (0.50mm-3.17mm)	Yes	Yes (0.50mm-3.17mm)	

*Series 100 drills > 2.00mm in diameter can be used to drill slots
 All products are manufactured with a 3.17mm (1/8") shank
 See product page for high performance features.

Tool Selection & Application Guide

Tool Type	Ref. Page	Series	Product Description	Shape (Not Actual Tool Size)	No. of Flutes	Cutting Diameter Range
End Mills	B2	1500	One Flute End Mills for Soft Materials		1	0.0312" - 0.1250" 1.27mm ~ 2.00mm
	B3	1560	One Flute End Mills for Flexible Laminates		1	0.80mm - 2.00mm
	B4	1600	Two Flute End Mills		2	0.0312" - 0.1250" 0.30mm - 3.00mm
	B6	1603	Two Flute Flat Point End Mills		2	0.0625" - 0.1250" 1.20mm
	B7	1660	Two Flute End Mills for Flexible Laminates		2	0.80mm - 1.60mm
	B8	1730	Three Flute Zero Helix No End style (Safe End) End Mills		3	0.80mm - 2.40mm
	B9	1735	Three Flute End Mills for Clean Edges		3	0.1250" 0.80mm - 2.40mm
	B12	1800	Four Flute End Mills		4	0.0625" - 0.1250"
Routers	C2	1300	Premium Edge Routers		2	1.60mm - 2.40mm
	C3	2300	Chipbreaker Routers		2	0.0500" - 0.1250" 0.50mm - 3.00mm
	C5	2350	Low Fracture Routers		2	0.80mm - 2.40mm
	C8	2390	Flash Routers		2	0.0938" - 0.1250"
	C9	4100	Cross Cut Routers		2	0.0625" - 0.1250" 0.50mm - 2.60mm
Scoring & Engraving	D2	2002	Two Flute Scoring & Engraving Tools		2	0.1250" 3.00mm
Countersinks	D3	2000	One Flute Countersinks		1	0.2500"
	D4	2400	Four Flute Countersinks		4	0.2500" - 0.6250"

*Series 1735 End Mill End Style allows surface milling and plunging.
All products are manufactured with a 3.17mm (1/8") shank
See product page for high performance features.

Tool Selection & Application Guide

Ref. Page	Series	Product Description	Edge Finish	Material Application	Controlled Depth Mill	Gold Edges	Plated Slots (<2xD)	Flash Removal
B2	1500	One Flute End Mills for Soft Materials	Superior	Soft (PTFE, Flex, Metal)	-	-	-	-
B3	1560	One Flute End Mills for Flexible Laminates	Superior	Flex	-	-	-	-
B4	1600	Two Flute End Mills	Superior	Soft (PTFE, Flex, Metal)	Yes	Yes	Yes	-
B6	1603	Two Flute Flat Point End Mills	Superior	Soft (PTFE, Flex, Metal)	Yes	Yes	Yes	-
B7	1660	Two Flute End Mills for Flexible Laminates	Superior	Flex	-	-	-	-
B8	1730	Three Flute Zero Helix No End style (Safe End) End Mills	Superior	Soft (PTFE, Flex, Metal)	-	Yes	-	-
B9	1735	Three Flute End Mills for Clean Edges	Superior	All	Yes	Yes	Yes	-
B12	1800	Four Flute End Mills	Superior	Soft (PTFE, Flex, Metal)	-	-	Yes	-
C2	1300	Premium Edge Routers	Superior	-	-	Yes	-	-
C3	2300	Chipbreaker Routers	Standard	Standard	-	-	-	-
C5	2350	Low Fracture Routers	Superior	Brittle	-	-	-	-
C8	2390	Flash Routers	Standard	All	-	-	-	Yes
C9	4100	Cross Cut Routers	Standard	Standard	-	-	-	-
D2	2002	Two Flute Scoring & Engraving Tools	Superior	Standard	Yes	Yes	-	-
D3	2000	One Flute Countersinks	Superior	All	-	-	-	-
D3	2400	Four Flute Countersinks	Standard	All	-	-	-	-

*Series 1735 End Mill End Style allows surface milling and plunging.
 All products are manufactured with a 3.17mm (1/8") shank
 See product page for high performance features.

How to Read This Catalog

Use the guide below to better understand how to read the contents of each page. Pages will vary throughout but will remain close to this guide overall.

Tooling Category
Dimensions Diagram
Tool Series

Non-Undercut Drills
Series 100

Medium Non-Undercut Drills

Diameter Range
0.0670" ~ 0.1250"

EXTENDED Flute Length (Inch)

Part Number	Stock	Drill Size	Dimensions (in)		Point Angle
			Cutting Diameter	Flute Length	
100.0670.400	●	#51	0.0670	0.4000	130°
100.0700.400	●	#50	0.0700	0.4000	130°
100.0730.400	●	#49	0.0730	0.4000	130°
100.0760.400	●	#48	0.0760	0.4000	130°
100.0781.400	●	5/64"	0.0781	0.4000	130°
100.0785.400	●	#47	0.0785	0.4000	130°
100.0810.400	●	#46	0.0810	0.4000	130°
100.0820.400	●	#45	0.0820	0.4000	130°
100.0860.400	●	#44	0.0860	0.4000	130°
100.0890.400	●	#43	0.0890	0.4000	130°
100.0935.400	●	#42	0.0935	0.4000	130°
100.0938.400	●	3/32"	0.0938	0.4000	130°
100.0960.400	●	#41	0.0960	0.4000	130°
100.0980.400	●	#40	0.0980	0.4000	130°
100.0995.400	●	#39	0.0995	0.4000	130°
100.1015.400	●	#38	0.1015	0.4000	165°
100.1040.400	●	#37	0.1040	0.4000	165°
100.1065.400	●	#36	0.1065	0.4000	165°
100.1094.400	●	7/64"	0.1094	0.4000	165°
100.1100.400	●	#35	0.1100	0.4000	165°
100.1110.400	●	#34	0.1110	0.4000	165°
100.1130.400	●	#33	0.1130	0.4000	165°
100.1160.400	●	#32	0.1160	0.4000	165°
100.1200.400	●	#31	0.1200	0.4000	165°
100.1250.394	●	1/8"	0.1250	0.3940	130°
100.1250.400	●	1/8"	0.1250	0.4000	165°

Small and medium sized drills with extended flute lengths capable of drilling medium and high stacks for improved utilization.

For recommended cutting conditions please visit:
www.kyoceraprecisiontools.com/pcb/speeds-feeds

● : U.S. Stock Standard
■ : NOT STOCKED - Call for Delivery
▲ : Coming Soon

(U.S.) 1.888.848.8268
(International) 001.714.428.7777
Visit us online at KyoceraPrecisionTools.com

KYOCERA A3

Tool Attributes Icon Glossary

Below is a list of icons used to describe specific tool characterizations throughout the catalog for a quick understanding of the tool's attributes or advantages. Icons will vary based on the tool that is represented. Below are examples.

- Number of Flutes (2)
- Right-Hand Tool
- 130° Included Point Angle
- 30° Helix Angle

X

DRILLS



A1 - A34

Drills	A1 - A34
Series 100 - Medium Non-Undercut Drills	A3
Series 102 - Two Flute Tapered Non-Undercut Drills	A7
Series 150 - Large Non-Undercut Drills	A9
Series 240 - Straight Non-Undercut Drills for Flex Circuits	A13
Series 260 - Back Non-Undercut Drills	A14
Series 405 - Short Flute Pilot Undercut Drills	A15
Series 430 - Two into One Flute Hybrid Undercut Drills	A16
Series 460 / 480 - Superior Hole Wall Quality Undercut Drills	A21
Series 560 / 580 - Accuracy Oriented Non-Undercut Drills	A28
Series 700 / 750 - Reduced Deflection Slot Non-Undercut Drills	A30

Medium Non-Undercut Drills

Diameter Range
0.0200" - 0.0635"

A
DRILLS



Small and medium sized drills with extended flute lengths capable of drilling medium and high stacks for improved utilization.

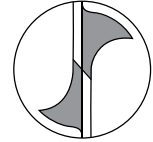
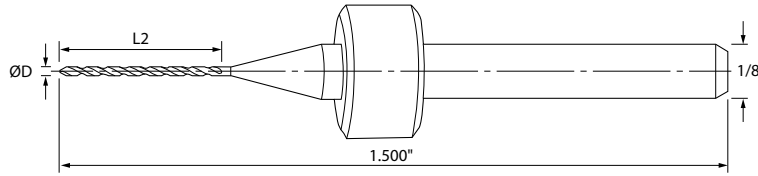

4 Facet Point Geometry



EXTENDED Flute Length (Inch)

Part Number	Stock	Drill Size	Dimensions (in)		Point Angle
			Cutting Diameter	Flute Length	
			ØD	L2	
100.0200.360	●	#76	0.0200	0.3600	130°
100.0210.360	●	#75	0.0210	0.3600	130°
100.0225.360	●	#74	0.0225	0.3600	130°
100.0240.400	●	#73	0.0240	0.4000	130°
100.0250.400	●	#72	0.0250	0.4000	130°
100.0260.400	●	#71	0.0260	0.4000	130°
100.0280.400	●	#70	0.0280	0.4000	130°
100.0292.400	●	#69	0.0292	0.4000	130°
100.0310.400	●	#68	0.0310	0.4000	130°
100.0320.400	●	#67	0.0320	0.4000	130°
100.0330.400	●	#66	0.0330	0.4000	130°
100.0350.400	●	#65	0.0350	0.4000	130°
100.0360.400	●	#64	0.0360	0.4000	130°
100.0370.400	●	#63	0.0370	0.4000	130°
100.0380.400	●	#62	0.0380	0.4000	130°
100.0390.400	●	#61	0.0390	0.4000	130°
100.0400.400	●	#60	0.0400	0.4000	130°
100.0410.400	●	#59	0.0410	0.4000	130°
100.0420.400	●	#58	0.0420	0.4000	130°
100.0430.400	●	#57	0.0430	0.4000	130°
100.0465.400	●	#56	0.0465	0.4000	130°
100.0520.400	●	#55	0.0520	0.4000	130°
100.0550.400	●	#54	0.0550	0.4000	130°
100.0595.400	●	#53	0.0595	0.4000	130°
100.0625.400	●	1/16"	0.0625	0.4000	130°
100.0635.400	●	#52	0.0635	0.4000	130°

Part Numbers above include rings set at 0.800" - For Ringless Part Number, replace series "." with "-" (XXX-XXXX.XXXX)
Additional diameters and special ring colors available upon request.

For recommended cutting conditions please visit:
www.kyoceraprecisiontools.com/pcb/speeds-feeds

1-888-848-9266

OR

001-714-428-3611

Visit us online at KyoceraPrecisionTools.com

Medium Non-Undercut Drills

Diameter Range
0.0670" ~ 0.1250"

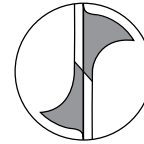
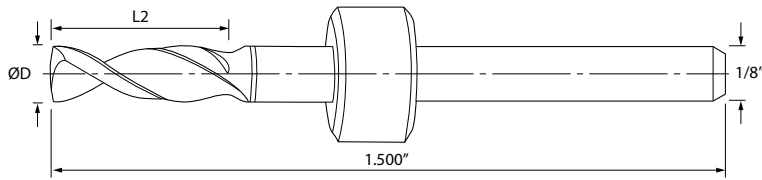

4 Facet Point Geometry



EXTENDED Flute Length (Inch)

Part Number	Stock	Drill Size	Dimensions (in)		Point Angle
			Cutting Diameter	Flute Length	
			ØD	L2	
100.0670.400	●	#51	0.0670	0.4000	130°
100.0700.400	●	#50	0.0700	0.4000	130°
100.0730.400	●	#49	0.0730	0.4000	130°
100.0760.400	●	#48	0.0760	0.4000	130°
100.0781.400	●	5/64"	0.0781	0.4000	130°
100.0785.400	●	#47	0.0785	0.4000	130°
100.0810.400	●	#46	0.0810	0.4000	130°
100.0820.400	●	#45	0.0820	0.4000	130°
100.0860.400	●	#44	0.0860	0.4000	130°
100.0890.400	●	#43	0.0890	0.4000	130°
100.0935.400	●	#42	0.0935	0.4000	130°
100.0938.400	●	3/32"	0.0938	0.4000	130°
100.0960.400	●	#41	0.0960	0.4000	130°
100.0980.400	●	#40	0.0980	0.4000	130°
100.0995.400	●	#39	0.0995	0.4000	130°
100.1015.400	●	#38	0.1015	0.4000	165°
100.1040.400	●	#37	0.1040	0.4000	165°
100.1065.400	●	#36	0.1065	0.4000	165°
100.1094.400	●	7/64"	0.1094	0.4000	165°
100.1100.400	●	#35	0.1100	0.4000	165°
100.1110.400	●	#34	0.1110	0.4000	165°
100.1130.400	●	#33	0.1130	0.4000	165°
100.1160.400	●	#32	0.1160	0.4000	165°
100.1200.400	●	#31	0.1200	0.4000	165°
100.1250.394	●	1/8"	0.1250	0.3940	130°
100.1250.400	●	1/8"	0.1250	0.4000	165°



Small and medium sized drills with extended flute lengths capable of drilling medium and high stacks for improved utilization.

DRILLS	A
END MILLS	B
ROUTERS	C
SCORING/ENGRAVING COUNTERSINKS	D
TECHNICAL	E
INDEX	F



Part Numbers above include rings set at 0.800" - For Ringless Part Number, replace series "." with "-" (XXX-XXXX.XXXX)
Additional diameters and special ring colors available upon request.



For recommended cutting conditions please visit:
www.kyoceraprecisiontools.com/pcb/speeds-feeds

1-888-848-9266

OR

001-714-428-3611

Visit us online at KyoceraPrecisionTools.com

● : U.S. Standard Item

Medium Non-Undercut Drills

Diameter Range
0.50mm ~ 1.55mm

A
DRILLS



Small and medium sized drills with extended flute lengths capable of drilling medium and high stacks for improved utilization.

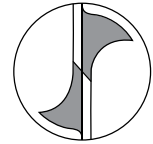
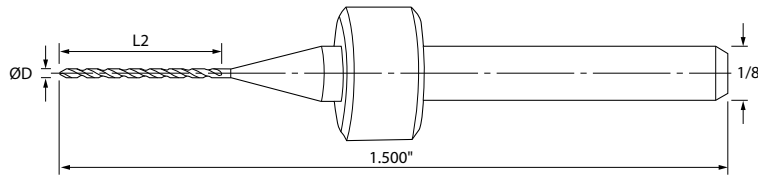

4 Facet Point Geometry



EXTENDED Flute Length (Metric)

Part Number	Stock	Drill Size	Dimensions (mm)		Point Angle
			Cutting Diameter	Flute Length	
			ØD	L2	
100.0197.360	●	0.50mm	0.500	9.14	130°
100.0217.360	●	0.55mm	0.550	9.14	130°
100.0236.360	●	0.60mm	0.600	9.14	130°
100.0256.400	●	0.65mm	0.650	10.16	130°
100.0276.400	●	0.70mm	0.700	10.16	130°
100.0295.400	●	0.75mm	0.750	10.16	130°
100.0315.400	●	0.80mm	0.800	10.16	130°
100.0335.400	●	0.85mm	0.850	10.16	130°
100.0354.400	●	0.90mm	0.900	10.16	130°
100.0374.400	●	0.95mm	0.950	10.16	130°
100.0394.400	●	1.00mm	1.000	10.16	130°
100.0413.400	●	1.05mm	1.050	10.16	130°
100.0433.400	●	1.10mm	1.100	10.16	130°
100.0441.400	●	1.12mm	1.120	10.16	130°
100.0453.400	●	1.15mm	1.150	10.16	130°
100.0472.400	●	1.20mm	1.200	10.16	130°
100.0492.400	●	1.25mm	1.250	10.16	130°
100.0512.400	●	1.30mm	1.300	10.16	130°
100.0531.400	●	1.35mm	1.350	10.16	130°
100.0551.400	●	1.40mm	1.400	10.16	130°
100.0571.400	●	1.45mm	1.450	10.16	130°
100.0591.400	●	1.50mm	1.500	10.16	130°
100.0610.400	●	1.55mm	1.550	10.16	130°



Part Numbers above include rings set at 0.800" - For Ringless Part Number, replace series "." with "-" (XXX-XXXX.XXXX)
Additional diameters and special ring colors available upon request.



For recommended cutting conditions please visit:
www.kyoceraprecisiontools.com/pcb/speeds-feeds

Medium Non-Undercut Drills

Diameter Range
1.60mm ~ 2.60mm

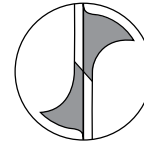
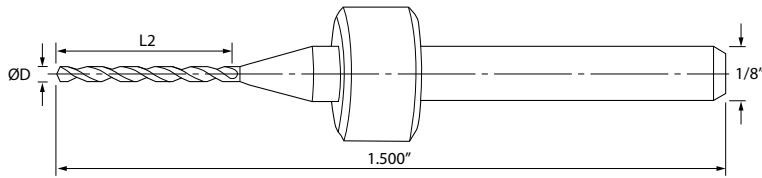

4 Facet Point Geometry



EXTENDED Flute Length (Metric)

Part Number	Stock	Drill Size	Dimensions (mm)		Point Angle
			Cutting Diameter	Flute Length	
			ØD	L2	
100.0630.400	●	1.60mm	1.600	10.16	130°
100.0650.400	●	1.65mm	1.650	10.16	130°
100.0669.400	●	1.70mm	1.700	10.16	130°
100.0689.400	●	1.75mm	1.750	10.16	130°
100.0709.400	●	1.80mm	1.800	10.16	130°
100.0728.400	●	1.85mm	1.850	10.16	130°
100.0748.400	●	1.90mm	1.900	10.16	130°
100.0768.400	●	1.95mm	1.950	10.16	130°
100.0787.400	●	2.00mm	2.000	10.16	130°
100.0807.400	●	2.05mm	2.050	10.16	130°
100.0827.400	●	2.10mm	2.100	10.16	130°
100.0846.400	●	2.15mm	2.150	10.16	130°
100.0866.400	●	2.20mm	2.200	10.16	130°
100.0886.400	●	2.25mm	2.250	10.16	130°
100.0906.400	●	2.30mm	2.300	10.16	130°
100.0925.400	●	2.35mm	2.350	10.16	130°
100.0945.400	●	2.40mm	2.400	10.16	130°
100.0965.400	●	2.45mm	2.451	10.16	130°
100.0984.400	●	2.50mm	2.500	10.16	130°
100.1004.394	●	2.55mm	2.550	10.00	130°
100.1004.400	●	2.55mm	2.550	10.16	165°
100.1024.394	●	2.60mm	2.600	10.00	130°
100.1024.400	●	2.60mm	2.600	10.16	165°



Small and medium sized drills with extended flute lengths capable of drilling medium and high stacks for improved utilization.



Part Numbers above include rings set at 0.800" - For Ringless Part Number, replace series "." with "-" (XXX-XXXX.XXXX)
Additional diameters and special ring colors available upon request.



For recommended cutting conditions please visit:
www.kyoceraprecisiontools.com/pcb/speeds-feeds

DRILLS	A
END MILLS	B
ROUTERS	C
SCORING/ENGRAVING COUNTERSINKS	D
TECHNICAL	E
INDEX	F

Medium Non-Undercut Drills

Diameter Range
2.65mm ~ 3.15mm

A
DRILLS



Small and medium sized drills with extended flute lengths capable of drilling medium and high stacks for improved utilization.

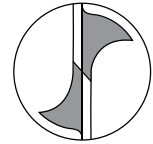
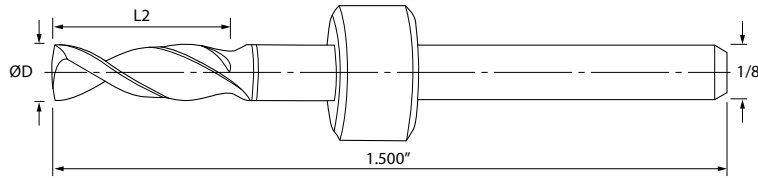

4 Facet Point Geometry



EXTENDED Flute Length (Metric)

Part Number	Stock	Drill Size	Dimensions (mm)		Point Angle
			Cutting Diameter	Flute Length	
			ØD	L2	
100.1043.394	●	2.65mm	2.649	10.00	130°
100.1043.400	●	2.65mm	2.649	10.16	165°
100.1063.394	●	2.70mm	2.700	10.00	130°
100.1063.400	●	2.70mm	2.700	10.16	165°
100.1083.394	●	2.75mm	2.750	10.00	130°
100.1083.400	●	2.75mm	2.750	10.16	165°
100.1102.394	●	2.80mm	2.800	10.00	130°
100.1102.400	●	2.80mm	2.800	10.16	165°
100.1122.394	●	2.85mm	2.850	10.00	130°
100.1122.400	●	2.85mm	2.850	10.16	165°
100.1142.394	●	2.90mm	2.900	10.00	130°
100.1142.400	●	2.90mm	2.900	10.16	165°
100.1161.394	●	2.95mm	2.950	10.00	130°
100.1161.400	●	2.95mm	2.950	10.16	165°
100.1181.394	●	3.00mm	3.000	10.00	130°
100.1181.400	●	3.00mm	3.000	10.16	165°
100.1201.394	●	3.05mm	3.050	10.00	130°
100.1201.400	●	3.05mm	3.050	10.16	165°
100.1220.394	●	3.10mm	3.100	10.00	130°
100.1220.400	●	3.10mm	3.100	10.16	165°
100.1240.394	●	3.15mm	3.150	10.00	130°
100.1240.400	●	3.15mm	3.150	10.16	165°

Part Numbers above include rings set at 0.800" - For Ringless Part Number, replace series "." with "-" (XXX-XXXX.XXXX)
Additional diameters and special ring colors available upon request.

For recommended cutting conditions please visit:
www.kyoceraprecisiontools.com/pcb/speeds-feeds

1-888-848-9266
OR

001-714-428-3611

Visit us online at KyoceraPrecisionTools.com

Series 102

HDI Drill Product Line

Kyocera Precision Tools is committed to continuous improvement in all of its product offerings, particularly when faced with new PCB applications and materials. In order to meet these new challenges, Kyocera Precision Tools is pleased to introduce its new product to address HDI applications, Series 102 Drill product series. The new design demonstrates improved hole wall and top surface quality. Series 102 is a two flute product which has a designed side taper, promoting superior plating capability. This document details the product line developed in the Kyocera Precision Tools Development Lab in order to demonstrate to the PCB market the high performance of this new product.

Series 102 Design

Series 102 has a several design features promoting excellence in producing HDI type holes in PCB materials. The design is highlighted by:

- Tapered cutting body producing a tapered hole leading to high plating reliability
- High point angle resulting in a relative flat bottom for precise hole placement and high plating integrity
- Cutting length designed to meet typical HDI demands
- Diameters available for wide range of applications

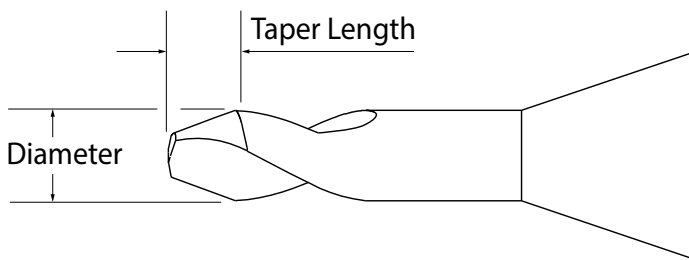

Series 102 Performance

Lab and beta site tests were conducted to ensure the product performed at an improved level that is both reliable and repeatable.

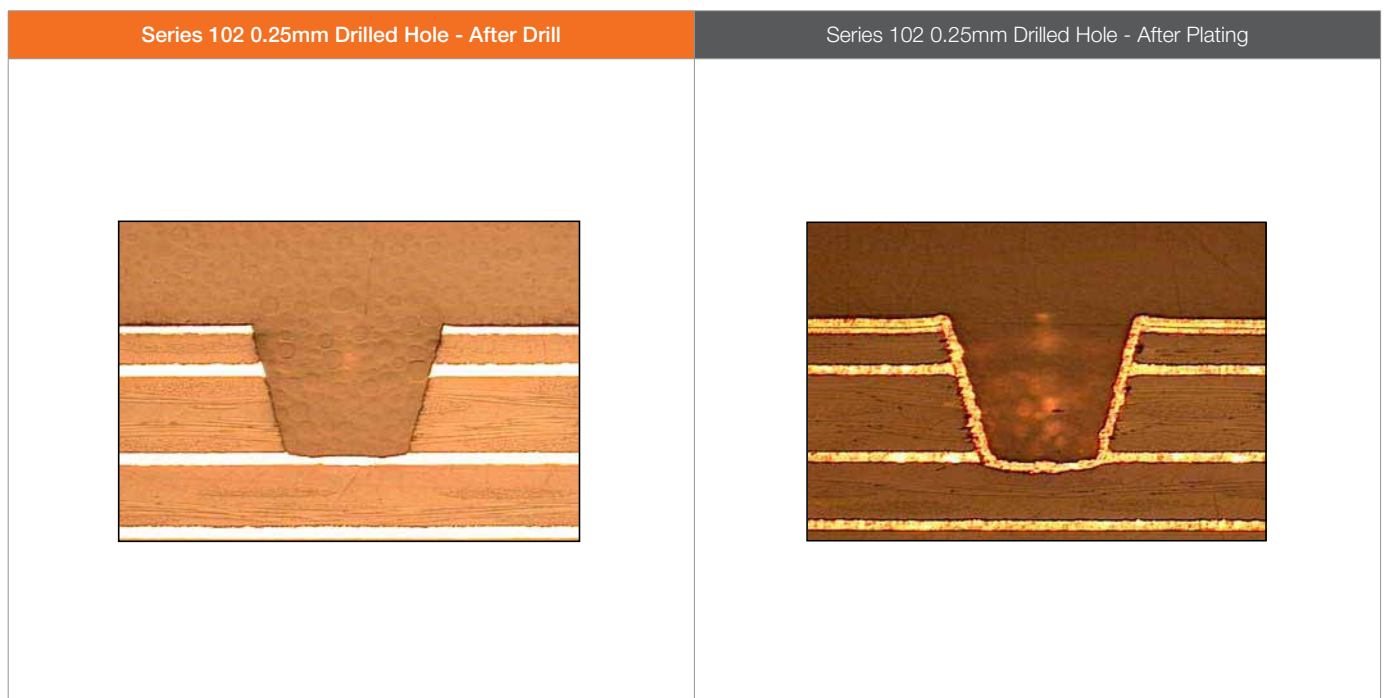

DRILLS	A
END MILLS	B
ROUTERS	C
SCORING/ENGRAVING COUNTERSINKS	D
TECHNICAL	E
INDEX	F

Blind Via

Tapered Blind Via Non-Undercut Drills

Diameter Range
0.10mm ~ 0.70mm

A
DRILLS



Micro and small sized tapered body drills designed for HDI applications promoting superior plating capability.

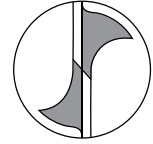
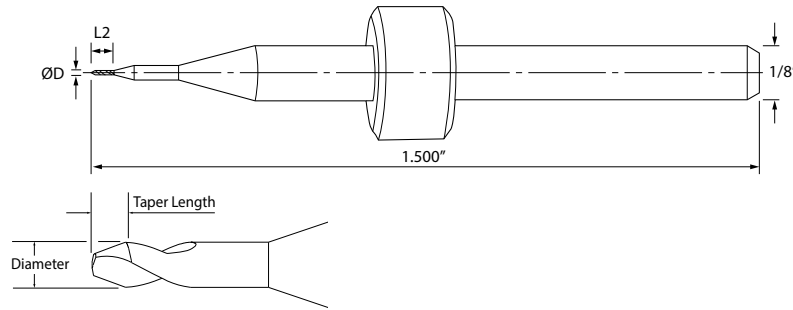

4 Facet Point Geometry



STANDARD Flute Length (Metric)

Part Number	Stock	Drill Size	Dimensions (mm)				Point Angle
			Cutting Diameter ØD	Tip Diameter	Taper Length	Flute Length	
						L2	
102.0039.030	●	0.10mm	0.100	0.041	0.08	0.40	175°
102.0050.030	●	0.13mm	0.130	0.053	0.10	0.50	175°
102.0059.030	●	0.15mm	0.150	0.064	0.12	0.60	175°
102.0079.050	●	0.20mm	0.200	0.084	0.16	0.80	175°
102.0098.050	●	0.25mm	0.250	0.104	0.20	1.00	175°
102.0118.075	●	0.30mm	0.300	0.104	0.27	1.20	175°
102.0138.075	●	0.35mm	0.350	0.104	0.27	1.20	175°
102.0157.075	●	0.40mm	0.400	0.137	0.36	1.60	175°
102.0177.100	●	0.45mm	0.450	0.122	0.45	1.35	175°
102.0197.100	●	0.50mm	0.500	0.137	0.50	1.50	175°
102.0217.100	●	0.55mm	0.550	0.150	0.55	1.65	175°
102.0236.100	●	0.60mm	0.600	0.163	0.60	1.80	175°
102.0256.100	●	0.65mm	0.650	0.178	0.65	1.95	175°
102.0276.125	●	0.70mm	0.700	0.191	0.70	2.10	175°

Part Numbers above include rings set at 0.800" - For Ringless Part Number, replace series "." with "-" (XXX-XXXX.XXXX)
Additional diameters and special ring colors available upon request.

For recommended cutting conditions please visit:
www.kyoceraprecisiontools.com/pcb/speeds-feeds

1-888-848-9266
OR

001-714-428-3611

Visit us online at KyoceraPrecisionTools.com

Large Inverse Diameter Non-Undercut Drills

Diameter Range
0.1285" ~ 0.2610"

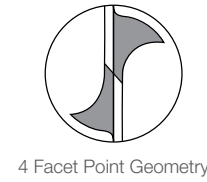
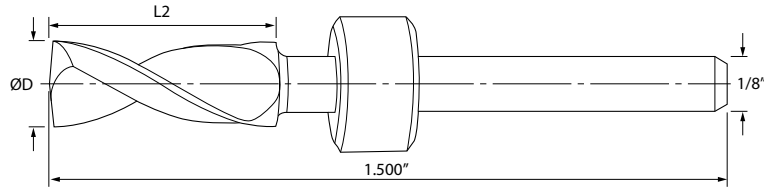

STANDARD Flute Length (Inch)

Part Number	Stock	Drill Size	Dimensions (in)		Point Angle
			Cutting Diameter	Flute Length	
			ØD	L2	
150.1285.500	●	#30	0.1285	0.4980	165°
150.1360.500	●	#29	0.1360	0.4980	165°
150.1405.500	●	#28	0.1405	0.4980	165°
150.1440.500	●	#27	0.1440	0.4980	165°
150.1520.500	●	#24	0.1520	0.4980	165°
150.1540.500	●	#23	0.1540	0.4980	165°
150.1562.500	●	5/32"	0.1562	0.4980	165°
150.1570.500	●	#22	0.1570	0.4980	165°
150.1610.500	●	#20	0.1610	0.4980	165°
150.1730.500	●	#17	0.1730	0.4980	165°
150.1800.500	●	#15	0.1800	0.4980	165°
150.1820.500	●	#14	0.1820	0.4980	165°
150.1850.500	●	#13-4.70mm	0.1850	0.4980	165°
150.1875.500	●	3/16"	0.1875	0.4980	165°
150.1890.500	●	#12-4.80mm	0.1890	0.4980	165°
150.1935.500	●	#10	0.1935	0.4980	165°
150.1990.500	●	#8	0.1990	0.4980	165°
150.2010.500	●	#7	0.2010	0.4980	165°
150.2040.500	●	#6	0.2040	0.4980	165°
150.2055.500	●	#5	0.2055	0.4980	165°
150.2090.500	●	#4	0.2090	0.4980	165°
150.2280.500	●	#1	0.2280	0.4980	165°
150.2340.500	●	A	0.2340	0.4980	165°
150.2380.500	●	B	0.2380	0.4980	165°
150.2500.500	●	1/4"-6.35mm	0.2500	0.4980	165°
150.2570.500	●	F	0.2570	0.4980	165°
150.2610.500	●	G	0.2610	0.4980	165°



Large sized drills with a reverse capable configuration of drilling small to large stacks.

DRILLS	A
END MILLS	B
ROUTERS	C
SCORING/ENGRAVING COUNTERSINKS	D
TECHNICAL	E
INDEX	F

Part Numbers above include rings set at 0.800" - For Ringless Part Number, replace series ".", with "-" (XXX-XXXX.XXXX)
Additional diameters and special ring colors available upon request.

For recommended cutting conditions please visit:
www.kyoceraprecisiontools.com/pcb/speeds-feeds

1-888-848-9266

OR

001-714-428-3611

Visit us online at KyoceraPrecisionTools.com

● : U.S. Standard Item

Large Inverse Diameter Non-Undercut Drills

Diameter Range
3.20mm ~ 4.25mm

A
DRILLS



Large sized drills with a reverse shank configuration capable of drilling small to large stacks.

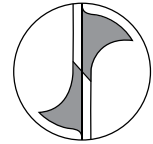
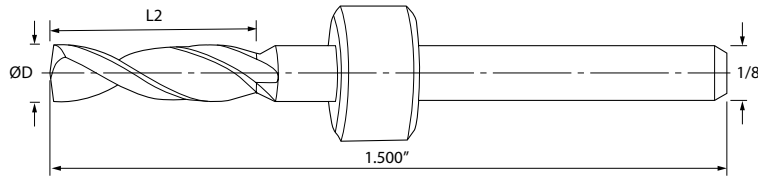

4 Facet Point Geometry



STANDARD Flute Length (Metric)

Part Number	Stock	Drill Size	Dimensions (mm)		Point Angle
			Cutting Diameter	Flute Length	
			ØD	L2	
150.1260.500	●	3.20mm	3.200	12.65	165°
150.1270.500	●	3.23mm	3.226	12.65	165°
150.1280.500	●	3.25mm	3.250	12.65	165°
150.1299.500	●	3.30mm	3.300	12.65	165°
150.1319.500	●	3.35mm	3.350	12.65	165°
150.1339.500	●	3.40mm	3.400	12.65	165°
150.1358.500	●	3.45mm	3.450	12.65	165°
150.1378.500	●	3.50mm	3.500	12.65	165°
150.1398.500	●	3.55mm	3.550	12.65	165°
150.1417.500	●	3.60mm	3.600	12.65	165°
150.1437.500	●	3.65mm	3.650	12.65	165°
150.1457.500	●	3.70mm	3.700	12.65	165°
150.1476.500	●	3.75mm	3.750	12.65	165°
150.1496.500	●	3.80mm	3.800	12.65	165°
150.1516.500	●	3.85mm	3.850	12.65	165°
150.1535.500	●	3.90mm	3.900	12.65	165°
150.1555.500	●	3.95mm	3.950	12.65	165°
150.1575.500	●	4.00mm	4.000	12.65	165°
150.1594.500	●	4.05mm	4.050	12.65	165°
150.1614.500	●	4.10mm	4.100	12.65	165°
150.1634.500	●	4.15mm	4.150	12.65	165°
150.1654.500	●	4.20mm	4.200	12.65	165°
150.1673.500	●	4.25mm	4.250	12.65	165°

Part Numbers above include rings set at 0.800" - For Ringless Part Number, replace series "." with "-" (XXX-XXXX.XXXX)
Additional diameters and special ring colors available upon request.

For recommended cutting conditions please visit:
www.kyoceraprecisiontools.com/pcb/speeds-feeds

1-888-848-9266
OR

001-714-428-3611

Visit us online at KyoceraPrecisionTools.com

Large Inverse Diameter Non-Undercut Drills

Diameter Range
4.30mm ~ 5.45mm

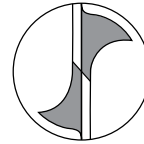
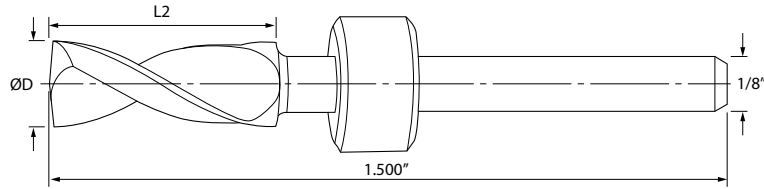

4 Facet Point Geometry



STANDARD Flute Length (Metric)

Part Number	Stock	Drill Size	Dimensions (mm)		Point Angle
			Cutting Diameter	Flute Length	
			ØD	L2	
150.1693.500	●	4.30mm	4.300	12.65	165°
150.1713.500	●	4.35mm	4.350	12.65	165°
150.1732.500	●	4.40mm	4.400	12.65	165°
150.1752.500	●	4.45mm	4.450	12.65	165°
150.1772.500	●	4.50mm	4.500	12.65	165°
150.1791.500	●	4.55mm	4.550	12.65	165°
150.1811.500	●	4.60mm	4.600	12.65	165°
150.1831.500	●	4.65mm	4.650	12.65	165°
150.1850.500	●	#13-4.70mm	4.700	12.65	165°
150.1870.500	●	4.75mm	4.750	12.65	165°
150.1890.500	●	#12-4.80mm	4.800	12.65	165°
150.1909.500	●	4.85mm	4.850	12.65	165°
150.1929.500	●	4.90mm	4.900	12.65	165°
150.1949.500	●	4.95mm	4.950	12.65	165°
150.1968.500	●	5.00mm	5.000	12.65	165°
150.1988.500	●	5.05mm	5.050	12.65	165°
150.2008.500	●	5.10mm	5.100	12.65	165°
150.2028.500	●	5.15mm	5.150	12.65	165°
150.2047.500	●	5.20mm	5.200	12.65	165°
150.2067.500	●	5.25mm	5.250	12.65	165°
150.2087.500	●	5.30mm	5.300	12.65	165°
150.2106.500	●	5.35mm	5.350	12.65	165°
150.2126.500	●	5.40mm	5.400	12.65	165°
150.2146.500	●	5.45mm	5.450	12.65	165°



Large sized drills with a reverse shank configuration capable of drilling small to large stacks.



Part Numbers above include rings set at 0.800" - For Ringless Part Number, replace series ".", with "-" (XXX-XXXX.XXXX) Additional diameters and special ring colors available upon request.



For recommended cutting conditions please visit: www.kyoceraprecisiontools.com/pcb/speeds-feeds

DRILLS	A
END MILLS	B
ROUTERS	C
SCORING/ENGRAVING COUNTERSINKS	D
TECHNICAL	E
INDEX	F

Large Inverse Diameter Non-Undercut Drills

Diameter Range
5.50mm ~ 6.70mm

A
DRILLS



Large sized drills with a reverse shank configuration capable of drilling small to large stacks.

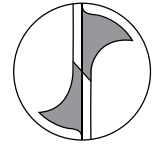
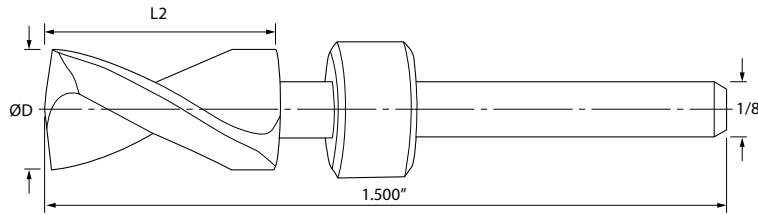

4 Facet Point Geometry



STANDARD Flute Length (Metric)

Part Number	Stock	Drill Size	Dimensions (mm)		Point Angle
			Cutting Diameter	Flute Length	
			ØD	L2	
150.2165.500	●	5.50mm	5.500	12.65	165°
150.2185.500	●	5.55mm	5.550	12.65	165°
150.2205.500	●	5.60mm	5.600	12.65	165°
150.2224.500	●	5.65mm	5.650	12.65	165°
150.2244.500	●	5.70mm	5.700	12.65	165°
150.2264.500	●	5.75mm	5.750	12.65	165°
150.2283.500	●	5.80mm	5.800	12.65	165°
150.2302.500	●	5.85mm	5.850	12.65	165°
150.2323.500	●	5.90mm	5.900	12.65	165°
150.2343.500	●	5.95mm	5.950	12.65	165°
150.2362.500	●	6.00mm	6.000	12.65	165°
150.2382.500	●	6.05mm	6.050	12.65	165°
150.2402.500	●	6.10mm	6.100	12.65	165°
150.2421.500	●	6.15mm	6.150	12.65	165°
150.2441.500	●	6.20mm	6.200	12.65	165°
150.2461.500	●	6.25mm	6.250	12.65	165°
150.2480.500	●	6.30mm	6.300	12.65	165°
150.2500.500	●	1/4"-6.35mm	6.350	12.65	165°
150.2520.500	●	6.40mm	6.400	12.65	165°
150.2559.500	●	6.50mm	6.500	12.65	165°
150.2579.500	●	6.55mm	6.550	12.65	165°
150.2598.500	●	6.60mm	6.600	12.649	165°
150.2618.500	●	6.65mm	6.650	12.649	165°
150.2638.500	●	6.70mm	6.700	12.649	165°

Part Numbers above include rings set at 0.800" - For Ringless Part Number, replace series "." with "-" (XXX-XXXX.XXXX)
Additional diameters and special ring colors available upon request.

For recommended cutting conditions please visit:
www.kyoceraprecisiontools.com/pcb/speeds-feeds

1-888-848-9266
OR

001-714-428-3611

Visit us online at KyoceraPrecisionTools.com

Flex Drill

Non-Undercut Drills

Diameter Range
0.0380"
0.15mm ~ 1.00mm

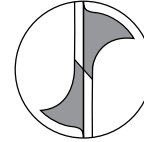
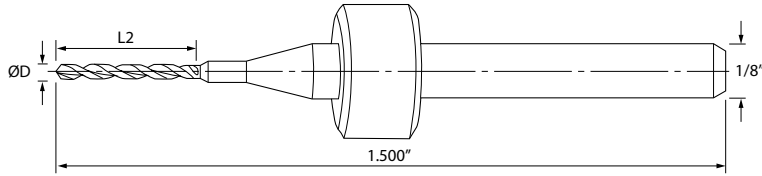

4 Facet Point Geometry



STANDARD Flute Length (Inch)

Part Number	Stock	Drill Size	Dimensions (in)		Point Angle
			Cutting Diameter	Flute Length	
			ØD	L2	
240.0380.197	●	#62	0.0380	0.197	130°



STANDARD Flute Length (Metric)

Part Number	Stock	Drill Size	Dimensions (mm)		Point Angle
			Cutting Diameter	Flute Length	
			ØD	L2	
240.0059.098	●	0.15mm	0.150	2.50	130°
240.0079.138	●	0.20mm	0.200	3.50	130°
240.0098.138	●	0.25mm	0.250	3.50	130°
240.0118.138	●	0.30mm	0.300	3.50	130°
240.0138.138	●	0.35mm	0.350	3.50	130°
240.0157.158	●	0.40mm	0.400	4.00	130°
240.0177.158	●	0.45mm	0.450	4.00	130°
240.0197.177	●	0.50mm	0.500	4.50	130°
240.0217.177	●	0.55mm	0.550	4.50	130°
240.0236.197	●	0.60mm	0.600	5.00	130°
240.0256.197	●	0.65mm	0.650	5.00	130°
240.0276.197	●	0.70mm	0.700	5.00	130°
240.0295.197	●	0.75mm	0.750	5.00	130°
240.0315.197	●	0.80mm	0.800	5.00	130°
240.0354.197	●	0.90mm	0.900	5.00	130°
240.0374.236	●	0.95mm	0.950	6.00	130°
240.0394.236	●	1.00mm	1.000	6.00	130°

Part Numbers above include rings set at 0.800" - For Ringless Part Number, replace series ".", with "-" (XXX-XXXX.XXXX)
 Additional diameters and special ring colors available upon request.

For recommended cutting conditions please visit:
www.kyoceraprecisiontools.com/pcb/speeds-feeds



Small and medium diameter, low thrust, open flute drills designed for drilling flexible printed circuits. Flex drills improve HWQ and reduce tears and debris deposition in soft materials.

DRILLS	A
END MILLS	B
ROUTERS	C
SCORING/ENGRAVING COUNTERSINKS	D
TECHNICAL	E
INDEX	F

Back Drill

Non-Undercut Drills

Diameter Range
0.0145" ~ 0.0420"
0.40mm ~ 1.00mm

A
 DRILLS

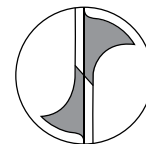
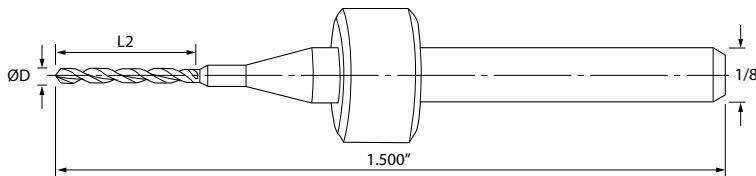

4 Facet Point Geometry



STANDARD Flute Length (Inch)

Part Number	Stock	Drill Size	Dimensions (in)		Point Angle
			Cutting Diameter	Flute Length	
			ØD	L2	
260.0145.197	●	#79	0.0145	0.1970	170°
260.0420.197	●	#58	0.0420	0.1968	170°



STANDARD Flute Length (Metric)

Part Number	Drill Size	Dimensions (mm)		Point Angle
		Cutting Diameter	Flute Length	
		ØD	L2	
260.0157.197	0.40mm	0.399	5.00	170°
260.0177.197	0.45mm	0.450	5.00	170°
260.0177.217	0.45mm	0.450	5.50	170°
260.0177.256	0.45mm	0.450	6.50	170°
260.0197.197	0.50mm	0.500	5.00	170°
260.0197.217	0.50mm	0.500	5.50	170°
260Q0197.256	0.50mm	0.500	6.50	170°
260.0217.197	0.55mm	0.550	5.00	170°
260.0236.197	0.60mm	0.600	5.00	170°
260.0256.197	0.65mm	0.650	5.00	170°
260.0276.197	0.70mm	0.701	5.00	170°
260.0276.256	0.70mm	0.701	6.50	170°
260.0295.197	0.75mm	0.749	5.00	170°
260.0315.197	0.80mm	0.800	5.00	170°
260.0335.197	0.85mm	0.851	5.00	170°
260.0354.197	0.90mm	0.899	5.00	170°
260.0394.197	1.00mm	1.000	5.00	170°

Small and medium sized drills designed for reduced cutting forces with exceptional chip flow resulting in superior hole wall quality. Flat point allows for precise Back Drilling processing.



Part Numbers above include rings set at 0.800" - For Ringless Part Number, replace series "." with "-" (XXX-XXXX.XXXX)
 Additional diameters and special ring colors available upon request.



For recommended cutting conditions please visit:
www.kyoceraprecisiontools.com/pcb/speeds-feeds

Short Flute Pilot Undercut Drills

Diameter Range
0.0228" ~ 0.0330"
0.10mm ~ 1.15mm

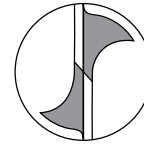
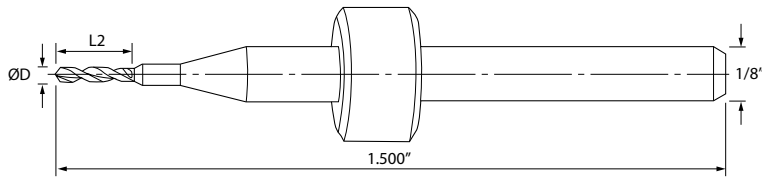

4 Facet Point Geometry



Short Flute Length (Inch)

Part Number	Stock	Drill Size	Dimensions (in)		Point Angle
			Cutting Diameter	Flute Length	
			ØD	L2	
405.0225.100	●	#74	0.0228	2.540	130°
405.0260.100	●	#71	0.0263	2.540	130°
405.0280.100	●	#70	0.0283	2.540	130°
405.0330.125	●	#66	0.0330	3.175	130°

Short Flute Length (Metric)



Part Number	Stock	Drill Size	Dimensions (mm)		Point Angle
			Cutting Diameter	Flute Length	
			ØD	L2	
405.0039.025	●	0.10mm	0.102	0.64	130°
405.0050.030	●	0.13mm	0.132	0.76	130°
405.0059.040	●	0.15mm	0.157	1.02	130°
405.0079.050	●	0.20mm	0.208	1.27	130°
405.0098.050	●	0.25mm	0.257	1.27	130°
405.0118.050	●	0.30mm	0.307	1.27	130°
405.0138.075	●	0.35mm	0.358	1.91	130°
405.0157.075	●	0.40mm	0.406	1.91	130°
405.0165.075	●	0.42mm	0.427	1.91	130°
405.0177.075	●	0.45mm	0.457	1.91	130°
405.0190.100	●	0.483mm	0.490	2.54	130°
405.0197.100	●	0.50mm	0.508	2.54	130°
405.0217.100	●	0.55mm	0.559	2.54	130°
405.0236.100	●	0.60mm	0.607	2.54	130°
405.0256.100	●	0.65mm	0.658	2.54	130°
405.0276.100	●	0.70mm	0.709	2.54	130°
405.0295.100	●	0.75mm	0.757	2.54	130°
405.0315.100	●	0.80mm	0.808	2.54	130°
405.0335.125	●	0.85mm	0.859	3.18	130°
405.0354.125	●	0.90mm	0.907	3.18	130°
405.0374.125	●	0.95mm	0.958	3.18	130°
405.0394.125	●	1.00mm	1.008	3.18	130°
405.0413.125	●	1.05mm	1.057	3.18	130°
405.0433.125	●	1.10mm	1.107	3.18	130°
405.0453.125	●	1.15mm	1.158	3.18	130°

Part Numbers above include rings set at 0.800" - For Ringless Part Number, replace series ".", with "-" (XXX-XXXX.XXXX)
 Additional diameters and special ring colors available upon request.

For recommended cutting conditions please visit:
www.kyoceraprecisiontools.com/pcb/speeds-feeds



Micro, small, and medium diameter undercut drills used in piloting holes exceeding 15:1 aspect ratio, promoting hole location precision.

DRILLS	A
END MILLS	B
ROUTERS	C
SCORING/ENGRAVING COUNTERSINKS	D
TECHNICAL	E
INDEX	F

Series 430

Hybrid Drill for PCB Industry



High Performance Drill with a Unique Hybrid Flute Design

High strength, and long endurance design

Superior hole wall quality

Ultra-precise drilled hole location

Can be used on a broad range of materials

Reliable, repeatable results



Series 430

New Hybrid Drill for PCB Industry

Kyocera Precision Tools (KPT) is committed to continuous improvement in all of its product offerings, particularly when faced with new PCB applications and materials. In order to meet these new challenges, KPT is pleased to introduce its new hybrid drill design, Series 430. The new design demonstrates high strength, longer endurance, precise drilled hole location, and superior hole wall quality. This document details the results of the work completed in the Kyocera Development Lab in order to demonstrate to the PCB market the new design's high performance.

Series 430 Drill Performance Study

Lab tests were conducted to ensure the product performed at a high level that is both reliable and repeatable.

Drill Hole Positional Accuracy / True Position Deviation (Internal Evaluation)

Centered Data	
Material :	High Tg
Thickness :	0.130"
Copper Content :	20 Layers
Hit Count :	1500

True Position Deviation			
Part Number	Mean	StdDev	Median
New : 430.0098.197	0.00092	0.00051	0.000840
Competitor A : 0.25mm/5mmFL	0.00109	0.00054	0.00104
p-value :	0.000		

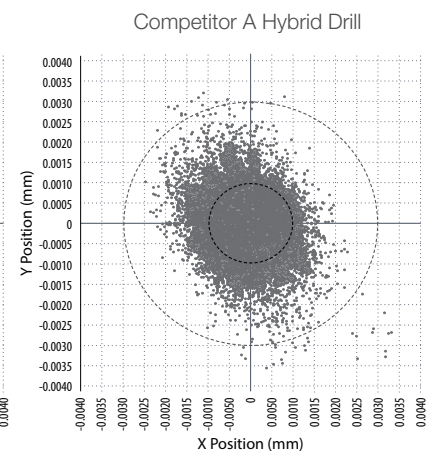
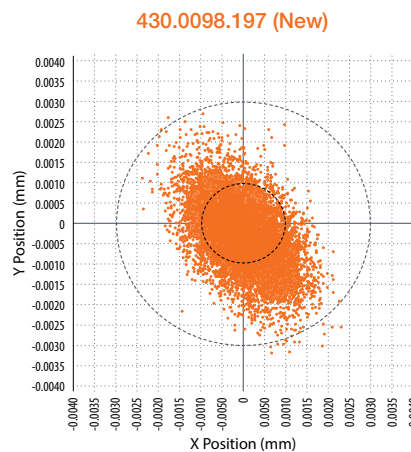

Robustness Tool Performance Comparison (Internal Evaluation)

Constant Variables	
Material :	High Tg
Thickness :	0.130"
Copper Content :	20 Layers

	Max infeed (ipm)
Series 430	275
Competitor A	248

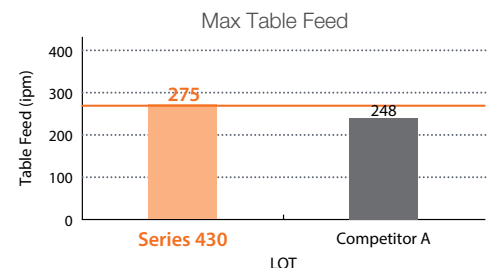

Feed: Start with 100 ipm, increment 20 ipm, stop at 400 ipm

Infeed at Breakage			
Part Number	Mean	StdDev	
New : 430.0098.197	275	26.4	
Competitor A : 0.25mm/5mmFL	248	21.9	
p-value :	0.002		

Tool Life Performance Comparison (Internal Evaluation)

Constant Variables	
Material :	High Tg
Thickness :	0.130"
Copper Content :	20 Layers

	Avg Hit/Breakage
Series 430	10,000
Competitor A	9,395

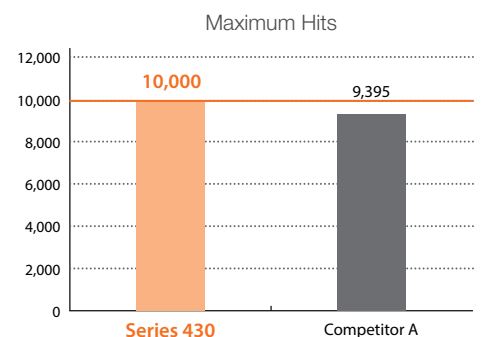

DRILLS	A
END MILLS	B
ROUTERS	C
SCORING/ENGRAVING COUNTERSINKS	D
TECHNICAL	E
INDEX	F

Hole Wall Quality at 1500 Hits (Internal Evaluation)

Constant Variables	
Material :	High Tg
Thickness :	0.140"
Copper Content :	18 Layers
Hit Count :	1500 Hits

A
DRILLS

Series 430													
Tool	Roughness (mil)					Avg Roughness	Nailheading						Avg Nailheading
	1	2	3	Avg	Max		1	2	3	Nominal	%Avg	%Max	
1	0.14	0.10	0.16	0.13	0.16	0.14	1.92	1.91	1.89	1.32	144%	145%	144%
2	0.16	0.12	0.17	0.15	0.17		1.88	1.92	1.90	1.32	144%	145%	
3	0.15	0.14	0.14	0.14	0.15		1.90	1.92	1.90	1.32	144%	146%	

Competitor A													
Tool	Roughness (mil)					Avg Roughness	Nailheading						Avg Nailheading
	1	2	3	Avg	Max		1	2	3	Nominal	%Avg	%Max	
1	0.22	0.25	0.23	0.23	0.25	0.21	1.95	1.91	1.95	1.32	147%	148%	146%
2	0.20	0.20	0.20	0.20	0.20		1.94	1.92	1.98	1.32	147%	150%	
3	0.18	0.19	0.20	0.19	0.20		1.95	1.90	1.89	1.32	145%	148%	

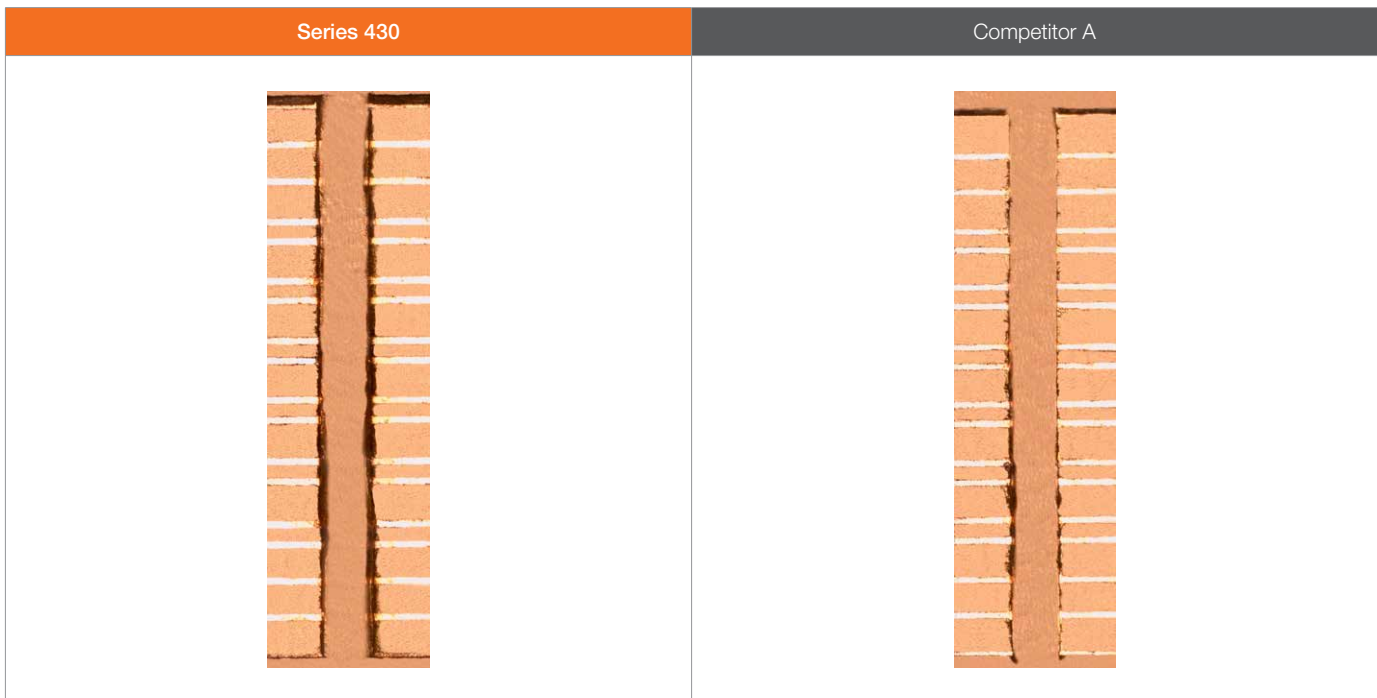

Two into One Flute Hybrid Undercut Drills

Diameter Range
0.0071" ~ 0.0145"

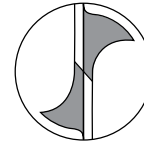
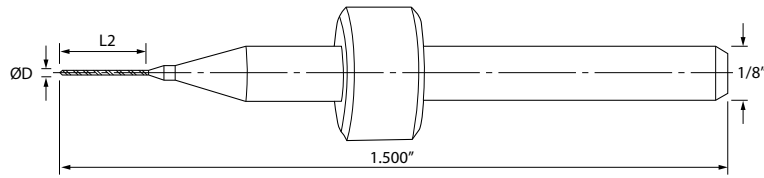

4 Facet Point Geometry



STANDARD Flute Length (Inch)

Part Number	Stock	Drill Size	Dimensions (in)		Point Angle
			Cutting Diameter	Flute Length	
			ØD	L2	
430.0071.138	●	#94	0.0071	0.1378	130°
430.0083.158	●	#91	0.0083	0.1575	130°
430.0091.197	●	#89	0.0091	0.1969	130°
430.0110.197	●	#85	0.0110	0.1969	130°
430.0125.236	●	#82	0.0125	0.2362	130°
430.0130.236	●	#81	0.0130	0.2362	130°
430.0145.236	●	#79	0.0145	0.2362	130°



Micro and small diameter drills designed with a unique hybrid flute advancing performance through superior strength, hole location precision, and tool life.

DRILLS	A
END MILLS	B
ROUTERS	C
SCORING/ENGRAVING COUNTERSINKS	D
TECHNICAL	E
INDEX	F



Part Numbers above include rings set at 0.800" - For Ringless Part Number, replace series ".#" with "-." (XXX-XXXX.XXXX) Additional diameters and special ring colors available upon request.



For recommended cutting conditions please visit:
www.kyoceraprecisiontools.com/pcb/speeds-feeds

1-888-848-9266

OR

001-714-428-3611

Visit us online at KyoceraPrecisionTools.com

● : U.S. Standard Item

Two into One Flute Hybrid Undercut Drills

Diameter Range
0.10mm ~ 1.00mm

A
DRILLS



Micro and small diameter drills designed with a unique hybrid flute advancing performance through superior strength, hole location precision, and tool life.

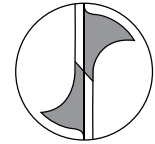
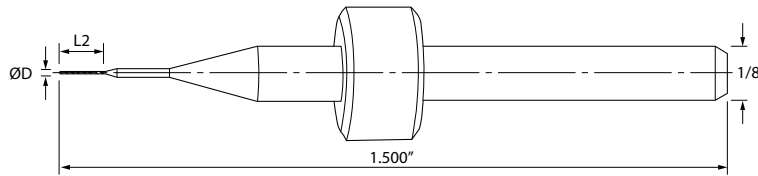

4 Facet Point Geometry



STANDARD Flute Length (Metric)

Part Number	Stock	Drill Size	Dimensions (mm)		Point Angle
			Cutting Diameter	Flute Length	
			ØD	L2	
430.0039.079	●	0.10mm	0.100	2.00	130°
430.0039.098	●	0.10mm	0.100	2.50	130°
430.0051.098	●	0.13mm	0.130	2.50	130°
430.0051.118	●	0.13mm	0.130	3.00	130°
430.0059.118	●	0.15mm	0.150	3.00	130°
430.0059.138	●	0.15mm	0.150	3.50	130°
430.0079.118	●	0.20mm	0.200	3.00	130°
430.0079.158	●	0.20mm	0.200	4.00	130°
430.0098.197	●	0.25mm	0.250	5.00	130°
430.0098.217	●	0.25mm	0.250	5.50	130°
430.0118.217	●	0.30mm	0.300	5.50	130°
430.0118.276	●	0.30mm	0.300	7.00	130°
430.0138.197	●	0.35mm	0.350	5.00	130°
430.0138.276	●	0.35mm	0.350	7.00	130°
430.0157.236	●	0.40mm	0.400	6.00	130°
430.0157.295	●	0.40mm	0.400	7.50	130°
430.0177.236	●	0.45mm	0.450	6.00	130°
430.0177.315	●	0.45mm	0.450	8.00	130°
430.0197.276	●	0.50mm	0.500	7.00	130°
430.0197.354	●	0.50mm	0.500	9.00	130°
430.0217.276	●	0.55mm	0.550	7.00	130°
430.0217.354	●	0.55mm	0.550	9.00	130°
430.0236.276	●	0.60mm	0.600	7.00	130°
430.0236.354	●	0.60mm	0.600	9.00	130°
430.0256.394	●	0.65mm	0.650	10.00	130°
430.0276.394	●	0.70mm	0.700	10.00	130°
430.0295.394	●	0.75mm	0.750	10.00	130°
430.0315.394	●	0.80mm	0.800	10.00	130°
430.0335.394	●	0.85mm	0.850	10.00	130°
430.0354.394	●	0.90mm	0.900	10.00	130°
430.0374.394	●	0.95mm	0.950	10.00	130°
430.0394.394	●	1.00mm	1.000	10.00	130°

Part Numbers above include rings set at 0.800" - For Ringless Part Number, replace series "." with "-" (XXX-XXXX.XXXX)
Additional diameters and special ring colors available upon request.

For recommended cutting conditions please visit:
www.kyoceraprecisiontools.com/pcb/speeds-feeds

1-888-848-9266
OR

001-714-428-3611

Visit us online at KyoceraPrecisionTools.com

Series 460 / 480

Advanced Undercut Drills



Designed for Superior Hole Wall Quality

Undercut diameter to reduce cutting friction and temperature

High helix for better debris flow

Thicker web for higher strength

Variable web taper for rigidity

Optimized flute volume to combat chip packing

Can be used on a broad range of materials



DRILLS	A
END MILLS	B
ROUTERS	C
SCORING/ENGRAVING COUNTERSINKS	D
TECHNICAL	E
INDEX	F

1 Increased Precision, Strength, and Tool Life

Precise Hole Location, High Strength, and Desirable Hole Wall Quality Characteristics

Robustness Tool Performance Comparison (Internal Evaluation)

A
DRILLS

Constant Variables	
Speed :	120,000 rpm
Retract :	800 ipm
Laminate :	0.062", 10 Layers
Stack Height :	2 High
Entry :	No Entry
Backup :	0.093"
No. of Hits:	100 Hits/ Tool/ Increment

	Max infeed (ipm)
Series 480	239
Competitor A	147

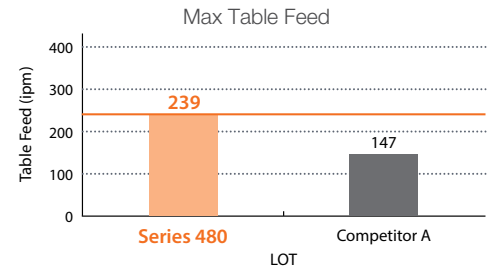

Feed: Start with 100 ipm, increment 20 ipm, stop at 400 ipm

Tool Life Performance Comparison (Internal Evaluation)

Constant Variables	
Speed :	120,000 rpm
Infeed :	80 ipm
Retract :	800 ipm
Laminate :	0.062", 10 Layers
Stack Height :	2 High
Entry :	No Entry
Backup :	0.093"
Max. Hits :	10,000

	Avg Hit/Breakage
Series 480	9,961
Competitor A	1,957

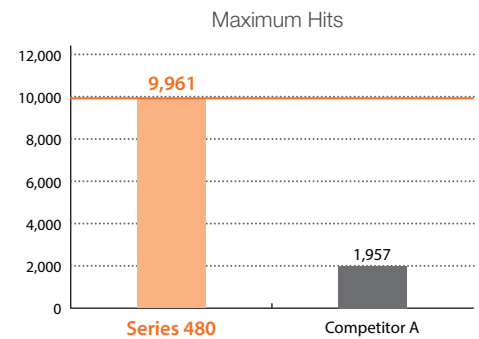

Drill Hole Positional Accuracy / True Position Deviation (Internal Evaluation)

Centered Data	
Max. Hits :	10,000
Layers :	10 Layers
Thickness :	0.062"
Stack Height :	2 High
Infeed Rate :	80 ipm
Speed :	120,000 rpm
Entry :	7 mil Solid Aluminum

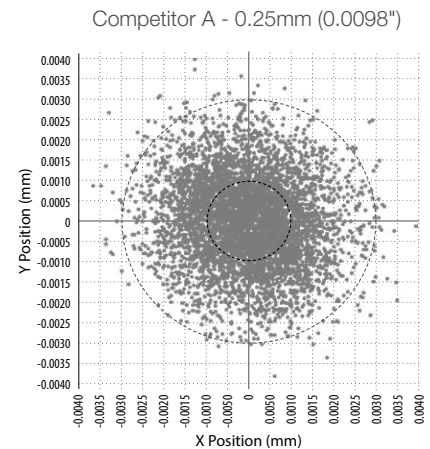
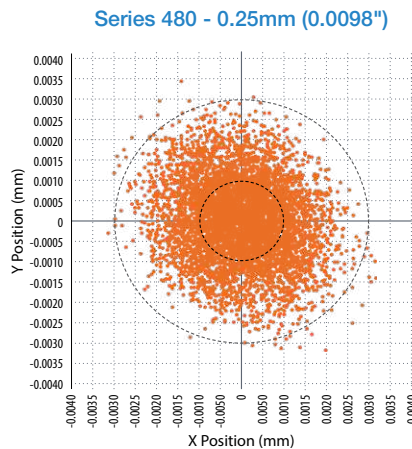

	Series 480	Competitor A
Cp :	1.72	1.37
CpK :	1.10	0.77
DTP :	0.0075	0.0201
Spec (+/-) :	0.003	0.003

2 Excellent Hole Wall Quality

Hole Wall Quality at 1500 Hits (Internal Evaluation)

Constant Variables	
Speed :	120,000 rpm
Infeed :	60 ipm
Retract :	800 ipm
Laminate :	0.062" Polyclad 370 HR, 10 Layers
Stack Height :	1 High
Entry :	7mil Solid Aluminum
Backup :	0.093", Tri Star Gold
Hit Count :	1500 Hits

Series 460 - 0.25mm (0.0098")													
Tool	Roughness (mil)					Avg Roughness	Nailheading						Avg Nailheading
	1	2	3	Avg	Max		1	2	3	Nominal	%Avg	%Max	
1	0.04	0.08	0.04	0.05	0.08	0.06	1.49	1.53	1.49	1.28	117%	120%	124%
2	0.04	0.06	0.04	0.05	0.06		1.63	1.56	1.53	1.28	123%	127%	
3	0.12	0.08	0.06	0.09	0.12		1.70	1.74	1.60	1.28	131%	136%	

Competitor A - 0.25mm (0.0098")													
Tool	Roughness (mil)					Avg Roughness	Nailheading						Avg Nailheading
	1	2	3	Avg	Max		1	2	3	Nominal	%Avg	%Max	
1	0.20	0.18	0.20	0.19	0.20	0.24	1.63	1.74	1.77	1.28	134%	138%	136%
2	0.26	0.32	0.22	0.27	0.32		1.77	1.74	1.70	1.28	136%	138%	
3	0.28	0.20	0.26	0.25	0.28		1.77	1.74	1.81	1.28	139%	141%	

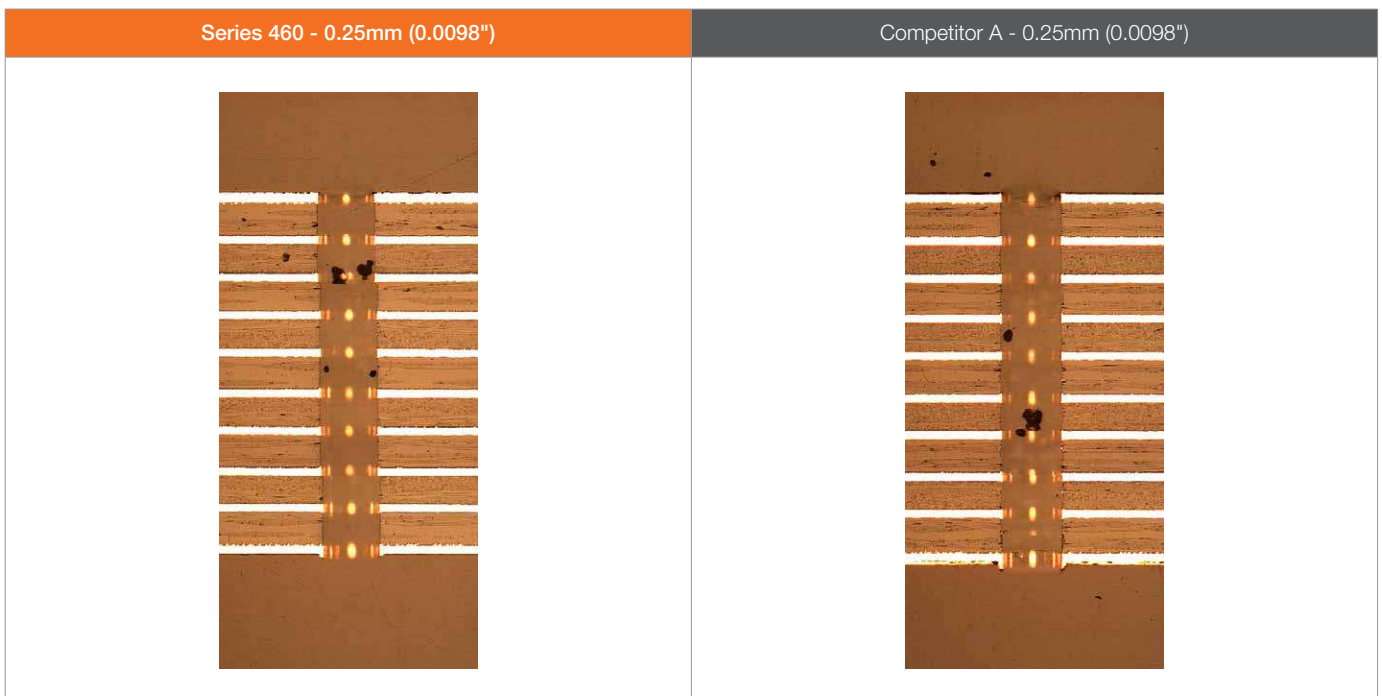

DRILLS	A
END MILLS	B
ROUTERS	C
SCORING/ENGRAVING COUNTERSINKS	D
TECHNICAL	E
INDEX	F

High Helix

Advanced Undercut Drills

Diameter Range
0.0091" ~ 0.0145"
0.15mm ~ 0.65mm

A
 DRILLS

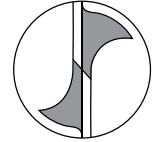
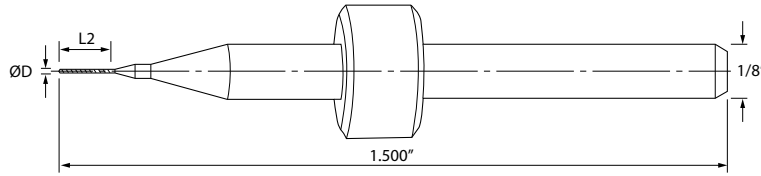

4 Facet Point Geometry



STANDARD Flute Length (Inch)

Part Number	Stock	Drill Size	Dimensions (in)		Point Angle
			Cutting Diameter	Flute Length	
			ØD	L2	
460.0091.158	●	#89	0.0091	0.1580	130°
460.0110.177	●	#85	0.0110	0.1770	130°
460.0130.217	●	#81	0.0130	0.2170	130°
460.0145.217	●	#79	0.0145	0.2170	130°

Micro, small, and medium sized undercut drills with standard flutes capable of drilling small to medium stacks.

STANDARD Flute Length (Metric)



Part Number	Stock	Drill Size	Dimensions (mm)		Point Angle
			Cutting Diameter	Flute Length	
			ØD	L2	
460.0059.079	●	0.15mm	0.150	2.01	130°
460.0079.118	●	0.20mm	0.200	3.00	130°
460.0098.177	●	0.25mm	0.250	4.50	130°
460.0118.217	●	0.30mm	0.300	5.51	130°
460.0118.236	●	0.30mm	0.300	5.99	130°
460.0138.217	●	0.35mm	0.351	5.51	130°
460.0157.217	●	0.40mm	0.400	5.51	130°
460.0177.220	●	0.45mm	0.450	5.59	130°
460.0197.220	●	0.50mm	0.500	5.59	130°
460.0217.250	●	0.55mm	0.550	6.35	130°
460.0256.250	●	0.65mm	0.650	6.35	130°

Part Numbers above include rings set at 0.800" - For Ringless Part Number, replace series "." with "-" (XXX-XXXX.XXXX)
 Additional diameters and special ring colors available upon request.

For recommended cutting conditions please visit:
www.kyoceraprecisiontools.com/pcb/speeds-feeds

High Helix

Advanced Undercut Drills

Diameter Range
0.0110" ~ 0.0520"

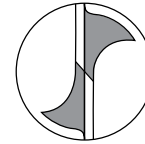
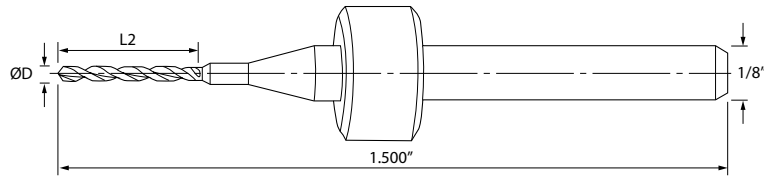

4 Facet Point Geometry



EXTENDED Flute Length (Inch)

Part Number	Stock	Drill Size	Dimensions (in)		Point Angle
			Cutting Diameter	Flute Length	
			ØD	L2	
480.0110.217	●	#85	0.0110	0.2170	130°
480.0135.280	●	#80	0.0135	0.2800	130°
480.0145.280	●	#79	0.0145	0.2800	130°
480.0210.310	●	#75	0.0210	0.3100	130°
480.0225.360	●	#74	0.0225	0.3600	130°
480.0250.340	●	#72	0.0250	0.3400	130°
480.0260.400	●	#71	0.0260	0.4000	130°
480.0280.400	●	#70	0.0280	0.3980	130°
480.0310.394	●	#68	0.0310	0.3940	130°
480.0320.394	●	#67	0.0320	0.3940	130°
480.0330.315	●	#66	0.0330	0.3130	130°
480.0360.400	●	#64	0.0360	0.3980	130°
480.0370.394	●	#63	0.0370	0.3940	130°
480.0380.400	●	#62	0.0380	0.3980	130°
480.0400.400	●	#60	0.0400	0.4000	130°
480.0420.400	●	#58	0.0420	0.4000	130°
480.0465.400	●	#56	0.0465	0.4000	130°
480.0520.400	●	#55	0.0520	0.4000	130°



Micro, small, and medium sized undercut drills with extended flutes capable of drilling medium to high stacks.

DRILLS	A
END MILLS	B
ROUTERS	C
SCORING/ENGRAVING COUNTERSINKS	D
TECHNICAL	E
INDEX	F



Part Numbers above include rings set at 0.800" - For Ringless Part Number, replace series "." with "-" (XXX-XXXX.XXXX) Additional diameters and special ring colors available upon request.



For recommended cutting conditions please visit: www.kyoceraprecisiontools.com/pcb/speeds-feeds

1-888-848-9266

OR

001-714-428-3611

Visit us online at KyoceraPrecisionTools.com

● : U.S. Standard Item

High Helix

Advanced Undercut Drills

Diameter Range
0.15mm ~ 1.65mm

A
DRILLS



Micro, small, and medium sized undercut drills with extended flutes capable of drilling medium to high stacks.

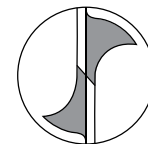
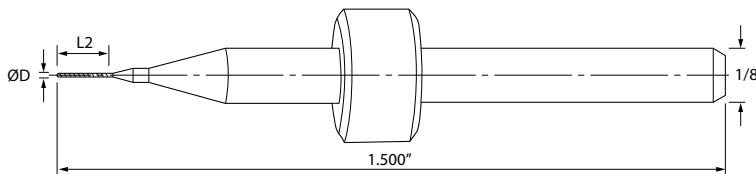

4 Facet Point Geometry



EXTENDED Flute Length (Metric)

Part Number	Stock	Drill Size	Dimensions (mm)		Point Angle
			Cutting Diameter	Flute Length	
			ØD	L2	
480.0059.118	●	0.15mm	0.150	3.00	130°
480.0079.158	●	0.20mm	0.200	4.01	130°
480.0098.217	●	0.25mm	0.250	5.51	130°
480.0118.256	●	0.30mm	0.300	6.50	130°
480.0138.277	●	0.35mm	0.350	7.04	130°
480.0157.295B1	●	0.40mm	0.400	7.49	130°
480.0177.295	●	0.45mm	0.450	7.49	130°
480.0197.310	●	0.50mm	0.500	7.87	130°
480.0217.340	●	0.55mm	0.550	8.64	130°
480.0236.340	●	0.60mm	0.600	8.64	130°
480.0256.340	●	0.65mm	0.650	8.64	130°
480.0276.360	●	0.70mm	0.700	9.04	130°
480.0295.360	●	0.75mm	0.750	9.14	130°
480.0315.400	●	0.80mm	0.800	10.16	130°
480.0335.400	●	0.85mm	0.850	10.11	130°
480.0354.400	●	0.90mm	0.900	10.11	130°
480.0374.400	●	0.95mm	0.950	10.11	130°
480.0394.400	●	1.00mm	1.000	10.11	130°
480.0413.400	●	1.05mm	1.050	10.11	130°
480.0433.400	●	1.10mm	1.100	10.11	130°
480.0441.400	●	1.12mm	1.120	10.11	130°
480.0453.400	●	1.15mm	1.150	10.11	130°
480.0472.400	●	1.20mm	1.200	10.11	130°
480.0492.400	●	1.25mm	1.250	10.11	130°
480.0512.394	●	1.30mm	1.300	10.01	130°
480.0531.394	●	1.35mm	1.350	10.01	130°
480.0551.394	●	1.40mm	1.400	10.01	130°
480.0571.394	●	1.45mm	1.450	10.01	130°
480.0591.394	●	1.50mm	1.500	10.01	130°
480.0610.394	●	1.55mm	1.550	10.01	130°
480.0630.394	●	1.60mm	1.600	10.01	130°

Part Numbers above include rings set at 0.800" - For Ringless Part Number, replace series "." with "-" (XXX-XXXX.XXXX)
Additional diameters and special ring colors available upon request.

For recommended cutting conditions please visit:
www.kyoceraprecisiontools.com/pcb/speeds-feeds

1-888-848-9266

OR

001-714-428-3611

Visit us online at KyoceraPrecisionTools.com

High Helix

Advanced Undercut Drills

Diameter Range
1.70mm ~ 3.15mm

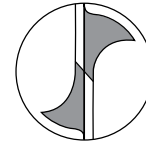
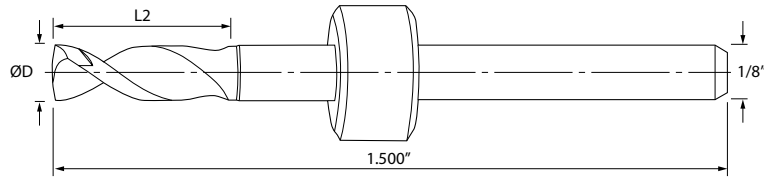

4 Facet Point Geometry



EXTENDED Flute Length (Metric)

Part Number	Stock	Drill Size	Dimensions (mm)		Point Angle
			Cutting Diameter	Flute Length	
			ØD	L2	
480.0650.394	●	1.65mm	1.650	10.01	130°
480.0669.394	●	1.70mm	1.700	10.01	130°
480.0689.394	●	1.75mm	1.750	10.01	130°
480.0709.394	●	1.80mm	1.800	10.01	130°
480.0728.394	●	1.85mm	1.850	10.01	130°
480.0748.394	●	1.90mm	1.900	10.01	130°
480.0768.394	●	1.95mm	1.950	10.01	130°
480.0787.394	●	2.00mm	2.000	10.01	130°
480.0807.394	●	2.05mm	2.050	10.01	130°
480.0827.394	●	2.10mm	2.100	10.01	130°
480.0846.394	●	2.15mm	2.150	10.01	130°
480.0866.394	●	2.20mm	2.200	10.01	130°
480.0886.394	●	2.25mm	2.250	10.01	130°
480.0906.394	●	2.30mm	2.300	10.01	130°
480.0925.394	●	2.35mm	2.350	10.01	130°
480.0945.394	●	2.40mm	2.400	10.01	130°
480.0965.394	●	2.45mm	2.450	10.01	130°
480.0984.394	●	2.50mm	2.500	10.01	130°
480.1004.394	●	2.55mm	2.550	10.01	165°
480.1024.394	●	2.60mm	2.600	10.01	165°
480.1043.394	●	2.65mm	2.650	10.01	165°
480.1063.394	●	2.70mm	2.700	10.01	165°
480.1083.394	●	2.75mm	2.750	10.01	165°
480.1102.394	●	2.80mm	2.800	10.01	165°
480.1122.394	●	2.85mm	2.850	10.01	165°
480.1142.394	●	2.90mm	2.900	10.01	165°
480.1161.394	●	2.95mm	2.950	10.01	165°
480.1181.394	●	3.00mm	3.000	10.01	165°
480.1201.394	●	3.05mm	3.050	10.01	165°
480.1220.394	●	3.10mm	3.100	10.01	165°
480.1240.394	●	3.15mm	3.150	10.01	165°



Micro, small, and medium sized undercut drills with extended flutes capable of drilling medium to high stacks.

DRILLS	A
END MILLS	B
ROUTERS	C
SCORING/ENGRAVING COUNTERSINKS	D
TECHNICAL	E
INDEX	F



Part Numbers above include rings set at 0.800" - For Ringless Part Number, replace series " ." with "-" (XXX-XXXX.XXXX)
Additional diameters and special ring colors available upon request.



For recommended cutting conditions please visit:
www.kyoceraprecisiontools.com/pcb/speeds-feeds

1-888-848-9266

OR

001-714-428-3611

Visit us online at KyoceraPrecisionTools.com

● : U.S. Standard Item

High Helix

Accuracy Oriented Advanced Non-Undercut Drills

Diameter Range
0.0040" ~ 0.0145"
0.20mm ~ 0.45mm

A
 DRILLS

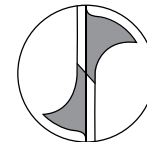
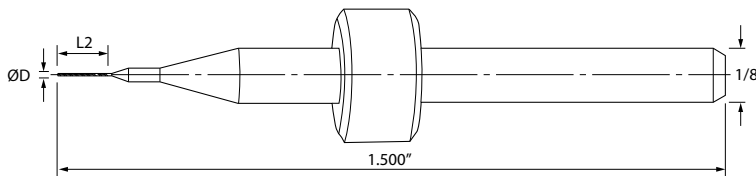

4 Facet Point Geometry



STANDARD Flute Length (Inch)

Part Number	Stock	Drill Size	Dimensions (in)		Point Angle
			Cutting Diameter	Flute Length	
			ØD	L2	
560.0040.040	●	0.0040"	0.0040	0.0400	130°
560.0091.150	●	#89	0.0091	0.1500	130°
560.0125.220	●	#82	0.0125	0.2200	130°
560.0130.220	●	#81	0.0130	0.2200	130°
560.0145.220	●	#79	0.0145	0.2200	130°

Micro and small sized drills with standard flutes capable of drilling small to medium stacks.

STANDARD Flute Length (Metric)



Part Number	Stock	Drill Size	Dimensions (mm)		Point Angle
			Cutting Diameter	Flute Length	
			ØD	L2	
560.0079.118	●	0.20mm	0.200	3.00	130°
560.0098.150	●	0.25mm	0.250	3.81	130°
560.0118.220	●	0.30mm	0.300	5.59	130°
560.0157.220	●	0.40mm	0.400	5.59	130°
560.0177.220	●	0.45mm	0.450	5.59	130°

Part Numbers above include rings set at 0.800" - For Ringless Part Number, replace series "." with "-" (XXX-XXXX.XXXX)
 Additional diameters and special ring colors available upon request.

For recommended cutting conditions please visit:
www.kyoceraprecisiontools.com/pcb/speeds-feeds

High Helix

Accuracy Oriented Advanced Non-Undercut Drills

Diameter Range
0.0071" ~ 0.0180"
0.10mm ~ 0.45mm

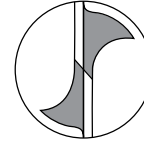
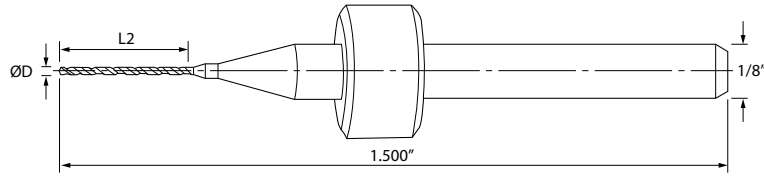

4 Facet Point Geometry



EXTENDED Flute Length (Inch)

Part Number	Stock	Drill Size	Dimensions (in)		Point Angle
			Cutting Diameter	Flute Length	
			ØD	L2	
580.0071.150	●	#94	0.0071	0.1500	130°
580.0105.220	●	#86	0.0105	0.2200	130°
580.0135.280	●	#80	0.0135	0.2800	130°
580.0145.280	●	#79	0.0145	0.2800	130°
580.0160.295	●	#78	0.0160	0.2950	130°
580.0180.295	●	#77	0.0180	0.2950	130°



EXTENDED Flute Length (Metric)

Part Number	Stock	Drill Size	Dimensions (mm)		Point Angle
			Cutting Diameter	Flute Length	
			ØD	L2	
580.0040.079	●	0.10mm	0.100	2.01	130°
580.0050.087	●	0.13mm	0.127	2.21	130°
580.0059.118	●	0.15mm	0.150	3.00	130°
580.0079.157	●	0.20mm	0.201	4.00	130°
580.0157.295	●	0.40mm	0.400	7.49	130°
580.0177.295	●	0.45mm	0.450	7.49	130°



Micro and small sized drills with extended flutes capable of drilling medium to high stacks.

DRILLS	A
END MILLS	B
ROUTERS	C
SCORING/ENGRAVING COUNTERSINKS	D
TECHNICAL	E
INDEX	F



Part Numbers above include rings set at 0.800" - For Ringless Part Number, replace series "." with "-" (XXX-XXXX.XXXX)
 Additional diameters and special ring colors available upon request.



For recommended cutting conditions please visit:
www.kyoceraprecisiontools.com/pcb/speeds-feeds

1-888-848-9266

OR

001-714-428-3611

Visit us online at KyoceraPrecisionTools.com

● : U.S. Standard Item

Reduced Deflection Slot

Non-Undercut Drills

Diameter Range
0.0160" ~ 0.0520"

A
DRILLS



Small and medium sized drills with standard flutes capable of slot drilling small to medium stacks.

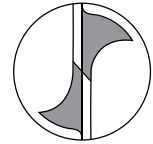
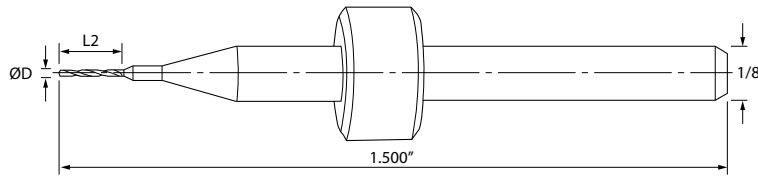

4 Facet Point Geometry



STANDARD Flute Length (Inch)

Part Number	Stock	Drill Size	Dimensions (in)		Point Angle
			Cutting Diameter	Flute Length	
			ØD	L2	
700.0160.100	●	#78	0.0160	0.0980	150°
700.0180.100	●	#77	0.0180	0.0980	150°
700.0200.150	●	#76	0.0200	0.1480	150°
700.0225.280	●	#74	0.0225	0.2860	150°
700.0240.280	●	#73	0.0240	0.2860	150°
700.0250.280	●	#72	0.0250	0.2860	150°
700.0260.280	●	#71	0.0260	0.2860	150°
700.0280.280	●	#70	0.0280	0.2880	150°
700.0310.280	●	#68	0.0310	0.2880	150°
700.0320.280	●	#67	0.0320	0.2880	150°
700.0330.280	●	#66	0.0330	0.2890	150°
700.0360.280	●	#64	0.0360	0.2890	150°
700.0370.280	●	#63	0.0370	0.2900	150°
700.0430.280	●	#57	0.0430	0.2910	150°
700.0520.280	●	#55	0.0520	0.2930	150°

 Part Numbers above include rings set at 0.800" - For Ringless Part Number, replace series "." with "-" (XXX-XXXX.XXXX)
Additional diameters and special ring colors available upon request.

 For recommended cutting conditions please visit:
www.kyoceraprecisiontools.com/pcb/speeds-feeds

1-888-848-9266
OR

001-714-428-3611

Visit us online at KyoceraPrecisionTools.com

Reduced Deflection Slot Non-Undercut Drills

Diameter Range
0.55mm ~ 1.15mm

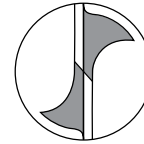
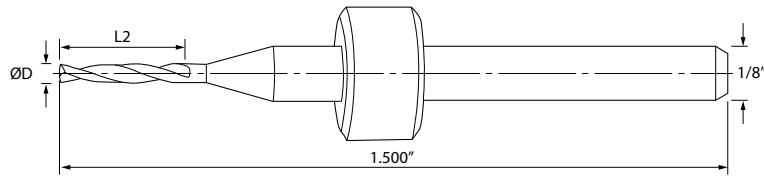

4 Facet Point Geometry



STANDARD Flute Length (Metric)

Part Number	Stock	Drill Size	Dimensions (mm)		Point Angle
			Cutting Diameter	Flute Length	
			ØD	L2	
700.0217.280	●	0.55mm	0.551	7.26	150°
700.0236.280	●	0.60mm	0.600	7.26	150°
700.0256.280	●	0.65mm	0.650	7.26	150°
700.0276.280	●	0.70mm	0.700	7.29	150°
700.0295.280	●	0.75mm	0.750	7.32	150°
700.0315.280	●	0.80mm	0.800	7.32	150°
700.0335.280	●	0.80mm	0.850	7.34	150°
700.0354.280	●	0.80mm	0.900	7.34	150°
700.0433.280	●	0.80mm	1.100	7.39	150°
700.0453.280	●	0.80mm	1.151	7.39	150°



Small and medium sized drills with standard flutes capable of slot drilling small to medium stacks.

DRILLS	A
END MILLS	B
ROUTERS	C
SCORING/ENGRAVING COUNTERSINKS	D
TECHNICAL	E
INDEX	F



Part Numbers above include rings set at 0.800" - For Ringless Part Number, replace series "." with "-" (XXX-XXXX.XXXX)
Additional diameters and special ring colors available upon request.



For recommended cutting conditions please visit:
www.kyoceraprecisiontools.com/pcb/speeds-feeds

Reduced Deflection Slot

Extended Flute Non-Undercut Drills

Diameter Range
0.0420" ~ 0.0465"

A
DRILLS



Small and medium sized drills with extended flutes capable of slot drilling medium to high stacks.

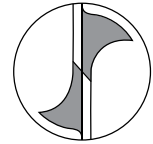
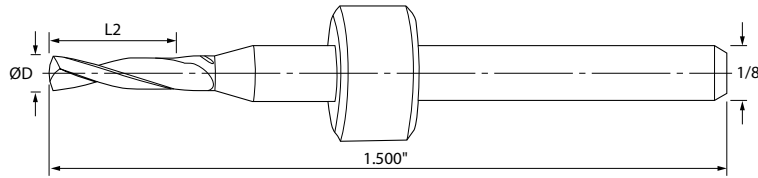

4 Facet Point Geometry

EXTENDED Flute Length (Inch)



Part Number	Stock	Drill Size	Dimensions (in)		Point Angle
			Cutting Diameter	Flute Length	
			ØD	L2	
750.0420.340	●	#58	0.0420	0.3540	150°
750.0465.340	●	#56	0.0465	0.3500	150°



Part Numbers above include rings set at 0.800" - For Ringless Part Number, replace series "." with "-" (XXX-XXXX.XXXX)
Additional diameters and special ring colors available upon request.



For recommended cutting conditions please visit:
www.kyoceraprecisiontools.com/pcb/speeds-feeds

Reduced Deflection Slot

Extended Flute Non-Undercut Drills

Diameter Range
0.95mm ~ 2.00mm

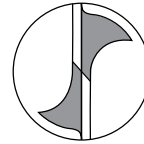
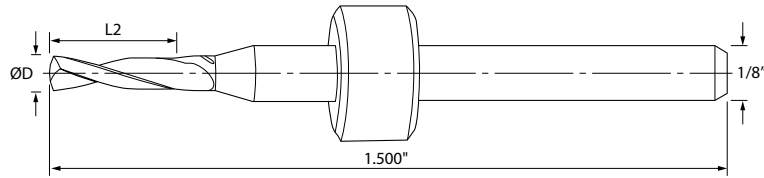

4 Facet Point Geometry



EXTENDED Flute Length (Metric)

Part Number	Stock	Drill Size	Dimensions (mm)		Point Angle
			Cutting Diameter	Flute Length	
			ØD	L2	
750.0374.340	●	0.95mm	0.950	8.89	150°
750.0394.340	●	1.00mm	1.001	8.89	150°
750.0413.340	●	1.05mm	1.049	8.89	150°
750.0433.340	●	1.10mm	1.100	8.99	150°
750.0453.340	●	1.15mm	1.151	8.81	150°
750.0472.340	●	1.20mm	1.199	8.89	150°
750.0492.340	●	1.25mm	1.250	8.94	150°
750.0512.340	●	1.30mm	1.300	8.89	150°
750.0531.340	●	1.35mm	1.349	8.97	150°
750.0551.340	●	1.40mm	1.400	8.99	150°
750.0571.340	●	1.45mm	1.450	9.02	150°
750.0591.340	●	1.50mm	1.501	9.02	150°
750.0610.340	●	1.55mm	1.549	9.02	150°
750.0630.340	●	1.60mm	1.600	8.89	150°
750.0650.340	●	1.65mm	1.651	9.02	150°
750.0669.340	●	1.70mm	1.699	9.02	150°
750.0689.340	●	1.75mm	1.750	9.02	150°
750.0709.340	●	1.80mm	1.801	8.64	150°
750.0728.340	●	1.85mm	1.849	8.64	150°
750.0748.340	●	1.90mm	1.900	9.02	150°
750.0768.340	●	1.95mm	1.951	8.59	150°
750.0787.340	●	2.00mm	1.999	9.02	150°



Small and medium sized drills with extended flutes capable of slot drilling medium to high stacks.

DRILLS	A
END MILLS	B
ROUTERS	C
SCORING/ENGRAVING COUNTERSINKS	D
TECHNICAL	E
INDEX	F



Part Numbers above include rings set at 0.800" - For Ringless Part Number, replace series "." with "-" (XXX-XXXX.XXXX)
Additional diameters and special ring colors available upon request.



For recommended cutting conditions please visit:
www.kyoceraprecisiontools.com/pcb/speeds-feeds

1-888-848-9266

OR

001-714-428-3611

Visit us online at KyoceraPrecisionTools.com

● : U.S. Standard Item

END MILLS

B

B1 - B12

End Mills	B1 - B12
Series 1500 - One Flute End Mills for Soft Materials	B2
Series 1560 - One Flute End Mills for Flexible Laminates	B3
Series 1600 - Two Flute End Mills	B4
Series 1603 - Two Flute Flat Point Square End Mills	B6
Series 1660 - Two Flute End Mills for Flexible Laminates	B7
Series 1730 - Three Flute Zero Helix No End style (Safe End) End Mills	B8
Series 1735 - Three Flute End Mills for Clean Edges	B9
Series 1800 - Four Flute End Mills	B12

Single Flute

Flexible Laminates End Mills

Diameter Range
0.0312" ~ 0.1250"
1.27mm ~ 2.00mm

B
 END MILLS



Single flute end mill designed for routing or milling printed circuit boards, plexiglass, soft materials, or soft metals.

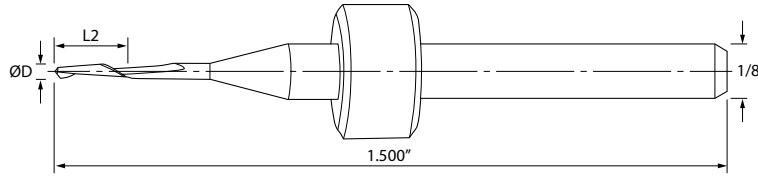

STANDARD Flute Length (Inch)



Part Number	Stock	End Mill Size	Dimensions (in)		Helix Angle	End Style
			Cutting Diameter	Flute Length		
			ØD	L2		
1500.0312.150D	●	1/32"	0.0312	0.1500	30°	Drill Point
1500.0625.200D	●	1/16"	0.0625	0.2000	30°	Drill Point
1500.0625.200	●	1/16"	0.0625	0.2000	26°	Square
1500.0625.200F1	●	1/16"	0.0625	0.2000	26°	Dish
1500.0625.250	●	1/16"	0.0625	0.2500	30°	Square
1500.0938.375	●	3/32"	0.0938	0.3700	33°	Square
1500.1250.400	●	1/8"	0.1250	0.4000	30°	Drill Point

STANDARD Flute Length (Metric)



Part Number	Stock	End Mill Size	Dimensions (mm)		Helix Angle	End Style
			Cutting Diameter	Flute Length		
			ØD	L2		
1500.0500.197	●	1.27	1.270	0.500	30°	Square
1500.0787.315	●	2.00	2.000	0.800	28°	Square

Part Numbers above include rings set at 0.800" - For Ringless Part Number, replace series "." with "-" (XXX-XXXX.XXXX)
 Additional diameters and special ring colors available upon request.

For recommended cutting conditions please visit:
www.kyoceraprecisiontools.com/pcb/speeds-feeds

Single Flute

Flexible Laminates End Mills

Diameter Range
0.55mm ~ 2.00mm

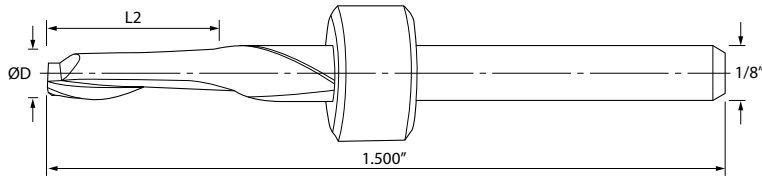

STANDARD Flute Length (Metric)



Part Number	Stock	End Mill Size	Dimensions (mm)		Helix Angle
			Cutting Diameter	Flute Length	
			ØD	L2	
1560.0217.138	●	0.55mm	0.550	3.50	30°
1560.0315.094	●	0.80mm	0.800	2.39	30°
1560.0394.118	●	1.00mm	1.000	3.00	30°
1560.0453.157	●	1.15mm	1.150	4.00	30°
1560.0472.142	●	1.20mm	1.200	3.61	30°
1560.0630.189	●	1.60mm	1.600	4.80	30°
1560.0787.236	●	2.00mm	2.000	6.00	30°



Single flute end mill designed for routing or milling flexible printed circuit boards, plexiglass, or soft materials.

DRILLS	A
END MILLS	B
ROUTERS	C
SCORING/ENGRAVING COUNTERSINKS	D
TECHNICAL	E
INDEX	F



Part Numbers above include rings set at 0.800" - For Ringless Part Number, replace series "." with "-" (XXX-XXXX.XXXX)
Additional diameters and special ring colors available upon request.



For recommended cutting conditions please visit:
www.kyoceraprecisiontools.com/pcb/speeds-feeds

Two Flute Square End Mills

Diameter Range
0.0312" ~ 0.1250"

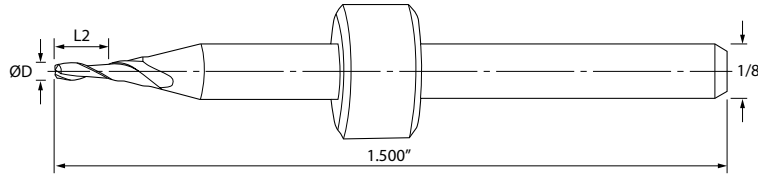

B
END MILLS

STANDARD Flute Length (Inch)



Part Number	Stock	End Mill Size	Dimensions (in)		Helix Angle
			Cutting Diameter	Flute Length	
			ØD	L2	
1600.0312.120	●	1/32"	0.0312	0.1200	30°
1600.0500.200	●	0.0500"	0.0500	0.2000	30°
1600.0625.250	●	1/16"	0.0625	0.2500	30°
1600.0938.390	●	3/32"	0.0938	0.3900	30°
1600.1250.500	●	1/8"	0.1250	0.5000	30°

Two flute end mill designed for routing or milling printed circuit boards, plexiglass, soft materials, or soft metals.

 Part Numbers above include rings set at 0.800" - For Ringless Part Number, replace series "." with "-" (XXX-XXXX.XXXX)
Additional diameters and special ring colors available upon request.

 For recommended cutting conditions please visit:
www.kyoceraprecisiontools.com/pcb/speeds-feeds

Two Flute Square End Mills

Diameter Range
0.30mm ~ 3.00mm

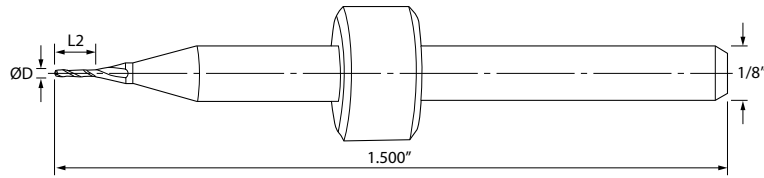

STANDARD Flute Length (Metric)



Part Number	Stock	End Mill Size	Dimensions (mm)		Helix Angle
			Cutting Diameter	Flute Length	
			ØD	L2	
1600.0118.045	●	0.30mm	0.300	1.14	30°
1600.0150.050	●	0.38mm	0.380	1.27	30°
1600.0157.079	●	0.40mm	0.400	2.00	30°
1600.0177.079	●	0.45mm	0.450	2.00	30°
1600.0197.079	●	0.50mm	0.500	2.00	30°
1600.0197.118	●	0.50mm	0.500	3.00	30°
1600.0217.065	●	0.55mm	0.550	1.65	30°
1600.0236.079	●	0.60mm	0.600	2.00	30°
1600.0276.120	●	0.70mm	0.700	3.05	30°
1600.0315.120	●	0.80mm	0.800	3.05	30°
1600.0315.157	●	0.80mm	0.800	4.00	30°
1600.0354.120	●	0.90mm	0.900	3.05	30°
1600.0394.120	●	1.00mm	1.000	3.05	30°
1600.0394.200	●	1.00mm	1.000	5.08	30°
1600.0472.138	●	1.20mm	1.200	3.50	30°
1600.0472.210	●	1.20mm	1.200	5.33	30°
1600.0551.195	●	1.40mm	1.400	4.95	30°
1600.0591.250	●	1.50mm	1.500	6.35	30°
1600.0630.188	●	1.60mm	1.600	4.78	30°
1600.0630.250	●	1.60mm	1.600	6.35	30°
1600.0630.315	●	1.60mm	1.600	8.00	30°
1600.0787.340	●	2.00mm	2.000	8.64	30°
1600.0945.390	●	2.40mm	2.400	9.91	30°
1600.1181.500	●	3.00mm	3.000	12.70	30°



Two flute end mill designed for routing or milling printed circuit boards, plexiglass, soft materials, or soft metals.

DRILLS	A
END MILLS	B
ROUTERS	C
SCORING/ENGRAVING COUNTERSINKS	D
TECHNICAL	E
INDEX	F



Part Numbers above include rings set at 0.800" - For Ringless Part Number, replace series ".", with "-" (XXX-XXXX.XXXX) Additional diameters and special ring colors available upon request.



For recommended cutting conditions please visit: www.kyoceraprecisiontools.com/pcb/speeds-feeds

Two Flute

Flat Point Square End Mills

Diameter Range
0.0625" ~ 0.1250"
1.20mm

B
 END MILLS

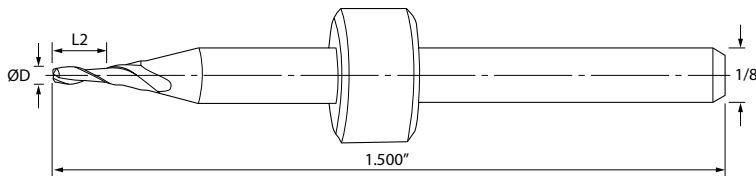

STANDARD Flute Length (Inch)



Part Number	Stock	End Mill Size	Dimensions (in)		Helix Angle	Ring Color
			Cutting Diameter	Flute Length		
			ØD	L2		
1603Q0625.250	●	1/16"	0.0625	0.250	30	Red
1603Q0938.390	●	3/32"	0.0938	0.390	30	Black
1603Q1250.500	●	1/8"	0.1250	0.500	30	Black

STANDARD Flute Length (Metric)



Part Number	Stock	End Mill Size	Dimensions (in)		Helix Angle	Ring Color
			Cutting Diameter	Flute Length		
			ØD	L2		
1603Q0472.210	●	1.20mm	.0472"	.210"	30	Black

Two flute flat point end mill designed for routing or milling printed circuit boards, plexiglass, soft materials, or soft metals.

Part Numbers above include rings set at 0.800" - For Ringless Part Number, replace series "." with "-" (XXX-XXXX.XXXX)
 Additional diameters and special ring colors available upon request.

For recommended cutting conditions please visit:
www.kyoceraprecisiontools.com/pcb/speeds-feeds

Two Flute

Square Flexible Laminates End Mills

Diameter Range
0.80mm

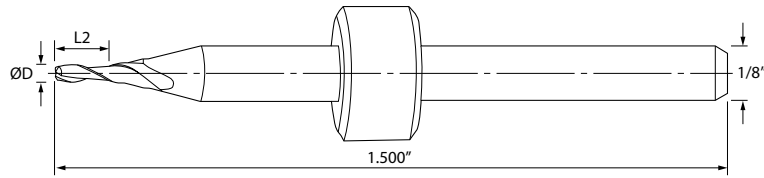

STANDARD Flute Length (Metric)



Part Number	Stock	End Mill Size	Dimensions (mm)		Helix Angle
			Cutting Diameter	Flute Length	
			ØD	L2	
1660.0315.093	●	0.80mm	0.800	2.36	30°
1660.0630.295	●	1.60mm	1.600	7.50	16°



Two flute end mill designed for routing or milling flexible printed circuit boards, plexiglass, or soft materials.

DRILLS	A
END MILLS	B
ROUTERS	C
SCORING/ENGRAVING COUNTERSINKS	D
TECHNICAL	E
INDEX	F

 Part Numbers above include rings set at 0.800" - For Ringless Part Number, replace series "." with "-" (XXX-XXXX.XXXX)
Additional diameters and special ring colors available upon request.

 For recommended cutting conditions please visit:
www.kyoceraprecisiontools.com/pcb/speeds-feeds

Three Flute

Zero Helix End Mills

Diameter Range
0.80mm ~ 2.40mm

B
END MILLS

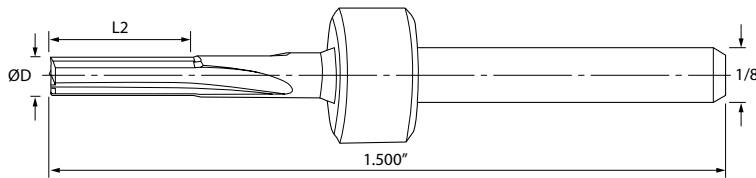

STANDARD Flute Length (Metric)

Part Number	Stock	End Mill Size	Dimensions (mm)		Helix Angle
			Cutting Diameter	Flute Length	
			ØD	L2	
1730.0315.120	●	0.80mm	0.800	3.05	0°
1730.0630.315	●	1.60mm	1.600	8.00	0°
1730.0787.320	●	2.00mm	2.000	8.13	0°
1730.0945.394	●	2.40mm	2.400	10.00	0°

Three flute zero helix cutter designed for side routing printed circuit boards, gold tab connectors, soft materials, or soft metals.

Part Numbers above include rings set at 0.800" - For Ringless Part Number, replace series "." with "-" (XXX-XXXX.XXXX)
Additional diameters and special ring colors available upon request.

For recommended cutting conditions please visit:
www.kyoceraprecisiontools.com/pcb/speeds-feeds

Series 1735

Soft Laminate and
Fine Metal Edge End Mill

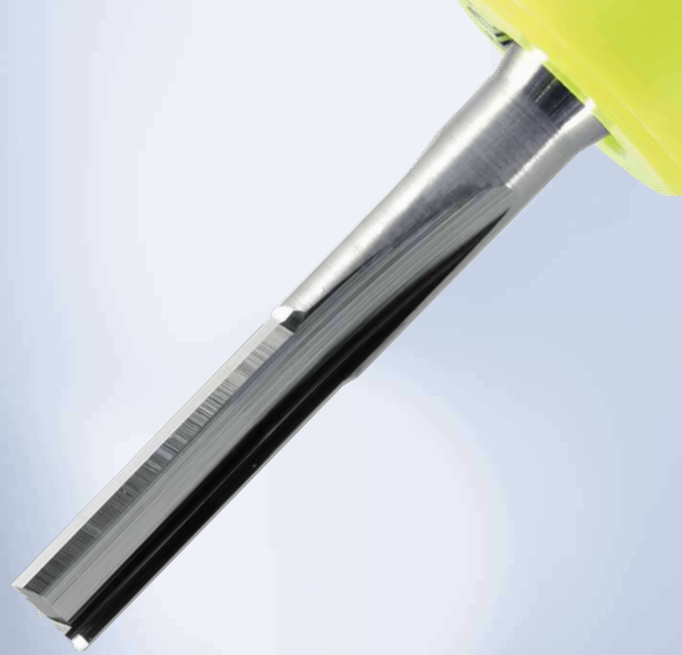

Designed for Ultra-fine Edge Finish

When flawless edges are required

Great for soft PCB laminate materials and metals

Capable of surface milling and plunging

Smooth edges and cleanly cut fibers

Does not require use of entry material



Series 1735

Soft Laminate and Fine Metal Edge End Mill

Series 1735 End Mills designed to provide an ultra-fine edge finish on soft PCB laminate materials and metals that require flawless edges. End Style allows surface milling and plunging.

Flex products, Aramid reinforced materials, PTFE, most soft materials, and gold fingers are prime examples of the challenges posed to PCB Fabrication Departments worldwide. In some cases, parameters can be adjusted with standard tools to address the rough edges, raised burrs, and/or fibers. There are, however, cases that require special tools and methods. Specific to these cases, Kyocera Precision Tools introduces an upgrade to the 1730 design with surface milling and plunging capabilities.

In addition, these tools generally eliminate the requirement of entry material that is sometimes needed on this type of work when using conventional cutters.

** This product requires specific processes and operating parameters.
For optimal results, please contact a Kyocera Precision Tools field engineer.*

Material: PTFE

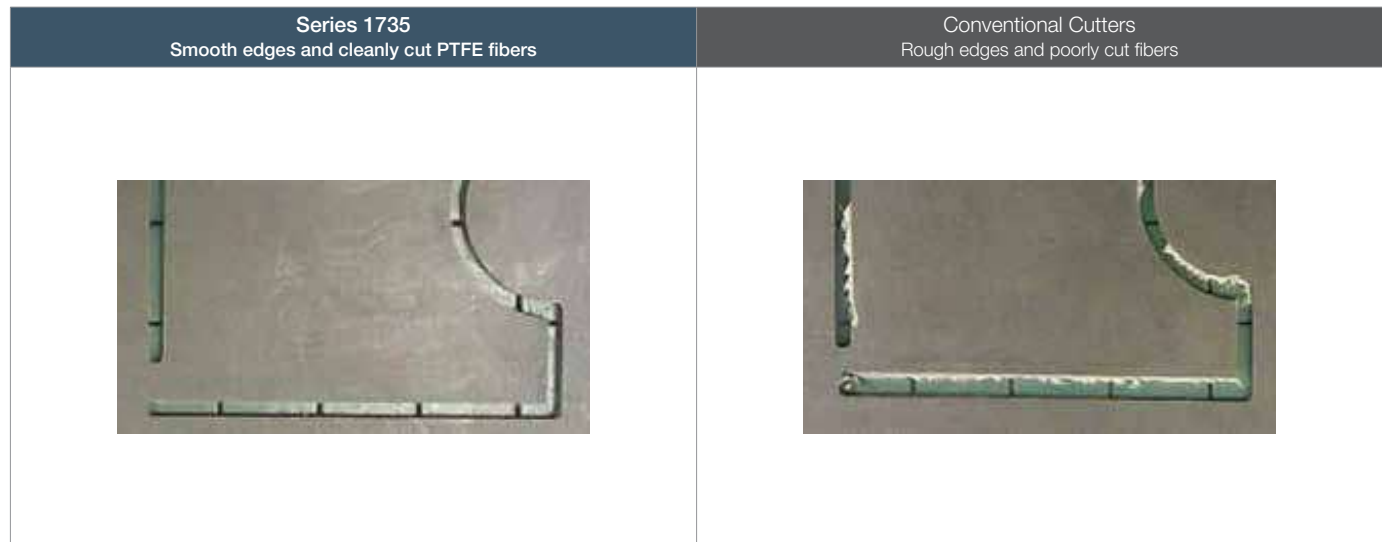

Material: Gold Tabs/Connectors



Three Flute

Square Flexible Laminates End Mills

Diameter Range
0.1250"
0.80mm ~ 2.40mm

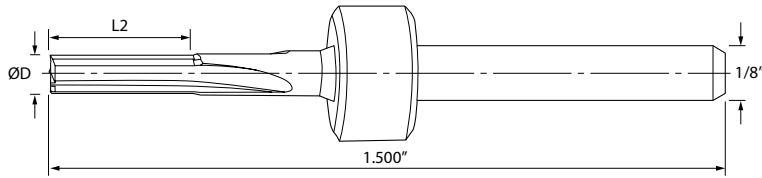

STANDARD Flute Length (Inch)



Part Number	Stock	End Mill Size	Dimensions (in)		Helix Angle
			Cutting Diameter	Flute Length	
			ØD	L2	
1735.1250.500	●	0.1250"	0.1250	0.5000	0°

STANDARD Flute Length (Metric)



Part Number	Stock	End Mill Size	Dimensions (mm)		Helix Angle
			Cutting Diameter	Flute Length	
			ØD	L2	
1735.0315.138	●	0.80mm	0.800	3.50	0°
1735.0630.315	●	1.60mm	1.600	8.00	0°
1735.0945.315	●	2.40mm	2.400	8.00	0°



Three flute zero helix end mill designed for side routing or milling printed circuit boards, gold tab connectors, soft materials, or soft metals.

DRILLS	A
END MILLS	B
ROUTERS	C
SCORING/ENGRAVING COUNTERSINKS	D
TECHNICAL	E
INDEX	F



Part Numbers above include rings set at 0.800" - For Ringless Part Number, replace series "." with "-" (XXX-XXXX.XXXX)
 Additional diameters and special ring colors available upon request.



For recommended cutting conditions please visit:
www.kyoceraprecisiontools.com/pcb/speeds-feeds

Four Flute Square End Mills

Diameter Range
0.0625" ~ 0.1250"

B
END MILLS

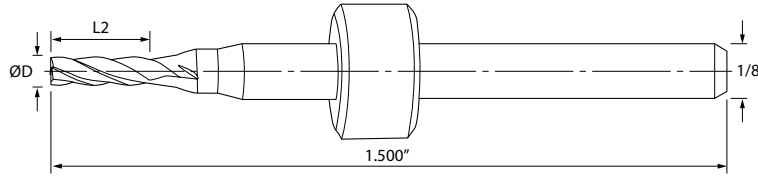

STANDARD Flute Length (Inch)



Part Number	Stock	End Mill Size	Dimensions (in)		Helix Angle
			Cutting Diameter	Flute Length	
			ØD	L2	
1800.0625.200	●	1/16"	0.0625	0.2000	30°
1800.0938.438	●	3/32"	0.0938	0.4380	30°
1800.1250.500	●	1/8"	0.1250	0.5000	30°

Four flute end mill designed for routing or milling printed circuit boards.

 Part Numbers above include rings set at 0.800" - For Ringless Part Number, replace series "." with "-" (XXX-XXXX.XXXX)
Additional diameters and special ring colors available upon request.

 For recommended cutting conditions please visit:
www.kyoceraprecisiontools.com/pcb/speeds-feeds

ROUTERS

A large, bold, red letter 'C' is centered within a white circular shape that is partially cut off at the top and bottom by the red header and footer respectively.

C1 - C12

Routers	C1 - C12
Series 1300 - Premium Edge Routers	C2
Series 2300 - Chipbreaker Routers	C4
Series 2350 - Low Fracture Routers	C5
Series 2390 - Flash Routers	C8
Series 4100 - Cross Cut Routers	C9

Gold Tab

Premium Edge Routers

Diameter Range
1.60mm ~ 2.40mm

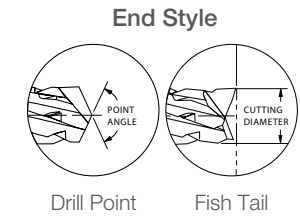
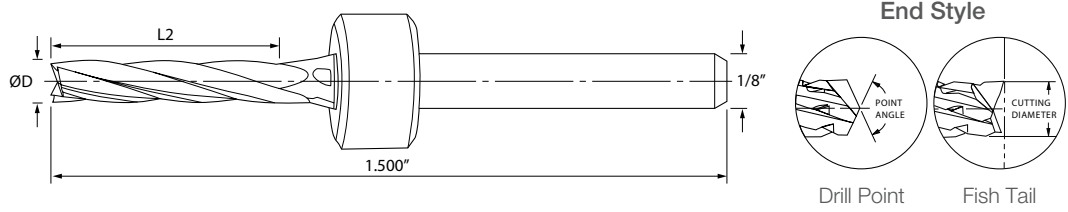

STANDARD Flute Length (Metric)

Part Number	Stock	Router Size	Dimensions (mm)		End Style
			Cutting Diameter	Flute Length	
			ØD	L2	
1300.0630.310	●	1.60mm	1.588	7.87	Drill Point
1300.0945.395	●	2.40mm	2.400	10.03	Fish Tail

Multiple flute cutter designed for routing printed circuit board gold tab connectors and plated solder features.

 Part Numbers above include rings set at 0.800" - For Ringless Part Number, replace series "." with "-" (XXX-XXXX.XXXX)
Additional diameters and special ring colors available upon request.

 For recommended cutting conditions please visit:
www.kyoceraprecisiontools.com/pcb/speeds-feeds

Chipbreaker

Updraft Fish Tail Routers

Diameter Range
0.0500" ~ 0.1250"
0.80mm ~ 3.00mm

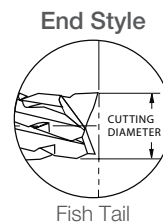
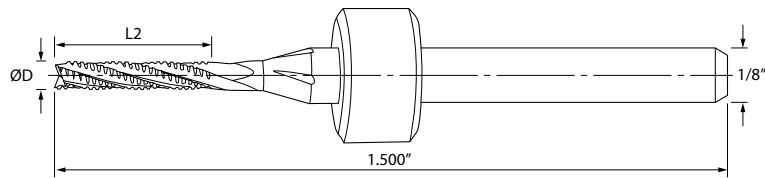

STANDARD Flute Length (Inch)

Part Number	Stock	Router Size	Dimensions (in)		End Style
			Cutting Diameter	Flute Length	
			ØD	L2	
2300.0500.256	●	0.0500"	0.0500	0.2560	Fish Tail
2300.1250.472	●	1/8"	0.1250	0.4720	Fish Tail

STANDARD Flute Length (Metric)

Part Number	Stock	Router Size	Dimensions (mm)		End Style
			Cutting Diameter	Flute Length	
			ØD	L2	
2300.0315.197	●	0.80mm	0.800	5.00	Fish Tail
2300.0354.197	●	0.90mm	0.900	5.00	Fish Tail
2300.0394.256	●	1.00mm	1.000	6.50	Fish Tail
2300.0472.256	●	1.20mm	1.200	6.50	Fish Tail
2300.0512.256	●	1.30mm	1.300	6.50	Fish Tail
2300.0551.256	●	1.40mm	1.400	6.50	Fish Tail
2300.0591.315	●	1.50mm	1.500	8.00	Fish Tail
2300.0630.315	●	1.60mm	1.600	8.00	Fish Tail
2300.0669.315	●	1.70mm	1.700	8.00	Fish Tail
2300.0709.315	●	1.80mm	1.800	8.00	Fish Tail
2300.0748.315	●	1.90mm	1.900	8.00	Fish Tail
2300.0787.315	●	2.00mm	2.000	8.00	Fish Tail
2300.0787.394	●	2.00mm	2.000	10.00	Fish Tail
2300.0827.394	●	2.10mm	2.100	10.00	Fish Tail
2300.0945.394	●	2.40mm	2.400	10.00	Fish Tail
2300.0984.394	●	2.50mm	2.500	10.00	Fish Tail
2300.1004.394	●	2.55mm	2.550	10.00	Fish Tail
2300.1181.394	●	3.00mm	3.000	10.00	Fish Tail



Chipbreaker style updraft router designed for superior edge finish on external and internal cuts.



Part Numbers above include rings set at 0.800" - For Ringless Part Number, replace series "." with "-" (XXX-XXXX.XXXX)
 Additional diameters and special ring colors available upon request.



For recommended cutting conditions please visit:
www.kyoceraprecisiontools.com/pcb/speeds-feeds

DRILLS	A
END MILLS	B
ROUTERS	C
SCORING/ENGRAVING COUNTERSINKS	D
TECHNICAL	E
INDEX	F

Chipbreaker

Updraft Drill Point Routers

Diameter Range
0.0500" ~ 0.1250"
0.50mm ~ 2.40mm

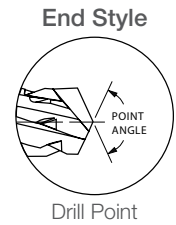
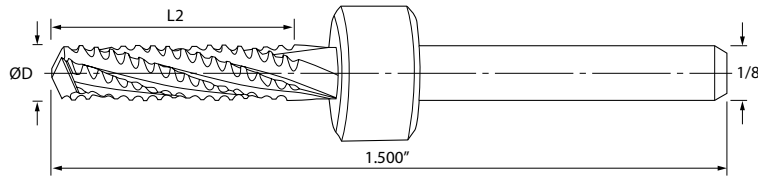

STANDARD Flute Length (Inch)

Part Number	Stock	Router Size	Dimensions (in)		End Style
			Cutting Diameter	Flute Length	
			ØD	L2	
2300.0500.256D	●	0.0500"	0.0500	0.2560	Drill Point
2300.1250.472D	●	1/8"	0.1250	0.4720	Drill Point

STANDARD Flute Length (Metric)

Part Number	Stock	Router Size	Dimensions (mm)		End Style
			Cutting Diameter	Flute Length	
			ØD	L2	
2300.0197.118D	●	0.50mm	0.500	3.00	Drill Point
2300.0315.197D	●	0.80mm	0.800	5.00	Drill Point
2300.0354.256D	●	0.90mm	0.900	6.50	Drill Point
2300.0394.256D	●	1.00mm	1.000	6.50	Drill Point
2300.0472.256D	●	1.20mm	1.200	6.50	Drill Point
2300.0512.256D	●	1.30mm	1.300	6.50	Drill Point
2300.0551.256D	●	1.40mm	1.400	6.50	Drill Point
2300.0630.256D	●	1.60mm	1.600	6.50	Drill Point
2300.0630.315D	●	1.60mm	1.600	8.00	Drill Point
2300.0787.394D	●	2.00mm	2.000	10.00	Drill Point
2300.0945.394D	●	2.40mm	2.400	10.00	Drill Point

Chipbreaker style updraft router designed for superior edge finish on external and internal cuts.

 Part Numbers above include rings set at 0.800" - For Ringless Part Number, replace series "." with "-" (XXX-XXXX.XXXX) Additional diameters and special ring colors available upon request.

 For recommended cutting conditions please visit: www.kyoceraprecisiontools.com/pcb/speeds-feeds

Series 2350

Fracture Reducing Router

Kyocera Precision Tools Series 2350 Fracture Reducing Router Design

Driving down the costs in drill and fab operations has been the value proposition of Kyocera Precision Tools since its founding in 1987. Continuing to provide value, Kyocera Precision Tools introduces a new router design that reduces edge fracturing in many applications where fractured edges are a concern. The new tool design combines the advantages provided by end mills for edge quality and the chipbreaker router for debris evacuation. In addition, these tools generally eliminate the requirement of entry material that is sometimes needed on this type of work when using conventional cutters.

Series 2350 Performance

Lab and beta site tests were conducted to ensure the product performed at an improved level that is both reliable and repeatable. Example results are provided below.

Testing Parameters	
Material :	Polyimide
Board Thickness :	0.063"
Diameter :	1.60mm

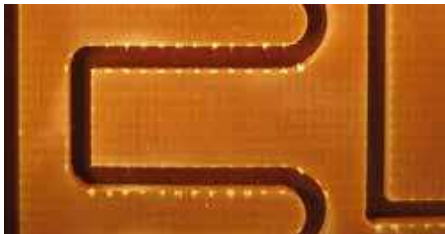
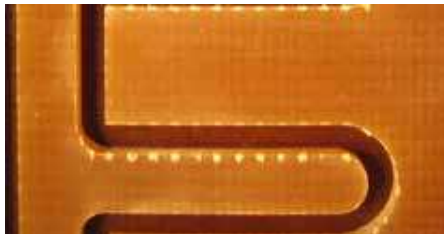
New 2350 Series Minimal to no fracturing detected on routed edges	Standard Chipbreaker Notable fracturing detected on routed edges	Standard Diamond Cut Elevated fracturing detected on routed edges
		

Users of the Series 2350 routers report 70% to 94% reduced fracturing when comparing to other router designs. Please contact a Kyocera Precision Tools field engineer for process assistance.

Low Fracture Updraft Fish Tail Routers

Diameter Range
1.20mm

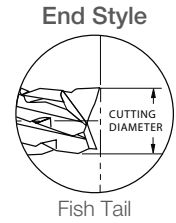
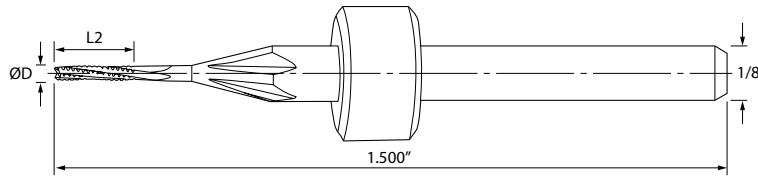

STANDARD Flute Length (Metric)

Part Number	Stock	Router Size	Dimensions (mm)		End Style
			Cutting Diameter	Flute Length	
			ØD	L2	
2350.0472.276	●	1.20mm	1.200	7.000	Fish Tail

Chipbreaker style updraft router designed with a cutting force reduction geometry leading to minimal routed edge fracturing and superior edge finish.

 Part Numbers above include rings set at 0.800" - For Ringless Part Number, replace series "." with "-" (XXX-XXXX.XXXX)
Additional diameters and special ring colors available upon request.

 For recommended cutting conditions please visit:
www.kyoceraprecisiontools.com/pcb/speeds-feeds

Low Fracture Updraft Drill Point Routers

Diameter Range
0.80mm ~ 2.40mm

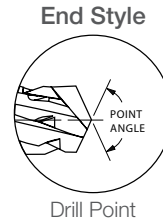
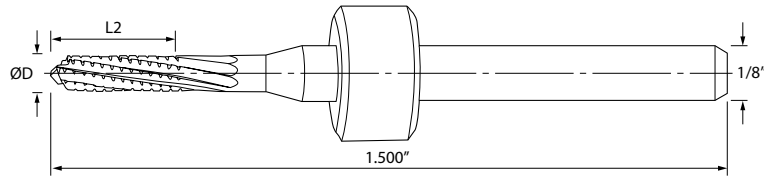

STANDARD Flute Length (Metric)

Part Number	Stock	Router Size	Dimensions (mm)		End Style
			Cutting Diameter	Flute Length	
			ØD	L2	
2350.0315.177D	●	0.80mm	0.800	4.50	Drill Point
2350.0394.177D	●	1.00mm	1.000	4.50	Drill Point
2350.0492.197D	●	1.25mm	1.250	5.00	Drill Point
2350.0630.256D	●	1.60mm	1.600	6.50	Drill Point
2350.0787.276D	●	2.00mm	2.000	7.00	Drill Point
2350.0945.315D	●	2.40mm	2.400	8.00	Drill Point



Chipbreaker style updraft router designed with a cutting force reduction geometry leading to minimal routed edge fracturing and superior edge finish.

DRILLS	A
END MILLS	B
ROUTERS	C
SCORING/ENGRAVING COUNTERSINKS	D
TECHNICAL	E
INDEX	F



Part Numbers above include rings set at 0.800" - For Ringless Part Number, replace series "." with "-" (XXX-XXXX.XXXX)
Additional diameters and special ring colors available upon request.



For recommended cutting conditions please visit:
www.kyoceraprecisiontools.com/pcb/speeds-feeds

Flash

Updraft Fish Tail Routers

Diameter Range
0.0938" ~ 0.1250"

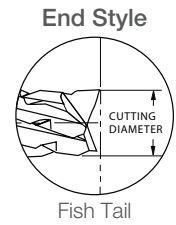
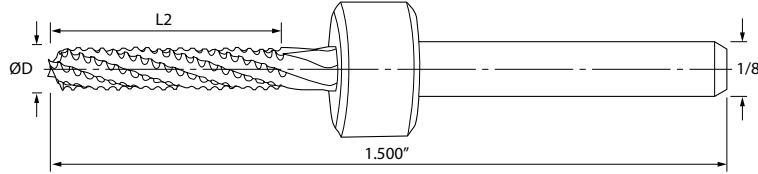

STANDARD Flute Length (Inch)

Part Number	Stock	Router Size	Dimensions (in)		End Style
			Cutting Diameter	Flute Length	
			ØD	L2	
2390.0938.500	●	3/32"	0.0938	0.495	Fish Tail
2390.1250.590	●	1/8"	0.1250	0.585	Fish Tail

Chipbreaker style updraft router designed for high stack routing with superior edge finish on external cuts.

 Part Numbers above include rings set at 0.800" - For Ringless Part Number, replace series "." with "-" (XXX-XXXX.XXXX)
Additional diameters and special ring colors available upon request.

 For recommended cutting conditions please visit:
www.kyoceraprecisiontools.com/pcb/speeds-feeds

Series 4100

Cross Cut Router Design

Driving down the costs in drill and fab operations has been the value proposition of Kyocera Precision Tools since its founding in 1987. As part of this proposition, Kyocera Precision Tools introduces a revolutionary router design that outlasts previous router designs on a variety of applications. The 4100 tool design combines the advantages of the classical Chip Breaker and Diamond Cut designs to provide a high strength, superior edge finish, long lasting router.

Series 4100 Performance

Lab and beta site tests were conducted to ensure the product performed at an improved level that is both reliable and repeatable. Test data is summarized below.

Testing Parameters	
Material :	High Tg
Thickness :	0.177"
Diameter :	0.0630"

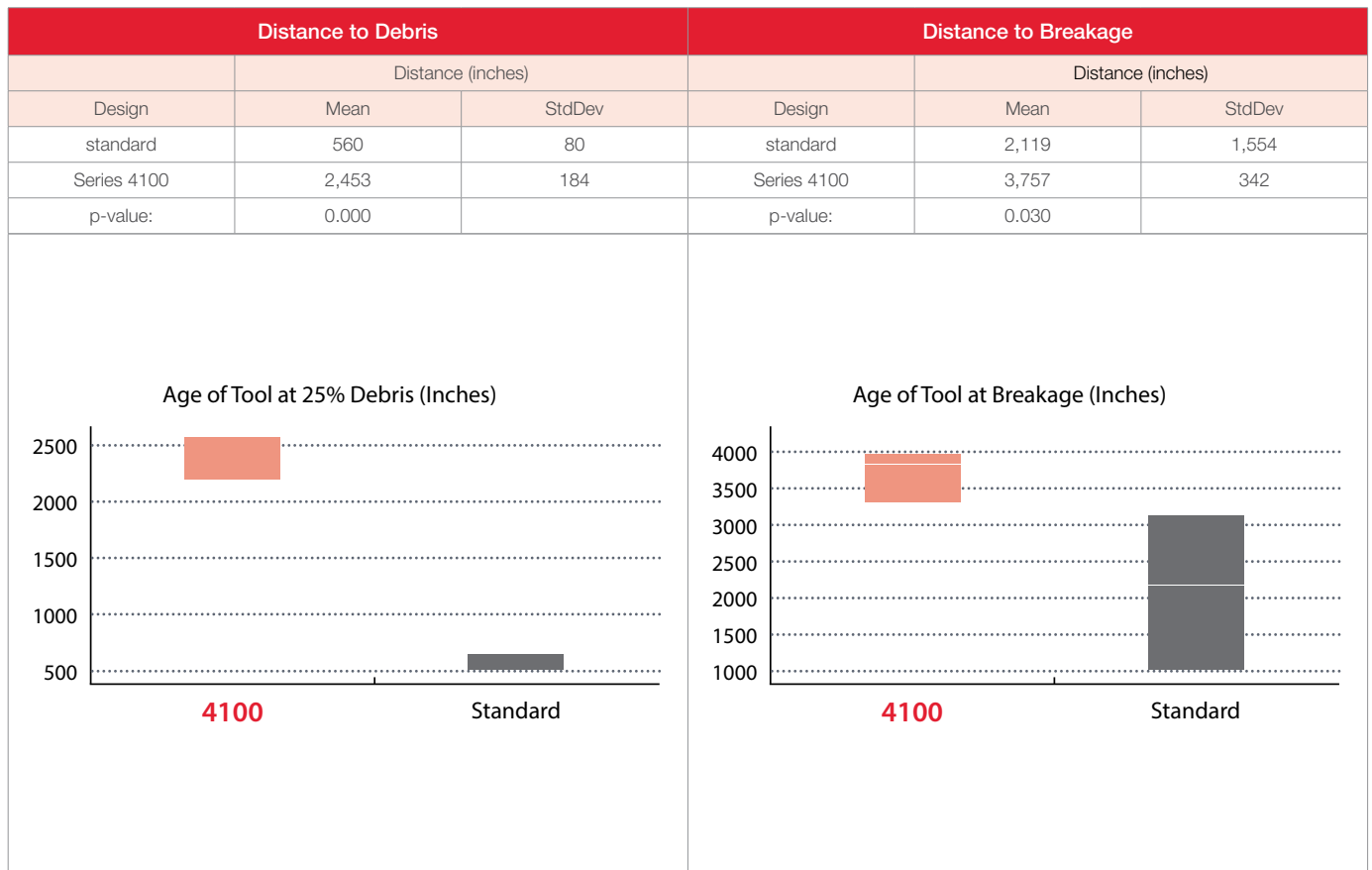

DRILLS	A
END MILLS	B
ROUTERS	C
SCORING/ENGRAVING COUNTERSINKS	D
TECHNICAL	E
INDEX	F

Cross Cut

Updraft Fish Tail Routers

Diameter Range
0.1250"
0.50mm ~ 2.60mm

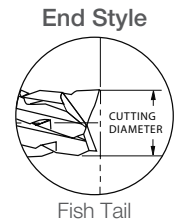
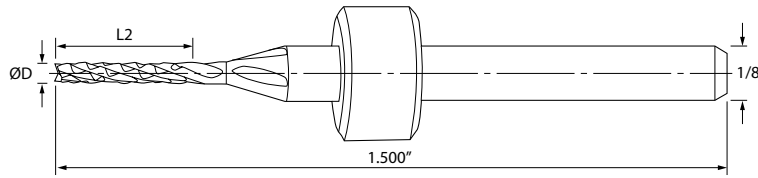

STANDARD Flute Length (Inch)

Part Number	Stock	Router Size	Dimensions (in)		End Style
			Cutting Diameter	Flute Length	
			ØD	L2	
4100.1250.472	●	1/8"	0.1250	0.472	Fish Tail

STANDARD Flute Length (Metric)

Part Number	Stock	Router Size	Dimensions (mm)		End Style
			Cutting Diameter	Flute Length	
			ØD	L2	
4100.0197.079	●	0.50mm	0.500	2.00	Fish Tail
4100.0236.118	●	0.60mm	0.600	3.00	Fish Tail
4100.0236.157	●	0.60mm	0.600	4.00	Fish Tail
4100.0276.177	●	0.70mm	0.700	4.50	Fish Tail
4100.0315.197	●	0.80mm	0.800	5.00	Fish Tail
4100.0315.256	●	0.80mm	0.800	6.50	Fish Tail
4100.0354.197	●	0.90mm	0.900	5.00	Fish Tail
4100.0354.256	●	0.90mm	0.900	6.50	Fish Tail
4100.0394.197	●	1.00mm	1.000	5.00	Fish Tail
4100.0394.256	●	1.00mm	1.000	6.50	Fish Tail
4100.0394.276	●	1.00mm	1.000	7.00	Fish Tail
4100.0433.256	●	1.10mm	1.100	6.50	Fish Tail
4100.0472.276	●	1.20mm	1.200	7.00	Fish Tail
4100.0500.276	●	1.27mm	1.270	7.00	Fish Tail
4100.0512.276	●	1.30mm	1.300	7.00	Fish Tail
4100.0551.256	●	1.40mm	1.400	6.50	Fish Tail
4100.0591.315	●	1.50mm	1.500	8.00	Fish Tail
4100.0630.256	●	1.60mm	1.600	6.50	Fish Tail
4100.0630.315	●	1.60mm	1.600	8.00	Fish Tail
4100.0669.315	●	1.70mm	1.700	8.00	Fish Tail
4100.0709.315	●	1.80mm	1.800	8.00	Fish Tail
4100.0748.315	●	1.90mm	1.900	8.00	Fish Tail
4100.0787.394	●	2.00mm	2.000	10.00	Fish Tail
4100.0945.394	●	2.40mm	2.400	10.00	Fish Tail
4100.0984.394	●	2.50mm	2.500	10.00	Fish Tail
4100.1004.394	●	2.55mm	2.550	10.00	Fish Tail
4100.1024.394	●	2.60mm	2.600	10.00	Fish Tail

Diamond cut style updraft router designed for high productivity routing.



Part Numbers above include rings set at 0.800" - For Ringless Part Number, replace series "." with "-" (XXX-XXXX.XXXX)
 Additional diameters and special ring colors available upon request.



For recommended cutting conditions please visit:
www.kyoceraprecisiontools.com/pcb/speeds-feeds

Cross Cut

Updraft Drill Point Routers

Diameter Range
0.0625" ~ 0.1250"
0.80mm ~ 2.55mm

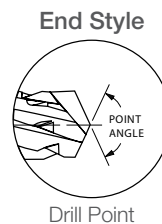
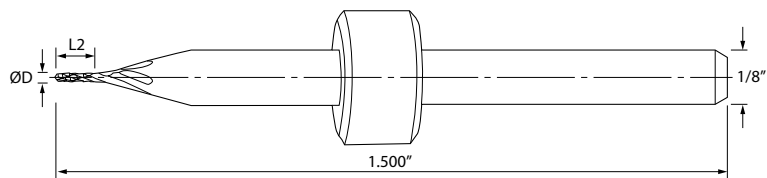

STANDARD Flute Length (Inch)

Part Number	Stock	Router Size	Dimensions (in)		End Style
			Cutting Diameter	Flute Length	
			ØD	L2	
4100.0625.315D	●	1/16"	0.0625	0.315	Drill Point
4100.0938.394D	●	3/32"	0.0938	0.394	Drill Point
4100.1250.472D	●	1/8"	0.1250	0.472	Drill Point

STANDARD Flute Length (Metric)

Part Number	Stock	Router Size	Dimensions (mm)		End Style
			Cutting Diameter	Flute Length	
			ØD	L2	
4100.0315.197D	●	0.80mm	0.800	5.00	Drill Point
4100.0354.197D	●	0.90mm	0.900	5.00	Drill Point
4100.0394.256D	●	1.00mm	1.000	6.50	Drill Point
4100.0472.276D	●	1.20mm	1.200	7.00	Drill Point
4100.0500.276D	●	1.27mm	1.270	7.00	Drill Point
4100.0709.315D	●	1.80mm	1.800	8.00	Drill Point
4100.0748.315D	●	1.90mm	1.900	8.00	Drill Point
4100.0787.315D	●	2.00mm	2.000	8.00	Drill Point
4100.0906.394D	●	2.30mm	2.300	10.00	Drill Point
4100.0984.394D	●	2.50mm	2.500	10.00	Drill Point
4100.1004.394D	●	2.55mm	2.550	10.00	Drill Point

Diamond cut style updraft router designed for high productivity routing.

DRILLS	A
END MILLS	B
ROUTERS	C
SCORING/ENGRAVING COUNTERSINKS	D
TECHNICAL	E
INDEX	F



Part Numbers above include rings set at 0.800" - For Ringless Part Number, replace series "." with "-" (XXX-XXXX.XXXX)
 Additional diameters and special ring colors available upon request.



For recommended cutting conditions please visit:
www.kyoceraprecisiontools.com/pcb/speeds-feeds

SCORING / ENGRAVING COUNTERSINKS

D

D1 - D4

SCORING & ENGRAVING

D2

SERIES 2002 - TWO FLUTE SCORING & ENGRAVING TOOLS

D2

COUNTERSINKS

D3 - D4

SERIES 2000 - ONE FLUTE COUNTERSINKS

D3

SERIES 2400 - FOUR FLUTE COUNTERSINKS

D4

Two Flute

Fluted Scoring Tools

Diameter Range
0.1250"
3.00mm

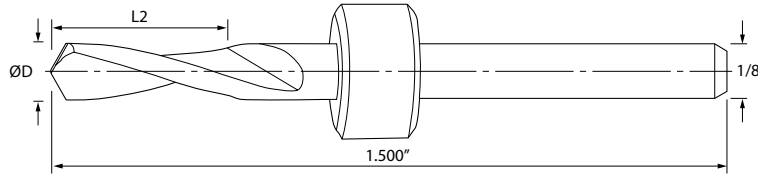

STANDARD Flute Length (Inch)



Part Number	Stock	Tool Size	Dimensions (in)		Point Angle
			Cutting Diameter	Flute Length	
			ØD	L2	
2002.0625.030	●	1/16"	0.625	0.551	30°
2002.1250.030	●	1/8"	0.1250	0.551	30°
2002.1250.045	●	1/8"	0.1250	0.551	45°
2002.1250.060	●	1/8"	0.1250	0.551	60°
2002.1250.090	●	1/8"	0.1250	0.551	90°
2002.1250.120	●	1/8"	0.1250	0.551	120°

Two flute scoring tool available with specified scoring angle.

STANDARD Flute Length (Metric)



Part Number	Stock	Tool Size	Dimensions (mm)		Point Angle
			Cutting Diameter	Flute Length	
			ØD	L2	
2002.1181.030	●	3.00mm	3.000	12.50	30°

 Part Numbers above include rings set at 0.800" - For Ringless Part Number, replace series "." with "-" (XXX-XXXX.XXXX)
 Additional diameters and special ring colors available upon request.

 For recommended cutting conditions please visit:
www.kyoceraprecisiontools.com/pcb/speeds-feeds

Single Flute Countersinks

Diameter Range
0.2500"

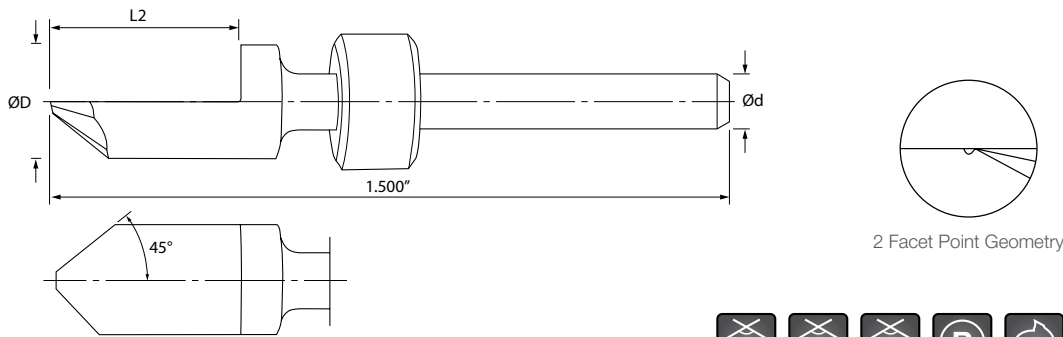

STANDARD Flute Length (Inch)



Part Number	Stock	Tool Size	Dimensions (in)			Point Angle
			Cutting Diameter	Flute Length	Shank Diameter	
			ØD	L2	Ød	
2000.2500.082A1	●	1/4"	0.2500	0.500	1/8"	82°
2000.2500.090A1	●	1/4"	0.2500	0.500	1/8"	90°
2000.2500.100A1	●	1/4"	0.2500	0.500	1/8"	100°

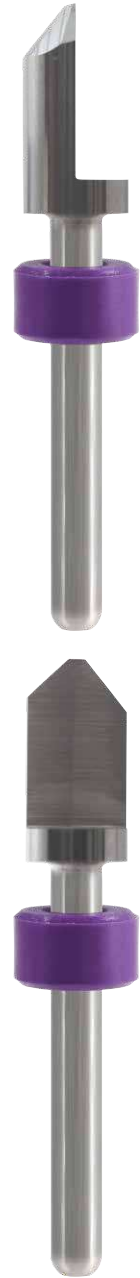

DRILLS	A
END MILLS	B
ROUTERS	C
SCORING / ENGRAVING COUNTERSINKS	D
TECHNICAL	E
INDEX	F

Single flute countersink tool with specified countersink angle.

Part Numbers above include rings set at 0.800" - For Ringless Part Number, replace series ".", with "-" (XXX-XXXX.XXXX)
Additional diameters and special ring colors available upon request.

For recommended cutting conditions please visit:
www.kyoceraprecisiontools.com/pcb/speeds-feeds

Four Flute Countersinks

Diameter Range
0.2500" - 0.6250"

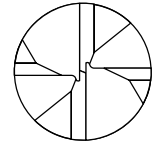
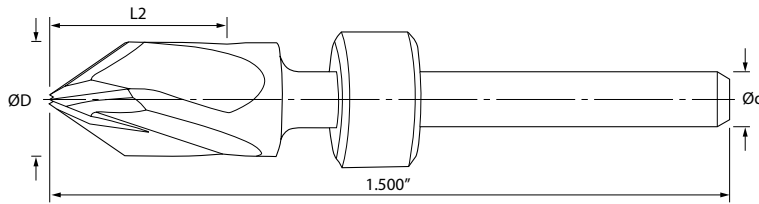

8 Facet Point Geometry

STANDARD Flute Length (Inch)



Part Number	Stock	Tool Size	Dimensions (in)			Point Angle
			Cutting Diameter	Flute Length	Shank Diameter	
			ØD	L2	Ød	
2400.2500.060G1	●	1/4"	0.2500	0.500	1/8"	60°
2400.2500.082	●	1/4"	0.2500	0.500	1/8"	82°
2400.2500.090	●	1/4"	0.2500	0.500	1/8"	90°
2400.2500.100	●	1/4"	0.2500	0.500	1/8"	100°
2400.2500.120	●	1/4"	0.2500	0.500	1/8"	120°
2400.2500.140	●	1/4"	0.2500	0.500	1/8"	140°
2400-6250.090A1	●	5/8"	0.6250	0.630	1/4"	90°

*Part Number 2400-6250.090A1 is a Ringless Part Number due to 1/4" Shank Diameter

Four flute countersink tool with specified countersink angle.



Part Numbers above include rings set at 0.800" - For Ringless Part Number, replace series "." with "-" (XXX-XXXX.XXXX)
Additional diameters and special ring colors available upon request.



For recommended cutting conditions please visit:
www.kyoceraprecisiontools.com/pcb/speeds-feeds

D
SCORING / ENGRAVING
COUNTERSINKS

TECHNICAL INFO



E

E1 - E4

DIAMETER CHART

E2

CARBIDE STUDY

E3

DIAMETER CHART

DRILL SIZE	DECIMAL INCH	DRILL SIZE	DECIMAL INCH	DRILL SIZE	DECIMAL INCH	DRILL SIZE	DECIMAL INCH
0.05mm	0.0020"	58	0.0420"	2.80mm	0.1102"	13	0.1850"
0.10mm	0.0040"	57	0.0430"	34	0.1110"	4.70mm	0.1850"
0.13mm	0.0050"	1.10mm	0.0433"	2.85mm	0.1122"	4.75mm	0.1870"
0.15mm	0.0059"	1.15mm	0.0453"	33	0.1130"	3/16"	0.1875"
97	0.0059"	56	0.0465"	2.90mm	0.1142"	4.80mm	0.1890"
96	0.0063"	3/64"	0.0469"	32	0.1160"	12	0.1890"
95	0.0067"	1.20mm	0.0472"	2.95mm	0.1161"	4.85mm	0.1909"
94	0.0071"	1.25mm	0.0492"	3.00mm	0.1181"	11	0.1910"
93	0.0075"	1.30mm	0.0512"	31	0.1200"	4.90mm	0.1929"
92	0.0079"	55	0.0520"	3.05mm	0.1201"	10	0.1935"
0.20mm	0.0079"	1.35mm	0.0531"	3.10mm	0.1220"	4.95mm	0.1949"
91	0.0083"	54	0.0550"	3.15mm	0.1240"	9	0.1960"
90	0.0087"	1.40mm	0.0551"	3.15mm	0.1240"	5.00mm	0.1968"
89	0.0091"	1.45mm	0.0571"	1/8"	0.1250"	5.05mm	0.1988"
88	0.0095"	1.50mm	0.0591"	3.20mm	0.1260"	8	0.1990"
0.25mm	0.0098"	53	0.0595"	3.25mm	0.1280"	5.10mm	0.2008"
87	0.0100"	1.55mm	0.0610"	30	0.1285"	7	0.2010"
86	0.0105"	1/16"	0.0625"	3.30mm	0.1299"	5.15mm	0.2028"
85	0.0110"	1.60mm	0.0630"	3.35mm	0.1319"	13/64"	0.2031"
84	0.0115"	52	0.0635"	3.40mm	0.1339"	6	0.2040"
0.30mm	0.0118"	1.65mm	0.0650"	3.45mm	0.1358"	5.20mm	0.2047"
83	0.0120"	1.70mm	0.0669"	29	0.1360"	5	0.2055"
82	0.0125"	1.75mm	0.0689"	3.50mm	0.1378"	5.25mm	0.2067"
81	0.0130"	51	0.0670"	3.55mm	0.1398"	5.30mm	0.2087"
80	0.0135"	1.75mm	0.0689"	28	0.1405"	4	0.2090"
0.35mm	0.0138"	50	0.0700"	9/64"	0.1406"	5.35mm	0.2106"
79	0.0145"	1.80mm	0.0709"	3.60mm	0.1417"	5.40mm	0.2126"
1/64"	0.0156"	1.85mm	0.0728"	3.65mm	0.1437"	3	0.2130"
0.40mm	0.0157"	49	0.0730"	27	0.1440"	5.45mm	0.2146"
78	0.0160"	1.90mm	0.0748"	3.70mm	0.1457"	5.50mm	0.2165"
0.45mm	0.0177"	48	0.0760"	26	0.1470"	5.55mm	0.2185"
77	0.0180"	1.95mm	0.0768"	3.75mm	0.1476"	7/32"	0.2188"
0.50mm	0.0197"	5/64"	0.0781"	25	0.1495"	5.60mm	0.2205"
76	0.0200"	47	0.0785"	3.80mm	0.1496"	2	0.2210"
75	0.0210"	2.00mm	0.0787"	3.85mm	0.1516"	5.65mm	0.2224"
0.55mm	0.0217"	2.05mm	0.0807"	24	0.1520"	5.70mm	0.2244"
74	0.0225"	46	0.0810"	3.90mm	0.1535"	5.75mm	0.2264"
0.60mm	0.0236"	45	0.0820"	23	0.1540"	1	0.2280"
73	0.0240"	2.10mm	0.0827"	3.95mm	0.1555"	5.80mm	0.2283"
72	0.0250"	2.15mm	0.0846"	5/32"	0.1562"	5.85mm	0.2302"
0.65mm	0.0256"	44	0.0860"	22	0.1570"	5.90mm	0.2323"
71	0.0260"	2.20mm	0.0866"	4.00mm	0.1575"	A	0.2340"
0.70mm	0.0276"	2.25mm	0.0886"	21	0.1590"	5.95mm	0.2343"
70	0.0280"	43	0.0890"	4.05mm	0.1594"	15/64"	0.2344"
69	0.0292"	2.30mm	0.0906"	20	0.1610"	6.00mm	0.2362"
0.75mm	0.0295"	2.35mm	0.0925"	4.10mm	0.1614"	B	0.2380"
68	0.0310"	42	0.0935"	4.15mm	0.1634"	6.05mm	0.2382"
1/32"	0.0312"	3/32"	0.0938"	4.20mm	0.1654"	6.10mm	0.2402"
0.80mm	0.0315"	2.40mm	0.0945"	19	0.1660"	C	0.2420"
67	0.0320"	41	0.0960"	4.25mm	0.1673"	6.15mm	0.2421"
66	0.0330"	2.45mm	0.0965"	4.30mm	0.1693"	6.20mm	0.2441"
0.85mm	0.0335"	40	0.0980"	18	0.1695"	D	0.2460"
65	0.0350"	2.50mm	0.0984"	4.35mm	0.1713"	6.25mm	0.2461"
0.90mm	0.0354"	39	0.0995"	11/64"	0.1719"	6.30mm	0.2480"
64	0.0360"	2.55mm	0.1004"	17	0.1730"	6.35mm	0.2500"
63	0.0370"	38	0.1015"	4.40mm	0.1732"	E	0.2500"
0.95mm	0.0374"	2.60mm	0.1024"	4.45mm	0.1752"	1/4"	0.2500"
62	0.0380"	37	0.1040"	16	0.1770"	6.40mm	0.2520"
61	0.0390"	2.65mm	0.1043"	4.50mm	0.1772"	6.50mm	0.2559"
1.00mm	0.0394"	2.70mm	0.1063"	4.55mm	0.1791"	F	0.2570"
60	0.0400"	36	0.1065"	15	0.1800"	6.60mm	0.2598"
59	0.0410"	2.75mm	0.1083"	4.60mm	0.1811"	G	0.2610"
1.05mm	0.0413"	7/64"	0.1094"	14	0.1820"	6.70mm	0.2638"
		35	0.1100"	4.65mm	0.1831"		

• Colors indicate standard ring (collar) colors

Kyocera Carbide Study – PCB Drills

After three years of development and qualification, Kyocera Corporation Carbide is now qualified on the Kyocera Precision Tool's (KPT) small to micro drill range for PCB Drills. Kyocera, one of the world's leading suppliers of carbide blanks developed carbide specifically for PCB applications and after several iterations of 8% and 6% formulations, became the preferred supplier for KPT PCB Drills. When evaluating suppliers, KPT strictly enforces the requirement that qualification means out-performing incumbent suppliers, especially in this case.

Kyocera carbide is the primary raw material supplier for KPT drill diameter range 0.0079" – 0.0453". KPT qualification consisted of several carbide grades and performance tests, below is the highest volume, micro drill results lengths:

Carbide Performance Comparison

Grain Structure and Homogeneity

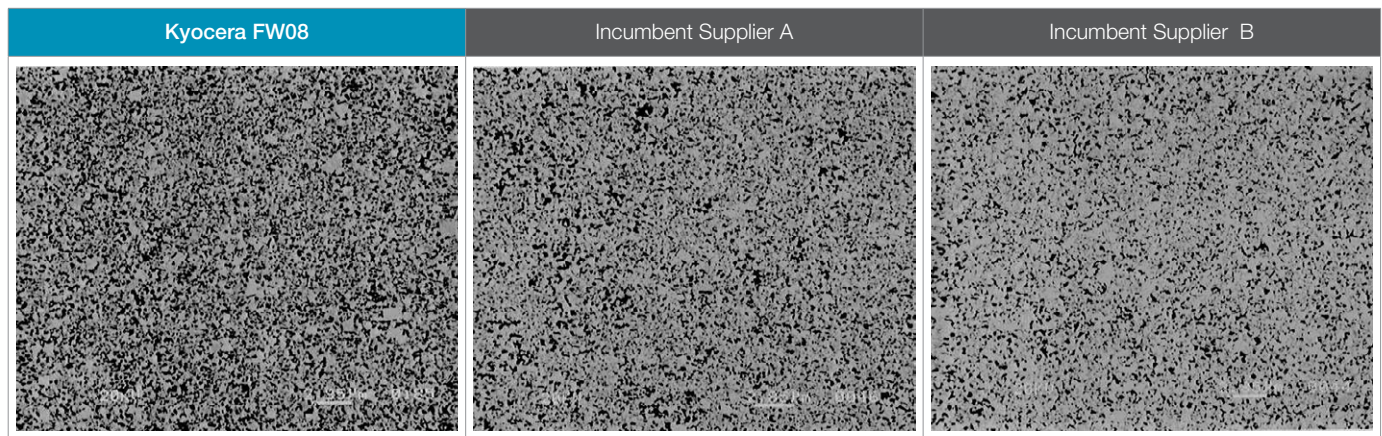

Performance Testing

Robustness and Positional Accuracy were the two primary performance metrics in the study. Kyocera FW08 met or exceeded the incumbent suppliers' performance in both cases.

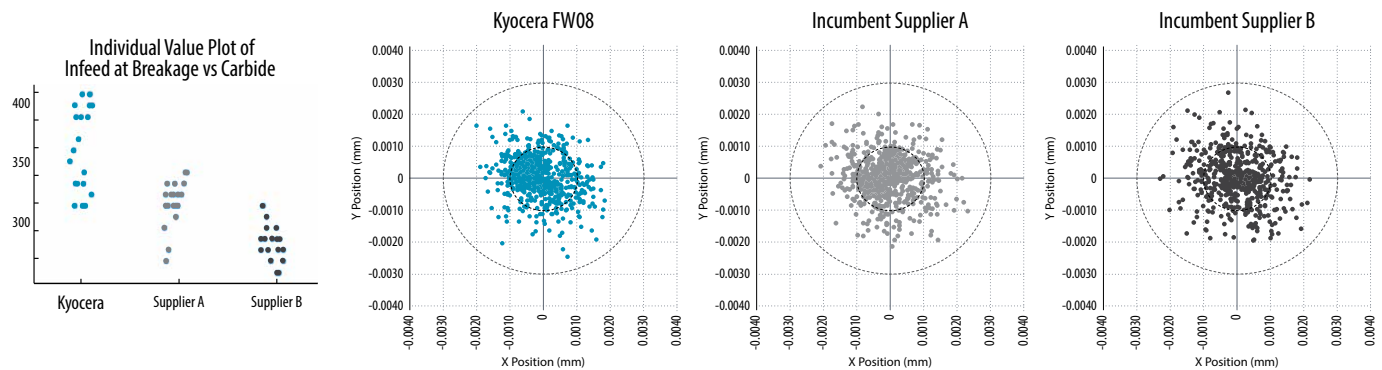

One-way ANOVA: Infeed at Breakage versus Carbide					
Source	DF	SS	MS	F	P
Carbide	2	301720	150860	52.06	0.000
Error	57	165180	2898		
Total	59	466900			

True Position Deviation			
	Mean	Std Dev	Median
Kyocera	0.0009807	0.0005157	0.0009493
Supplier A	0.0010761	0.0005583	0.000982
Supplier B	0.0011299	0.0005847	0.0010445

S = 53.83 | R-Sq = 64.62% | R-Sq(adj) = 63.38%

Level	N	Mean	StDev
Kyocera	20	306.00	75.70
Supplier A	20	206.00	41.09
Supplier B	20	133.00	35.70

DRILLS	A
END MILLS	B
ROUTERS	C
SCORING / ENGRAVING COUNTERSINKS	D
TECHNICAL	E
INDEX	F

F

F1

Part Numbers in Alphanumeric Order

○ : Number

<i>Part Number</i>	<i>Page</i>	<i>Description</i>
100 -○○○○.○○○	A3	Medium Non-Undercut Drill
102 -○○○○.○○○	A7	HDI /Blind Via Two Flute Tapered Non-Undercut Drill
150 -○○○○.○○○	A9	Large Non-Undercut Drill
240 -○○○○.○○○	A13	Straight Non-Undercut Drills for Flex Circuits
260 -○○○○.○○○	A14	Back Non-Undercut Drills
405 -○○○○.○○○	A15	Pilot Short Flute Undercut Drill
430 -○○○○.○○○	A16	Two into One Hybrid Flute Undercut Drill
460 -○○○○.○○○	A21	Superior Hole Wall Quality Standard Flute Undercut Drill
480 -○○○○.○○○	A21	Superior Hole Wall Quality Extended Flute Undercut Drill
560 -○○○○.○○○	A28	Accuracy Oriented Standard Flute Non-Undercut Drill
580 -○○○○.○○○	A29	Accuracy Oriented Extended Flute Non-Undercut Drill
700 -○○○○.○○○	A30	Reduced Deflection Non-Undercut Slot Drill
750 -○○○○.○○○	A32	Reduced Deflection Non-Undercut Slot Drill
1300 -○○○○.○○○	C2	Premium Edge Router
1500 -○○○○.○○○(D)	B2	One Flute End Mills
1560 -○○○○.○○○	B3	One Flute End Mills
1600 -○○○○.○○○	B4	Two Flute End Mills
1603 Q○○○○.○○○	B6	Two Flute Flat Point End Mills
1660 -○○○○.○○○	B7	Two Flute End Mills
1730 -○○○○.○○○	B8	Three Flute Zero Helix End Mills
1735 -○○○○.○○○	B9	Three Flute End Mills
1800 -○○○○.○○○	B12	Four Flute End Mills
2000 -○○○○.○○○	D3	One Flute Countersink
2002 -○○○○.○○○	D2	Two Flute Scoring & Engraving
2300 -○○○○.○○○(D)	C3	Chipbreaker Router
2350 -○○○○.○○○(D)	C5	Low Fracture Router
2390 -○○○○.○○○	C8	Flash Router
2400 -○○○○.○○○	D4	Four Flute Countersink
4100 -○○○○.○○○(D)	C9	Cross Cut Router



KYOCERA Precision Tools

1832 West Collins Ave
Orange, CA 92867
Customer Service | 888.848.9266
001-714-428-3611



Official Website | www.kyoceraprecisiontools.com
Email | pcb.cs@kyocerapcb.com