

GUHRING

High-Performance **TAPS**

2nd Edition - Includes 30 new series!



HIGH-PERFORMANCE TAPS

GUHRING

These 7 questions will help you identify the best Guhring tap for your application

QUESTION:

EXAMPLE ANSWER:

1) What is the material and material condition that is being machined?

1) 1018 steel \leq 20 Rc

2) Which material group (Guhring color ring) does this material belong to?

2) Yellow ring Quick Guide pg 14-15
(See Tap Material Compass section) Pgs 6-12
(Unalloyed Carbon Steel)

3) What hole type is being tapped?
- Blind or Through

3) Blind hole

4) What thread type is required?
- UNC, UNF, Metric, Metric Fine, NPT, NPTF?

4) 1/4-20, UNC

5) What is the thread tolerance required?
- Guhring standard taps are generally 2B and 3B class of fit for UNC and UNF taps, with an ISO2/6H class of fit for metric taps.

5) 2B

6) What standard tool dimensions are needed?
- ANSI standard
- DIN 371 (M1.4 - M10 standard metric pitch, reinforced shank)
- DIN 374 (M3 - M52 fine metric pitch, reduced shank)
- DIN 376 (M1.6 - M52 standard metric pitch, reduced shank)

6) ANSI standard
(see Technical section for information)

7) What is the thread depth that needs to be produced?
- Up to 1.5 x diameter
- 1.5 - 3 x diameter

7) \leq 3 x D

The suitable series for this example would be series 3904 (pg. 34) or 3964 (pg. 36).
See recommended pg. # for technical data.

Table of Contents

GENERAL INFORMATION

• Tap Compass / Material Selection Guide	Pages	6-12
• Material Hardness Cross Reference Chart	Page	13
• Quick Guide Color Ring Index	Pages	14-31

CUT TAPS

• For general purpose applications	Pages	33-44
• For alloyed & unalloyed steels	Pages	47-78
• Extended length taps: 4" and 6" OAL	Pages	60-63
• Taps for the Energy Industry	Pages	80-81
• For stainless steels & aerospace alloys	Pages	83-94
• For high-tensile and tool steels	Pages	97-118
• For titanium, nickel and their alloys	Pages	121-129
• UNJ / MJ / MFJ	Pages	130-135
• For cast iron & abrasive materials	Pages	137-153
• For aluminum & aluminum alloys	Pages	155-173

SPECIAL PITCH TAPS

• Oversize pitch diameters		
• STI - UNC	Page	64
• STI - UNF	Page	65
• EG-M	Page	78

FORM TAPS

• Technical overview - Form taps	Pages	177-179
• UNC/UNF	Pages	180-187
• Metric / Metric Fine	Pages	188-199
• Micro form taps	Page	191

PIPE TAPS

• NPT / NPTF	Page	94
--------------	------	----

TECHNICAL INFORMATION

• Definitions, flute forms, chamfer forms	Pages	218-220
• Tap tolerances and approx. limits	Pages	221-223
• Cutting rate recommendations	Pages	224-226
• DIN characteristic features for taps	Page	227
• Guhring substrate and coating descriptions	Page	228
• Tap drill sizes	Pages	229-239
• Troubleshooting	Pages	241-242

GUHRING NO. INDEX

• Cobalt, PM cobalt and carbide taps	Pages	243-248
--------------------------------------	-------	---------

A global company supporting the
global economy























































28 production plants
47 service centers
46 sales companies

























www.guhring.com











Your guide to proper color ring selection based on your material.

















Pages 6-12



Material	Condition	Hardness		GHRING COLOR RING			
		HRC	Brinell	Recommended	Alternate(s)		
 <p>Unalloyed Carbon Steels</p>	1005, 1006, 1008, 1009, 1010, 1011, 1012, 1013, 1015, 1016, 1017, 1018, 1019, 1020, 1021, 1022, 1023, 1025, 1026, 1029	Normalized, Hot rolled, Annealed, Cold drawn	-	≤ 180			
		Hot rolled, Normalized, Annealed, Cold drawn	≤ 20	≤ 230			
		Annealed, Cold drawn	≤ 30	≤ 280			
	1030, 1033, 1035, 1037, 1038, 1039, 1040, 1042, 1043, 1044, 1045, 1046, 1049, 1050, 1053, 1055, 1059	Hot rolled, Normalized, Annealed, Cold Drawn	-	≤ 180			
			≤ 20	≤ 230			
		Annealed, Cold drawn, Quenched and Tempered	≤ 30	≤ 280			
		Normalized, Annealed, Quenched and Tempered	≤ 35	≤ 320			
	Quenched and Tempered	≤ 38	≤ 350				
	1060, 1064, 1065, 1069, 1070, 1071, 1074, 1075, 1078, 1080, 1084, 1085, 1086, 1090, 1095	Hot rolled, Normalized, Annealed, Cold drawn	≤ 38	≤ 230			
		Hot rolled, Annealed, Cold drawn, Quenched and Tempered	≤ 20	≤ 280			
		Normalized, Annealed, Quenched and Tempered	≤ 35	≤ 320			
		Quenched and Tempered	≤ 38	≤ 350			
	<p>Free Machining Leaded Steels</p>	Low Carbon 10L10, 10L15, 10L17, 10L20, 10L23, 11L15, 11L16, 11L17, 12L11, 12L12, 12L13, 12L14, 12L15, 51L15, 1L17, 51L20	Hot rolled, Normalized, Annealed, Cold drawn	-	≤ 150		
				-	≤ 200		
				≤ 25	≤ 250		
		Medium Carbon 10L25, 10L30, 10L35, 10L40, 10L42, 10L45, 10L49, 10L50, 10L55, 86L20, 86L40, 11L37, 11L38, 11L39, 11L41, 11L44, 11L46, 41L25, 41L30, 41L35, 41L40, 41L42, 41L47, 41L50	Cold drawn, Quenched and Tempered	-	≤ 200		
≤ 25				≤ 250			
≤ 33			≤ 300				
≤ 38	≤ 350						
<p>Resulphurized Steels</p>	Low Carbon 1108, 1109, 1110, 1114, 1115, 1116, 1118, 1119, 1120, 1126, 1211, 1212, 1213, 1215	Hot rolled, Annealed	-	≤ 150			
		Cold drawn	-	≤ 200			
	Medium Carbon 1132, 1137, 1138, 1139, 1140, 1141, 1144, 1145, 1146, 1151	Hot rolled, Normalized, Annealed, Cold drawn	-	≤ 180			
			≤ 20	≤ 230			
		Cold drawn, Quenched and Tempered	≤ 30	≤ 280			
		Quenched and Tempered	≤ 35	≤ 320			
			≤ 38	≤ 350			

Material	Condition	Hardness		COLOR RING			
		HRC	Brinell	Recommended	Alternate(s)		
 <p>Carbon Manganese Steels</p>	Low Carbon	1513, 1518, 1522	Normalized, Hot rolled, Annealed, Cold drawn	-	≤ 180		
			Annealed, Cold drawn	≤ 20	≤ 230		
			Hot rolled, Normalized, Annealed, Cold drawn	≤ 30	≤ 280		
	Medium Carbon	1524, 1525, 1526, 1527, 1536, 1541	Hot rolled, Normalized, Annealed, Cold drawn	-	≤ 180		
				≤ 20	≤ 230		
			Hot rolled, annealed, cold drawn, normalized, quenched & tempered	≤ 30	≤ 280		
			Normalized, Annealed, Quenched and Tempered	≤ 35	≤ 320		
	Quenched and Tempered	≤ 38	≤ 350				
	High Carbon	1547, 1548 (46Mn5), 1551 (52Mn4), 1552 (52Mn5), 1561, 1566 (66Mn4), 1572 (80Mn4)	Hot rolled, Normalized, Annealed, Cold Drawn	≤ 20	≤ 230		
			Hot rolled, annealed, cold drawn, normalized, quenched & tempered	≤ 30	≤ 280		
			Normalized, Annealed, Quenched and Tempered	≤ 35	≤ 320		
			Quenched and Tempered	≤ 38	≤ 350		

Structural Steels	Yield Strength in 1000 PSI	30, 35, 42, 45, 50	Hot rolled, Normalized, Stress relieved	-	≤ 150		
		55, 60, 65		-	≤ 200		
		70, 75, 80	Hot rolled, Normalized, Stress relieved, Quenched and Tempered	≤ 25	≤ 250		
		85, 90, 100, 110		≤ 30	≤ 300		
		135, 140, 145, 150, 160	Quenched and Tempered	≤ 33	≤ 350		

Boron Treated Steels	Low Carbon Manganese Steels	10B08, 10B15, 10B16, 10B21, 10B22, 10B23	Normalized, Hot rolled, Annealed, Cold drawn	-	≤ 180		
				≤ 20	≤ 230		
			Annealed, Cold drawn	≤ 30	≤ 280		
	Medium Carbon Manganese Steels	10B30, 10B35, 10B37, 10B38, 10B39, 10B40, 10B41, 10B45, 10B50, 10B62, 13B20, 15B22, 15B47	Hot rolled, Normalized, Annealed, Cold drawn	-	≤ 180		
				≤ 20	≤ 230		
			Hot rolled, cold drawn, annealed, normalized, quenched & tempered	≤ 30	≤ 280		
			Normalized, Annealed, Quenched and Tempered	≤ 35	≤ 320		
			Quenched and Tempered	≤ 38	≤ 350		

Continues on next page

Material











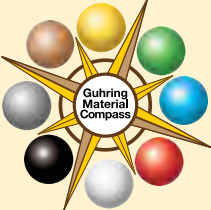





Condition

















Hardness



















GUHRING
COLOR RING









HRC Brinell









Recommended Alternate(s)



























 <p>Boron Treated Steels</p>	<p>Low Carbon Alloyed Steels</p> <p>32B15, 41B18, 51B15, 51B17, 51B20, 86B20, 86B22, 94B15, 94B17</p>	Hot rolled, Annealed, Cold drawn	≤ 20	≤ 230		
		Hot rolled, Annealed, Cold drawn, Normalized	≤ 30	≤ 280		
		Normalized, Quenched and Tempered	≤ 35	≤ 320		
	≤ 38		≤ 350			
	<p>Medium Carbon Alloyed Steels</p> <p>51B30, 51B32, 51B40, 51B55, 92B55, 50B40, 50B44, 50B46, 50B50, 50B60, 51B60, 81B45, 86B45, 94B30, 94B40</p>	Hot rolled, Annealed, Cold drawn	≤ 20	≤ 230		
		Normalized, cold drawn, annealed, quenched & tempered	≤ 30	≤ 280		
Normalized, Quenched and Tempered		≤ 35	≤ 320			
		≤ 38	≤ 350			





<p>Alloy Steels</p>	<p>Low Carbon</p> <p>2317, 2512, 2515, 2517, 3115, 3120, 3215, 3220, 3312, 3316, 3325, 4012, 4023, 4024, 4027, 4028, 4118, 4119, 4125, 4317, 4320, 4419, 4422, 4427, 4608, 4615, 4617, 4620, 4621, 4626, 4718, 4720, 4815, 4817, 4820, 5015, 5115, 5117, 5120, 6115, 6118, 6120, 6125, 8115, 8615, 8617, 8620, 8622, 8625, 8627, 8720, 8822, 9310, 9315, 9317</p>	Hot rolled, Annealed, Cold drawn	≤ 20	≤ 230		
		Hot rolled, normalized, annealed, cold drawn	≤ 30	≤ 280		
		Normalized, Quenched and Tempered	≤ 35	≤ 320		
	≤ 38		≤ 350			
	<p>Medium Carbon</p> <p>1330, 1335, 1340, 1345, 3140, 3145, 3150, 3230, 3240, 3335, 3340, 3435, 3450, 4032, 4037, 4063, 4130, 4135, 4137, 4140, 4142, 4145, 4147, 4150, 4161, 4337, 4340, 4640, 5045, 5046, 5060, 5130, 5132, 5135, 5140, 5145, 5157, 5150, 5155, 5160, 6130, 6135, 6140, 6145, 6150, 7140, 6145, 6150, 7140, 8630, 8632, 8635, 8637, 8640, 8642, 8645, 8650, 8650, 8660, 8735, 8740, 8742, 9250, 9254, 9255, 9260, 9262, 9840, 9850, 2340</p>	Hot rolled, Annealed, Cold drawn	≤ 20	≤ 230		
		Annealed, normalized, cold drawn, quenched & tempered	≤ 30	≤ 280		
Normalized, Quenched and Tempered		≤ 35	≤ 320			
	≤ 38	≤ 350				

















<p>Stainless Steels, Wrought</p>	<p>Ferritic</p> <p>405, 409, 429, 430, 434, 436, 442, 446</p>	<p>Annealed</p>	-	≤ 185		
	<p>Austenitic</p> <p>201, 202, 301, 302B, 304, 304L, 305, 308, 309, 309S, 310, 310S, 314, 316, 316L, 317, 321, 330, 347, 348, 384, 385, Nitronic 32, Nitronic 33, Nitronic 40, Nitronic 50, Nitronic 60</p>		-	≤ 180		
		Annealed, Cold drawn	≤ 20	≤ 230		
		Cold drawn	≤ 30	≤ 280		
	<p>Martensitic</p> <p>1403, 410, 414, 420, 422, 431, 440A, 440B, 440C, 501, 502, Greek Ascology</p>	<p>Annealed</p>	-	≤ 180		
			≤ 20	≤ 230		
		<p>Quenched and Tempered</p>	≤ 30	≤ 280		
			≤ 35	≤ 320		
	≤ 38	≤ 350				











Material	Condition	Hardness		COLOR RING			
		HRC	Brinell	Recommended	Alternate(s)		
 Stainless Steels, Wrought	Precipitation Hardening	15-5PH, 16-6PH, 17-4PH, 17-7PH, 17-14CuMo, AF-71, AFC-77, AM-363, AM363, AM350, AM355, Custom450, Custom 455, HNM, PH13-8 Mo, PH14-8 Mo, PH15-7Mo, Stainless W	Annealed	-	≤ 200		
				≤ 25	≤ 250		
	Hardened	≤ 33	≤ 300				
		≤ 38	≤ 350				





Free Machining Stainless Steels	Medium Carbon	430F, 430F Se	Annealed	-	≤ 180		
		203 Ez, 303, 303 Se, 303 Ma, 303 Pb, 303 PlusX		Cold drawn	≤ 28	≤ 270	
		416, 416 Se, 416 PlusX, 420F, 420F Se, 440F, 440F Se	Annealed	-	≤ 180		
			Annealed, Cold drawn	≤ 23	≤ 240		
			Quenched and Tempered	≤ 35	≤ 320		



Tool Steels	High Speed Steels	M1, M2, M6, M10, T1, T2, T6	Annealed	≤ 25	≤ 250		
		M3-1, M3-2, M4, M7, M30, M33, M34, M36, M41, M42, M43, M44, M46, M47, T4, T5, T8, T15		-	≤ 220		
				≤ 29	≤ 270		
	Hot Works	H10, H11, H12, H13, H14, H19	-	≤ 200			
			≤ 25	≤ 250			
	Cold Works	A7, D2, D3, D4, D5, D7 A2, A3, A4, A5, A6, A8, A9, A10, O1, O2, O6, O7	Quenched and Tempered	≤ 38	≤ 350		
			-	≤ 200			
	Stock Resisting	S1, S2, S4, S5, S6, S7	-	≤ 250			
			≤ 25	≤ 250			
	Mold	P2, P3, P4, P5, P6, P20, P21	-	≤ 220			
			-	≤ 150			
	Special Purpose	F1, F2, L2, L3, L6	-	≤ 200			
			≤ 25	≤ 250			

 Tool Steels	Water Hardening	W1, W2, W5	Annealed	≤ 25	≤ 250		
	Nitriding	Nitalloy 125, Nitalloy 135, Nitalloy 135Mod, Nitalloy 225, Nitalloy 230, Nitalloy EZ, Nitalloy N, Nitrex 1				Normalized, Quenched and Tempered	≤ 30
							

		ASTM	SAE				
Gray Cast Iron	As cast	A159 G1800, A48 class 20	J431 G1800	-	≤ 180		
		A159 G2500, A48 class 25	J431 G2500	≤ 25	≤ 250		
		A159 G3000, A48 class 30, 5, 40	J431 G3000				
		A159 G3500, A48 class 45	J431 G3500				
		A159 G4000, A48 class 50	J431 G4000				
		A48 class 45					
	A48 class 55		As cast, Quenched and Tempered	≤ 35	≤ 320		
	A48 class 60						

		UNS	ASTM	SAE	DIN					
Ductile Cast Iron	Ferritic	F32800	A536 60-40-18	J434 D4018		Annealed	-	≤ 190		
		F33100	A536 65-45-12	J434 D4512						
	Ferritic / Pearlitic	F33800	A536 80-55-06	J434 D5506		As cast	-	≤ 220		
					GGG50, GGG60				≤ 25	≤ 250
	Pearlitic / Martensitic	F34800	A536 100-70-03	J434 D7003	GGG70	Normalized and Tempered	≤ 33	≤ 300		
	Martensitic	F36200	A536 120-90-02	J434 DQ&T	GGG80	Quenched and Tempered	≤ 36	≤ 330		











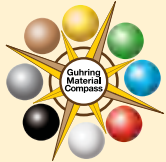















































		UNS	SAE						
High Alloy Cast Iron	Austenitic	F41000, F41001, F41006	A436 Type 1, A436 Type 1b, A436 Type 5	As cast	-	≤ 220			
		F41002, F41004, F41007	A436 Type 2, A436 Type 3, A436 Type 6				≤ 215		
		F41003, F41005	A436 Type 2b, A436 Type 4				≤ 25	≤ 250	

		UNS	SAE					
High Alloy Ductile Cast Iron	Austenitic	F43000, F43002, F43004, F43006, F43007, F43010	A439 D2, A439 D2C, A439 D3A, A439 D5, A439, 5B, A571 D2M	Annealed	-	≤ 200		
		F43001, F43003, F43005	A439 D2B, A439 D3, A439 D4				≤ 28	≤ 270

Material	Condition	Hardness		GHRING COLOR RING				
		HRC	Brinell	Recommended	Alternate(s)			
		UNS	ASTM / SAE					
 <p>Malleable Cast Iron</p>	Ferritic	F20000	A602 G M3210, J158 G M3210, A47 G 32510, A47 G 3201	Malleablized	-	≤ 160		
	Pearlitic	F22830, F23130, F23530, F20001, F20002	A220 G 40010, J125 pearlitic malleable, A220 G 45006, A220 G 45008, A220 G 50005, A602 G M4504, J158 G M4504, A602 G M5003, J158 G M5003	Malleablized and Heat Treated	-	≤ 200		
					≤ 23	≤ 240		
	Martensitic	F20003, F2410, F20004, F25530	A602 G M5503, J158 G M5503, A220 G 60004, A602 G M7002, J158 G M7002, A220 G 70003, A220 G 80002, A602 G M8501, J158 G M8501, A220 G 90001		≤ 26	≤ 255		
					≤ 27	≤ 260		
					≤ 30	≤ 280		
≤ 35					≤ 320			
<p>Aluminum</p>	Al Alloys, Wrought	Low Silicon	EC 1060, 1100, 1145, 1175, 1235, 2011, 2014, 2017, 2018, 2021, 2024, 2025, 2117, 2218, 2219, 2618, 3003, 3004, 3005, 4032, 5005, 5050, 5052, 5056, 5083, 5086, 5154, 5252, 5254, 5454, 5456, 5457, 5652, 5657, 6053, 6061, 6063, 6066, 6070, 6101, 6151, 6253, 6262, 6463, 6951, 7001, 7004, 7005, 7039, 7049, 7050, 7075, 7079, 7175, 7178	Cold drawn	-	30 to 80 500 kg		
				Solution treated and Aged	-	75 to 150 500 kg		
	Al Alloys, Wrought	≤ 7%	A140, 201.0, 208.0, 213.0, 222.0, 224.0, 242.0, 295.0, B295.0, 308.0, 319.0, 328.0, A332.0, F332.0, 333.0, 354.0, 355.0, C355.0, 356.0, A356.0, 357.0, 359.0, B443.0, 514.0, A514.0, 520.0, 535.0, 705.0, 707.0, A712.0, D712.0, 713.0, 771.0, 8500, A850.0, B850.0	As cast	-	40 to 100 500 kg		
				Solution treated and Aged	-	70 to 125 500 kg		
	Die Casting	7-10% Silicon	360.0, A360.0, 380.0, A380.0, C443.0, 518.0	As cast	-	40 to 100 500 kg		
				Solution treated and Aged	-	70 to 125 500 kg		
		7-14% Silicon	383.0, A384.0, 413.0, A413.0	As cast	-	40 to 100 500 kg		
				Solution treated and Aged	-	70 to 125 500 kg		
				As cast	-	40 to 100 500 kg		
				Solution treated and Aged	-	70 to 125 500 kg		
	≤ 14% Silicon	390.0, 392.0	As cast	-	40 to 100 500 kg			
			Solution treated and Aged	-	70 to 125 500 kg			
<p>Titanium Alloys, Wrought</p>	Commercially Pure	99.5	Annealed	-	≤ 170			
		99.2, 99.0, Ti-0.2Pd		-	≤ 200			
		99.0, 98.0, Ti-0.2Pd		≤ 29	≤ 275			
	Ti-8Mn, Ti2Al-11Sn-5Zr-1Mo, Ti-5Al-2, 5Sn ELI, Ti-5Al-6Sn-2Zr-1Mo, Ti-6Al-2Cb-1Ta-0.8Mo, Ti-6Al-2Sn-4Zr-2Mo, Ti-6Al-2Sn-4Zr-2Mo-.25Si, Ti-6Al-2Sn-4Zr-6Mo	≤ 37		≤ 340				
	Ti-6Al-4V, Ti-6Al-4V ELI	≤ 38		≤ 350				
	Ti-5Al-2Sn-2Zr-4Mo-4Cr (Ti-17), Ti-6Al-6V-2Sn, Ti-7Al-4Mo, Ti-8Al-1Mo-1V	≤ 40		≤ 370				
	Ti-1Al-8V-5Fe	≤ 41		≤ 380				

 Carbide taps are recommended for these materials

Continues on next page

Material	Condition	Hardness		GHRING COLOR RING				
		HRC	Brinell	Recommended	Alternate(s)			
 <p>Titanium Alloys, Wrought</p>	Alpha and Alpha-Beta Alloys	Ti-6Al-4V, Ti-6Al-4V ELI, Ti-6Al-2Sn-4Zr-2Mo, Ti-6Al-2Sn-4Zr-2Mo-.2Si, Ti-6Al-2Sn-4Zr-6Mo	Solution treated and Aged	≤ 41	≤ 380			
		Ti-1Al-8V-5Fe, Ti-3Al-2.5V, Ti-5Al-2Sn-2Zr-4Mo-4Cr (Ti-17), Ti-6Al-6V-2Sn, Ti-7Al-4Mo		≤ 46	≤ 440			
	Beta Alloys	Ti-3Al-8V-6Cr-4Mo-4Zr, Ti-8Mo-8V-2Fe-3Al, Ti-11.5Mo-6Zr-4.5Sn, Ti-10-2Fe-3Al, Ti-13V-11Cr-3Al	Annealed or Solution treated	≤ 38	≤ 350			
		Solution treated and Aged	≤ 46	≤ 440				
Titanium Alloys, Cast	Commercially Pure	99.0, Ti-0.2Pd, ASMT B367 Grades C-1, C-2, C-7A, C-7B	As Cast, As Cast and Annealed	-	≤ 200			
		99.0, Ti-0.2Pd, ASMT B367 Grades C-3, C-4, C-8A, C-8B		≤ 25	≤ 250			
	Alpha and Alpha-Beta Alloys	Ti-5Al-2Sn, Ti-6Al-4V, Ti-6Al-2Sn-4Zr-2Mo, Ti-8Al-1Mo-1V, ASMT B367 Grades C-5, C-6		≤ 35	≤ 320			
		≤ 38		≤ 350				
Chromium-Nickel	Alpha and Alpha-Beta Alloys	A560 ² 40 ² 375 Grade 50Cr-50Ni, 60Cr-40Ni	As Cast	≤ 41	≤ 375			
Nickel Alloys, Cast	Wrought and Cast	Nickel 200, Nickel 201, Nickel 205, Nickel 211, Nickel 220, Nickel 230	Annealed, Cold drawn	-	≤ 170			
		MONEL Alloy 400, MONEL Alloy 401, MONEL Alloy 404, MONEL Alloy R405; A2996 Grades CZ-100, M-35; A494 Grades CZ-100, M-35	Annealed, Cold drawn, As Cast	≤ 25	≤ 250			
		Incoloy Alloys, Inconel Alloys, Hastelloy Alloys, Rene, DURANICKEL Alloy 301, MONEL Alloy 502, MONEL Alloy K500, NI-SPAN-C Alloy 902, PERMANICKEL Alloy 300	Solution treated	≤ 35	≤ 320			
		Aged	≤ 39	≤ 360				
Magnesium Alloys	Wrought and Cast	Magnesium	As Cast	--	≤ 150			
Copper Alloys	Wrought and Cast	C10100, C27000, C71500, C52400, C77000, C17200, C71500, C95500, C86500, Beryllium Copper	Annealed, Cold drawn	--	≤ 120			
Brass	Wrought and Cast	CUZn10, CUZn20, 836, 838, Red Brass, Yellow Brass	Annealed, Cold drawn, As Cast	--	≤ 180			
Bronze	Phosphor Bronze	C5xxxx	Spring tempered	≤ 24	≤ 245			
	Aluminum Bronze	C60600, C64200, 952, 953	Annealed, Cold drawn		≤ 200			
	Manganese Bronze	862, 863, 865	Annealed, Cold drawn		≤ 225			
	Silicon Bronze	C64700, C66100, 878	As Cast		≤ 115			
Plastics		Thermoplastics, Duroplastics		--	--			

 Carbide taps are recommended for these materials

Material Hardness & Tensile Strength Cross-Reference Chart*

HARDNESS				TENSILE STRENGTH
Brinell	Vickers	Rockwell		PSI
		HRB	HRC	
76	80			
80.7	85	41.0		
85.5	90	48.0		
90.2	95	52.0		
95	100	58.2		
98.8	105			
105	110	62.3		
109	115			
114	120	66.7		57,000
119	125			59,000
124	130	71.2		61,000
128	135			63,000
133	140	75.0		66,000
138	145			68,000
143	150	78.7		70,000
147	155			72,000
152	160	81.7		73,000
156	165			74,000
162	170	85.0		79,000
166	175			81,000
171	180	87.1		83,000
176	185			86,000
181	190	89.5		88,000
185	195			90,000
190	200	91.6		91,000
195	205	92.6		92,000
199	210	93.5		95,000
204	215	94.0		98,000
209	220	95.0		102,000
214	225	96.0		105,000
219	230	96.7		107,000
223	235			109,000
228	240	98.1	20.3	111,000
233	245		21.3	113,000
238	250	99.5	22.2	116,000
242	255		23.1	118,000
247	260	101	24.0	122,000
252	265		24.8	124,000
257	270	102	25.6	126,000
261	275		26.4	129,000
266	280	104	27.1	131,000
271	285		27.8	134,000
276	290	105	28.5	138,000
280	295		29.2	139,000
285	300		29.8	142,000
295	310		31.0	146,000
304	320		32.2	150,000
314	330		33.3	154,000
323	340		34.4	159,000
333	350		35.5	164,000
342	360		36.6	169,000











HARDNESS				TENSILE STRENGTH
Brinell	Vickers	Rockwell		PSI
		HRB	HRC	
352	370		37.7	176,000
361	380		38.8	181,000
371	390		39.8	185,000
380	400		40.8	191,000
390	410		41.8	198,000
399	420		42.7	202,000
409	430		43.6	205,000
418	440		44.5	208,000
428	450		45.3	212,000
437	460		46.1	219,000
447	470		46.9	225,000
456	480		47.7	232,000
463	490		48.4	235,000
475	500		49.1	238,000
485	510		49.8	245,000
494	520		50.5	250,000
504	530		51.1	254,000
513	540		51.7	259,000
523	550		52.3	264,000
532	560		53.0	269,000
542	570		53.6	274,000
551	580		54.1	279,000
561	590		54.7	284,000
570	600		55.2	287,000
580	610		55.7	292,000
589	620		56.3	294,000
599	630		56.8	304,000
608	640		57.3	310,000
618	650		57.8	315,000
	660		58.3	326,000
	670		58.8	
	680		59.2	
	690		59.7	
	700		60.1	
	720		61.0	
	740		61.8	
	760		62.5	
	780		63.3	
	800		64.0	
	820		64.7	
	840		65.3	
	860		65.9	
	880		66.4	
	900		67.0	
	920		67.5	
	940		68.0	

* Figures listed are approximate. Actual conversions may vary by material and alloy content.

$$\text{PSI (pound / in}^2\text{)} = \text{N/mm}^2 \times 145.0377$$











$$\text{N/mm}^2 = \text{pound / in}^2 \div 145.0377$$

Yellow Ring / General Purpose Taps

Thread Depth			1.5 x Dia.	3 x Dia.	3 x Dia.
Flute Helix			Straight	Straight	Straight
Tool Substrate			HSS-E	HSS-E	HSS-E
Chamfer			2-3 "C"	3.5 - 5 "B"	3.5 - 5 "B"
Surface finish			○	○	Ⓜ
Coolant			External	External	External
 Through Hole / Plug Taps					
Thread type	Blank Style	Tolerance Zone	Series Number		
UNC	ANSI	2B	 3901 Pg. 34	 3961 Pg. 36	
UNF			 3902 Pg. 35	 3962 Pg. 37	
Metric		6H	 3900 Pg. 38	 3960 Pg. 39	
Metric Fine					
Metric	DIN 371	6H		803 Pg. 40	
	DIN 376			815 Pg. 41	
Metric Fine	DIN 374	6H	830 Pg. 44	827 Pg. 42	
Metric	DIN 357 w/Ext. OAL	6H		998 Pg. 43	

Yellow Ring / General Purpose Taps



Thread Depth			1.5 x Dia.	3 x Dia.	3 x Dia.
Flute Helix			Straight	40° Helix	40° Helix
Tool Substrate			HSS-E	HSS-E	HSS-E
Chamfer			2-3 "C"	2-3 "C"	2-3 "C"
Surface finish			○	○	Ⓜ
Coolant			External	External	External
 Blind Hole / Bottoming Taps					
Thread type	Blank Style	Tolerance Zone	Series Number		
UNC	ANSI	2B	 3904 Pg. 34	 3964 Pg. 36	
UNF			 3905 Pg. 35	 3965 Pg. 37	
Metric		6H	 3903 Pg. 38	 3963 Pg. 39	
Metric Fine					
Metric	DIN 371	6H		810 Pg. 40	
	DIN 376			822 Pg. 41	
Metric Fine	DIN 374	6H	830 Pg. 44	834 Pg. 43	



Green Ring - Alloyed & Unalloyed Steels

			3 x Dia.	3 x Dia.	3 x Dia.	3 x Dia.
Thread Depth			3 x Dia.	3 x Dia.	3 x Dia.	3 x Dia.
Flute Helix			Straight	Straight	Straight	Straight
Tool Substrate			HSS-E	HSS-E	HSS-E	HSS-E
Chamfer			3.5 - 5 "B"	3.5 - 5 "B"	3.5 - 5 "B"	3.5 - 5 "B"
Surface finish						
Coolant			External	External	External	External
 <p>Through Hole / Plug Taps</p>						
Thread type	Blank Style	Tolerance Zone	Series Number			
UNC	ANSI	2B	3913 Pg. 48	3916 Pg. 50	3946 Pg. 52	
	4" OAL ANSI		 4390 Pg. 60			
	6" OAL ANSI		 4285 Pg. 62			
UNF	ANSI	2B	3914 Pg. 49	3917 Pg. 51	3947 Pg. 53	
	4" OAL ANSI		 4282 Pg. 61			
	6" OAL ANSI		 4286 Pg. 63			
Metric	ANSI	6H	3912 Pg. 66	3915 Pg. 67	3945 Pg. 68	
Metric Fine				3973 Pg. 69		
Metric	DIN 371	6H				2876 Pg. 71
Metric Fine	DIN 374					2879 Pg. 71

Green Ring - Alloyed & Unalloyed Steels

Thread Depth		1.5 x Dia.	1.5 x Dia.	3 x Dia.	3 x Dia.	3 x Dia.	3 x Dia.	3 x Dia.	3 x Dia.	3 x Dia.	
Flute Helix		15° Helix	15° Helix	40° Helix	40° Helix	40° Helix	40° Helix	40° Helix	40° Helix	50° Helix	
Tool Substrate		HSS-E	HSS-E	HSS-E	HSS-E	HSS-E	HSS-E	HSS-E	HSS-E	HSS-E-PM	
Chamfer		2-3 "C"	1.5-2 "E"	2-3 "C"	2-3 "C"	2-3 "C"	2-3 "C"	1.5-2 "E"	1.5-2 "E"	2-3 "C"	
Surface finish											
Coolant		External	External	External	External	External	Axial	External	External	Axial	
 Blind Hole / Bottoming Taps											
Thread type	Blank Style	Tolerance Zone	Series Number								
UNC	ANSI	2B			3919 Pg. 48	3922 Pg. 50	3949 Pg. 52	3954 Pg. 59	3977 Pg. 58		
	4" OAL ANSI				4283 Pg. 60						
	6" OAL ANSI				4287 Pg. 62						
UNF	ANSI	2B			3920 Pg. 49	3923 Pg. 51	3950 Pg. 53	3955 Pg. 59	3978 Pg. 58		
	4" OAL ANSI				4284 Pg. 61						
	6" OAL ANSI				4288 Pg. 63						
Metric	ANSI	6H			3918 Pg. 66	3921 Pg. 67	3948 Pg. 68	4126 Pg. 70	3976 Pg. 70		
Metric Fine						3974 Pg. 69					
Metric	DIN 371	6H	4154 Pg. 72	4155 Pg. 73	889 Pg. 74					2790 Pg. 74	1152 Pg. 74
	DIN 376				890 Pg. 75					2791 Pg. 75	1293 Pg. 75
Metric Fine	DIN 374		4156 Pg. 72	4157 Pg. 73	2424 Pg. 76					2792 Pg. 76	1294 Pg. 76

Green Ring - Alloyed & Unalloyed Steels

Thread Depth		3 x Dia.		3 x Dia.	
Flute Helix		Straight		40° Helix	
Tool Substrate		HSS-E		HSS-E	
Chamfer		3.5 - 5 "B"		2-3 "C"	
Surface finish		S		S	
Coolant		External		External	
 Through Hole / Plug Taps				 Blind Hole / Bottoming Taps	
					
Thread type	Blank Style	Tolerance Zone	Series Number		
UNC	ANSI	H7	3982 Pg. 54		3980 Pg. 54
		H11	3986 Pg. 56		3984 Pg. 56
UNF		H7	3983 Pg. 55		3981 Pg. 55
		H11	3987 Pg. 57		3985 Pg. 57
Metric	DIN 371/376	6H +0.003"	NEW 4331 Pg. 77		NEW 4311 Pg. 77
(STI) UNC	ANSI	3B	3990 Pg. 64		3988 Pg. 64
(STI) UNF			3991 Pg. 65		3989 Pg. 65
EG Metric	DIN 40435	6H Mod.	1010 Pg. 78		1011 Pg. 78



TECH TIP: Heli-Coil or STI Taps – with EG designation (Metric and Metric Fine)

EG is the German equivalent of STI. Einsatz Gewinde translates to “Thread insert”

An EG (or STI) Tap is designed to create an oversized, threaded hole so it can accommodate the required Heli-Coil insert. Screw Thread Inserts are helically formed coils of diamond-shaped stainless steel or Phosphorous bronze wire that screw into a threaded hole to form a mating internal thread.

Screw Thread Inserts are a convenient way of repairing stripped out threads and are also used to provide stronger threads in soft materials than what can be obtained by directly tapping the base material. Aluminum, zinc die cast, magnesium and even wood are some materials that an STI may be used in.

Taps for the Energy Industry





Thread Depth			3 x Dia.		1.5 x Dia.
Flute Helix			40° Helix		Straight
Tool Substrate			HSS-E		HSS-E
Chamfer			2-3 "C"		2-3 "C"
Surface finish			S		C
Coolant			External		Axial
				 Blind Hole / Bottoming Taps	
Thread type	Blank Style	Tolerance Zone	Series Number		
UNC	DIN/ANSI	2B	NEW 4392 Pg. 80		
UNF			NEW 4393 Pg. 80		
8-PITCH			NEW 4289 Pg. 81		
Metric	DIN 376	6HX			778 Pg. 81
	DIN 376 w/Ext. OAL				779 Pg. 81

Blue Ring - Stainless Steel and Aerospace Alloys























Thread Depth			3 x Dia.	3 x Dia.	3 x Dia.
Flute Helix			Straight	Straight	Straight
Tool Substrate			HSS-E-PM	HSS-E	HSS-E-PM
Chamfer			3.5 - 5 "B"	3.5 - 5 "B"	3.5 - 5 "B"
Surface finish					
Coolant			External	External	External
 Through Hole / Plug Taps					
Thread type	Blank Style	Tolerance Zone	Series Number		
UNC	ANSI	2B	3907 Pg. 84		
		3B	3996 Pg. 86		
UNF	ANSI	2B	3908 Pg. 85		
		3B	3997 Pg. 87		
Metric	ANSI	6H	3906 Pg. 88		
Metric	DIN 371	6H			877 Pg. 89
	DIN 376			1872 Pg. 90	
Metric Fine	DIN 374			1873 Pg. 90	

Blue Ring - Stainless Steel and Aerospace Alloys



			1.5 x Dia.	3 x Dia.	3 x Dia.	2.5 x Dia.
Thread Depth			15° Helix	40° Helix	40° Helix	25° Helix
Flute Helix			HSS-E	HSS-E-PM	HSS-E-PM	HSS-E
Tool Substrate			2-3 "C"	2-3 "C"	2-3 "C"	2-3 "C"
Chamfer						
Surface finish			External	External	External	External
Coolant			 Blind Hole / Bottoming Taps			
						
Thread type	Blank Style	Tolerance Zone	Series Number			
UNC	ANSI	2B		3910 Pg. 84		
		3B		3998 Pg. 86		
UNF	ANSI	2B		3911 Pg. 85		
		3B		3999 Pg. 87		
Metric	ANSI	6H		3909 Pg. 88		
Metric	DIN 371	6H	2896 Pg. 91		909 Pg. 89	
	DIN 376		2895 Pg. 91		910 Pg. 93	
Metric Fine	DIN 374		2897 Pg. 92		936 Pg. 93	
NPT	Guhring Std.				1088 Pg. 94	
NPTF					4127 Pg. 94	

Red Ring - Hardened and Tool Steels

			Thread Depth	3 x Dia.	3 x Dia.	3 x Dia.		1.5 x Dia.	1.5 x Dia.	1.5 x Dia.	1.5 x Dia.	
			Flute Helix	Straight	Straight	Straight		Straight	Straight	Straight	Straight	
			Tool Substrate	HSS-E-PM	HSS-E	HSS-E		CARBIDE	HSS-E-PM	HSS-E-PM	HSS-E	
			Chamfer	3.5 - 5 "B"	3.5 - 5 "B"	3.5 - 5 "B"		3.5-5 "D"	2-3 "C"	1.5-2 "E"	2-3 "C"	
			Surface finish									
			Coolant	External	External	External		External	 Axial	 Axial	 Axial	
 Through Hole / Plug Taps												
Thread type	Blank Style	Tolerance Zone	Series Number									
UNC	DIN/ANSI	2B	3992 Pg. 98									
		2BX							4394 Pg. 104			
UNF		2B	3994 Pg. 99									
		2BX							4391 Pg. 104			
Metric		6H	4122 Pg. 105									
Metric Fine			4123 Pg. 106									
Metric		DIN 371	6H		804 Pg. 107	1914 Pg. 110						
		DIN 376			816 Pg. 108	1915 Pg. 111						
Metric Fine		DIN 374			828 Pg. 109							
Metric		DIN 371	6HX							302 Pg. 115	1091 Pg. 116	
	DIN 376								297 Pg. 115	4165 Pg. 116	778 Pg. 117	
Metric Fine	DIN 374								1090 Pg. 115	1007 Pg. 116		
Metric	DIN 376 w/Ext. OAL										779 Pg. 117	
Metric	Guhring Std.	6H						2944 Pg. 118				
Metric Fine								1161 Pg. 118				

Red Ring - Hardened and Tool Steels



Thread Depth	1.5 x Dia.	1.5 x Dia.	1.5 x Dia.	1.5 x Dia.	1.5 x Dia.	3 x Dia.	3 x Dia.	3 x Dia.	3 x Dia.
Flute Helix	15° Helix	15° Helix	15° Helix	15° Helix	15° Helix	40° Helix	40° Helix	40° Helix	40° Helix
Tool Substrate	HSS-E-PM	HSS-E-PM	HSS-E-PM	HSS-E-PM	HSS-E-PM	HSS-E-PM	HSS-E	HSS-E	HSS-E
Chamfer	2-3 "C"	2-3 "C"	1.5-2 "E"	1.5-2 "E"	2-3 "C"	2-3 "C"	2-3 "C"	2-3 "C"	2-3 "C"
Surface finish	S	A	C	C	C	S	○	C	○
Coolant	External	External	External	Axial	Axial	External	External	External	Axial
 Blind Hole / Bottoming Taps									

Thread type	Blank Style	Tolerance Zone	Series Number								
UNC	DIN/ ANSI	2B	4124 Pg. 100					3993 Pg. 98			
		2BX		NEW 4373 Pg. 102	NEW 4375 Pg. 102	NEW 4388 Pg. 101					
2B		4125 Pg. 100					3995 Pg. 99				
2BX			NEW 4374 Pg. 103	NEW 4376 Pg. 103	NEW 4389 Pg. 101						
Metric		6H					4120 Pg. 105				
Metric Fine		6H					4121 Pg. 106				
Metric		DIN 371	6H		1577 Pg. 113				811 Pg. 107	1916 Pg. 110	1894 Pg. 112
		DIN 376			1578 Pg. 113				823 Pg. 108	1917 Pg. 111	1901 Pg. 112
Metric Fine		DIN 374							835 Pg. 109		
Metric		DIN 371	6HX					1188 Pg. 114			
	DIN 376						1194 Pg. 114				
Metric Fine	DIN 374						1200 Pg. 114				

Grey Ring - Ti and Ni Alloys / Aerospace

			Ti	Ni		Ti	Ni
Thread Depth			≤2 x Dia.	≤2 x Dia.		≤2 x Dia.	≤2 x Dia.
Flute Helix			Straight	Straight		15° Helix	10° Helix
Tool Substrate			HSS-E-PM	HSS-E-PM		HSS-E-PM	HSS-E-PM
Chamfer			3.5-5 "B"	3.5-5 "B"		2-3 "C"	2-3 "C"
Surface finish							
Coolant			External	External		External	External
 Through Hole / Plug Taps					 Blind Hole / Bottoming Taps		
Thread type	Blank Style	Tolerance Zone	Series Number				
UNC	~DIN 371	2BX	2905 Pg. 122	2918 Pg. 126		2912 Pg. 122	2922 Pg. 126
	~DIN 376	2BX				2912 Pg. 122	2922 Pg. 126
UNF	~DIN 371	2BX	2907 Pg. 123	2919 Pg. 127		2914 Pg. 123	2923 Pg. 127
	~DIN 376	2BX				2914 Pg. 123	2923 Pg. 127
Metric	DIN 371	6HX	2901 Pg. 124	2916 Pg. 128		2909 Pg. 124	2920 Pg. 128
	DIN 376	6HX	2901 Pg. 124	2916 Pg. 128		2909 Pg. 124	2920 Pg. 128
Metric Fine	DIN 371	6HX	2903 Pg. 125	2917 Pg. 129		2910 Pg. 125	2921 Pg. 129

Grey Ring - Ti and Ni Alloys / Aerospace

			Ti / Ni		Ti	Ni
Thread Depth			$\leq 2 \times \text{Dia.}$		$\leq 2 \times \text{Dia.}$	$\leq 2 \times \text{Dia.}$
Flute Helix			Straight		15° Helix	10° Helix
Tool Substrate			HSS-E-PM		HSS-E-PM	HSS-E-PM
Chamfer			3.5-5 "B"		2-3 "C"	2-3 "C"
Surface finish			C		C	A
Coolant			External		External	External
 Through Hole / Plug Taps				 Blind Hole / Bottoming Taps		
Thread type	Blank Style	Tolerance Zone	Series Number			
UNJC	-DIN 371	3BX	1059 Pg. 130		1063 Pg. 130	1067 Pg. 134
	-DIN 376	3BX	1059 Pg. 130		1063 Pg. 130	1067 Pg. 134
UNJF	-DIN 371	3BX	1060 Pg. 131		1064 Pg. 131	1068 Pg. 134
	-DIN 376	3BX	1060 Pg. 131		1064 Pg. 131	1068 Pg. 134
Metric J	DIN 371	4HX	1057 Pg. 132		1061 Pg. 132	1065 Pg. 135
	DIN 376	4HX	1057 Pg. 132		1061 Pg. 132	1065 Pg. 135
Metric Fine J	DIN 371	4HX	1058 Pg. 133		1062 Pg. 133	1066 Pg. 135

If you have customers who are suppliers to the aerospace or military Industries, you will encounter “J” or “Controlled root radius” thread requirements.

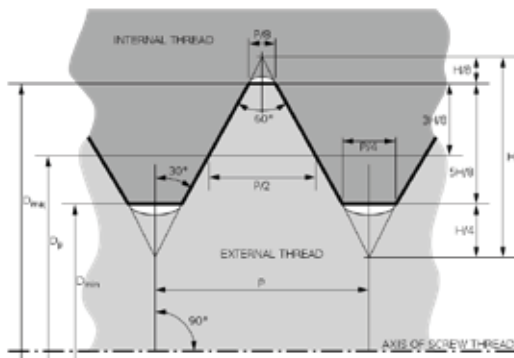













The differences between these and UNC or UNF threads are as follows:

The external thread is manufactured with radii in the root of the thread for added strength, and to extend the integrity of the threading tool.



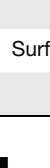
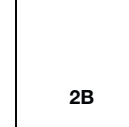
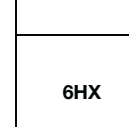
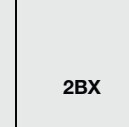
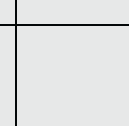
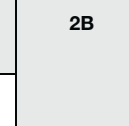
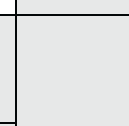
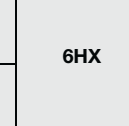

The internal thread is manufactured to 3B class of fit tolerancing for the pitch diameter, and will need to use a larger drill for the minor diameter to accommodate the root radius in the bolt.

ANY UN-3B tap will produce a legitimate “UNJ” internal thread.







White Ring - Cast Iron and Abrasive Materials

			3 x Dia.	3 x Dia.	3 x Dia.	3 x Dia.	3 x Dia.	3 x Dia.	3 x Dia.
Thread Depth			3 x Dia.	3 x Dia.	3 x Dia.	3 x Dia.	3 x Dia.	3 x Dia.	3 x Dia.
Flute Helix			Straight	Straight	Straight	Straight	Straight	Straight	Straight
Tool Substrate			HSS-E	HSS-E	HSS-E	HSS-E	HSS-E	HSS-E-PM	HSS-E-PM
Chamfer			2-3 "C"	2-3 "C"	2-3 "C"	2-3 "C"	2-3 "C"	1.5-2 "E"	2-3 "C"
Surface finish									
Coolant			External	External	External	 Axial	 Axial	 Axial	 Axial
 <p>Blind Hole or Through Hole Straight Flute Taps</p>									
Thread type	Blank Style	Tolerance Zone	Series Number						
UNC	ANSI	2B	3937 Pg. 138						
UNF			3938 Pg. 138						
Metric		6HX	3936 Pg. 144						
UNC	DIN/ANSI	2BX						 4394 Pg. 139	
UNF			 4391 Pg. 139						
UNC	DIN 371	2B		1979 Pg. 141		1085 Pg. 141			
	DIN 376		1984 Pg. 142		1086 Pg. 142				
UNF	DIN 374		1989 Pg. 143		1082 Pg. 143				
Metric	DIN 371	6HX		1918 Pg. 145	318 Pg. 145		1091 Pg. 149	302 Pg. 148	
	DIN 376		1919 Pg. 146	319 Pg. 146	778 Pg. 153	4165 Pg. 149	297 Pg. 148		
	DIN 376 w/Ext. OAL				779 Pg. 153				
Metric Fine	DIN 374			169 Pg. 147	347 Pg. 147		1007 Pg. 149	1090 Pg. 148	

White Ring - Cast Iron and Abrasive Materials

Thread Depth		3 x Dia.	3 x Dia.	3 x Dia.	3 x Dia.	
Flute Helix		Straight	Straight	Straight	Straight	
Tool Substrate		CARBIDE	CARBIDE	CARBIDE	CARBIDE	
Chamfer		2-3 "C"	1.5-2 "E"	2-3 "C"	2-3 "C"	
Surface finish		○	○	○	○	
Coolant		💧 Axial	💧 Axial	💧 Axial	💧 Radial	
 <p>Blind Hole or Through Hole Straight Flute Taps</p>						
Thread type	Blank Style	Tolerance Zone	Series Number			
UNC	DIN/ANSI	2BX	4118 Pg. 140			
UNF			4119 Pg. 140			
Metric	DIN 371	6HX		1008 Pg. 150	969 Pg. 151	1858 Pg. 152
	DIN 376				1883 Pg. 151	1859 Pg. 152
Metric Fine	DIN 371					
	DIN 374			1009 Pg. 150	974 Pg. 151	1860 Pg. 152

Black Ring - Aluminum and Aluminum Alloys

Thread Depth		3 x Dia.	3 x Dia.	3 x Dia.	3 x Dia.	3 x Dia.
Flute Helix		Straight	Straight	Straight	Straight	Straight
Tool Substrate		HSS-E	HSS-E	HSS-E	CARBIDE	CARBIDE
Chamfer		3.5-5 "B"	3.5-5 "B"	3.5-5 "B"	2-3 "C"	2-3 "C"
Surface finish		○	● ^S	● ^M	○	○
Coolant		External	External	External	● Axial	● Radial
 Through Hole / Plug Taps						
Thread type	Blank Style	Tolerance Zone	Series Number			
UNC	ANSI	2B	3925 Pg. 156	3928 Pg. 158	3967 Pg. 160	
UNF			3926 Pg. 157	3929 Pg. 159	3968 Pg. 161	
Metric		6H	3924 Pg. 164	3927 Pg. 165	3966 Pg. 166	
UNC	DIN/ANSI	2BX				4118 Pg. 162
UNF						4119 Pg. 162
Metric	DIN 371	6HX				1858 Pg. 171
	DIN 376					1859 Pg. 171
Metric Fine	DIN 374					1860 Pg. 171

Black Ring - Aluminum and Aluminum Alloys

Thread Depth	3 x Dia.	3 x Dia.	3 x Dia.	3 x Dia.	3 x Dia.	3 x Dia.	3 x Dia.	3 x Dia.	3 x Dia.	
Flute Helix	45° Helix	45° Helix	45° Helix	Straight	Straight	Straight	Straight	15° Helix	Straight	
Tool Substrate	HSS-E	HSS-E	HSS-E	HSS-E	HSS-E-PM	HSS-E-PM	CARBIDE	CARBIDE	CARBIDE	
Chamfer	2-3 "C"	2-3 "C"	2-3 "C"	2-3 "C"	2-3 "C"	1.5-2 "E"	2-3 "C"	2-3 "C"	1.5-2 "E"	
Surface finish	●	● S	● M	● C	● C	● C	●	●	●	
Coolant	External	External	External	⦿ Axial	⦿ Axial	⦿ Axial	⦿ Axial	⦿ Axial	⦿ Axial	
 <p>Blind Hole / Bottoming Taps</p>										

Thread type	Blank Style	Tolerance Zone	Series Number							
UNC	ANSI	2B	3931 Pg. 156	3934 Pg. 158	3970 Pg. 160					
UNF			3932 Pg. 157	3935 Pg. 159	3971 Pg. 161					
Metric		6H	3930 Pg. 164	3933 Pg. 165	3969 Pg. 166					
UNC	DIN/ANSI	2BX				NEW 4394 Pg. 162		4118 Pg. 163		
UNF						NEW 4391 Pg. 162		4119 Pg. 163		
Metric	DIN 371	6HX				302 Pg. 167	1091 Pg. 168	969 Pg. 170	971 Pg. 172	1008 Pg. 169
	DIN 376				778 Pg. 173	297 Pg. 167	4165 Pg. 168	1883 Pg. 170		
	DIN 376 w/Ext. OAL				779 Pg. 173					
Metric Fine	DIN 371								977 Pg. 172	1009 Pg. 169
	DIN 374						1090 Pg. 167	1007 Pg. 168	974 Pg. 170	

Form Taps / Fluteless Tapping

Advantages to form tapping vs. conventional tapping:

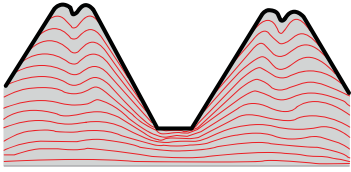

Form tap

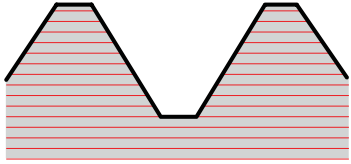



Conventional tap

- No chips to be evacuated or removed
- Reduced risk of breakage due to rigid design
- Increased tensile strength of the thread due to uninterrupted material structure
- Higher cutting speed
- Formed threads conform well to the gauge
- Good surface quality
- Large application range
 - through holes and blind holes = same tap
 - large variety of workable materials
- Longer tool life: 3 to 5 times the life of cut taps

		Thread Depth	3 x Dia.	3 x Dia.	3 x Dia.	3 x Dia.
		Flute Helix	Straight	Straight	Straight	Straight
		Tool Substrate	HSS-E	HSS-E	HSS-E	HSS-E-PM
		Chamfer	2-3 "C"	2-3 "C"	1.5-2 "E"	2-3 "C"
		Surface finish	S	C	S	C
		Coolant	External	External	External	External
<p>Blind Hole or Through Hole Straight Flute Taps</p>						
Thread type	Blank Style	Tolerance Zone	Series Number			
UNC	ANSI	2BX	3940 Pg. 180	3943 Pg. 181	3959 Pg. 184	
UNF			3941 Pg. 180	3944 Pg. 181	3972 Pg. 184	
Metric	ANSI	6HX	3939 Pg. 188	3942 Pg. 189	3979 Pg. 189	
Metric Fine			3975 Pg. 188			
UNC	DIN/ANSI	2BX			NEW 4377 Pg. 182	
UNF					NEW 4378 Pg. 182	
UNC	DIN 371	2BX	1582 Pg. 186			
	DIN 376		1583 Pg. 186			
UNF	DIN 371	2BX	1584 Pg. 187			
	DIN 374		1585 Pg. 187			
Metric	DIN 371	6HX	919 Pg. 190			
	DIN 376					
Metric MICRO	DIN 371	6HX	NEW 921 Pg. 191			
Metric Fine	DIN 374		927 Pg. 191			

Form Taps / Fluteless Tapping

			Thread Depth	3 x Dia.	3 x Dia.	3 x Dia.	3 x Dia.	3 x Dia.	3 x Dia.	3 x Dia.
			Flute Helix	Straight	Straight	Straight	Straight	Straight	Straight	Straight
			Tool Substrate	HSS-E	HSS-E-PM	HSS-E-PM	HSS-E-PM	HSS-E-PM	CARBIDE	CARBIDE
			Chamfer	2-3 "C"	2-3 "C"	2-3 "C"	2-3 "C"	1.5-2 "E"	2-3 "C"	1.5-2 "E"
			Surface finish	S	S	A	C	S	A	A
			Coolant	Axial	Radial	Radial	Radial	Axial	Radial	Radial
 <p>Blind Hole or Through Hole Straight Flute Taps</p>										
Thread type	Blank Style	Tolerance Zone	Series Number							
UNC	ANSI	2BX								
UNF										
Metric	ANSI	6HX								
Metric Fine										
UNC	DIN/ANSI	2BX				NEW 4379 Pg. 183	NEW 4383 Pg. 185			
UNF						NEW 4380 Pg. 183	NEW 4382 Pg. 185			
UNC	DIN 371	2BX								
	DIN 376									
UNF	DIN 371	2BX								
	DIN 374									
Metric	DIN 371	6HX		323 Pg. 192	1717 Pg. 192	1270 Pg. 192	1725 Pg. 196	1972 Pg. 198	1927 Pg. 198	
	DIN 376		NEW 923 Pg. 190	342 Pg. 193	1719 Pg. 193	1271 Pg. 193	1727 Pg. 196	1931 Pg. 198		
Metric Fine	DIN 371	6HX			1721 Pg. 194	1272 Pg. 194	1729 Pg. 197	1581 Pg. 199		
	DIN 374			338 Pg. 195	1723 Pg. 195	1273 Pg. 195	1731 Pg. 197	1581 Pg. 199		

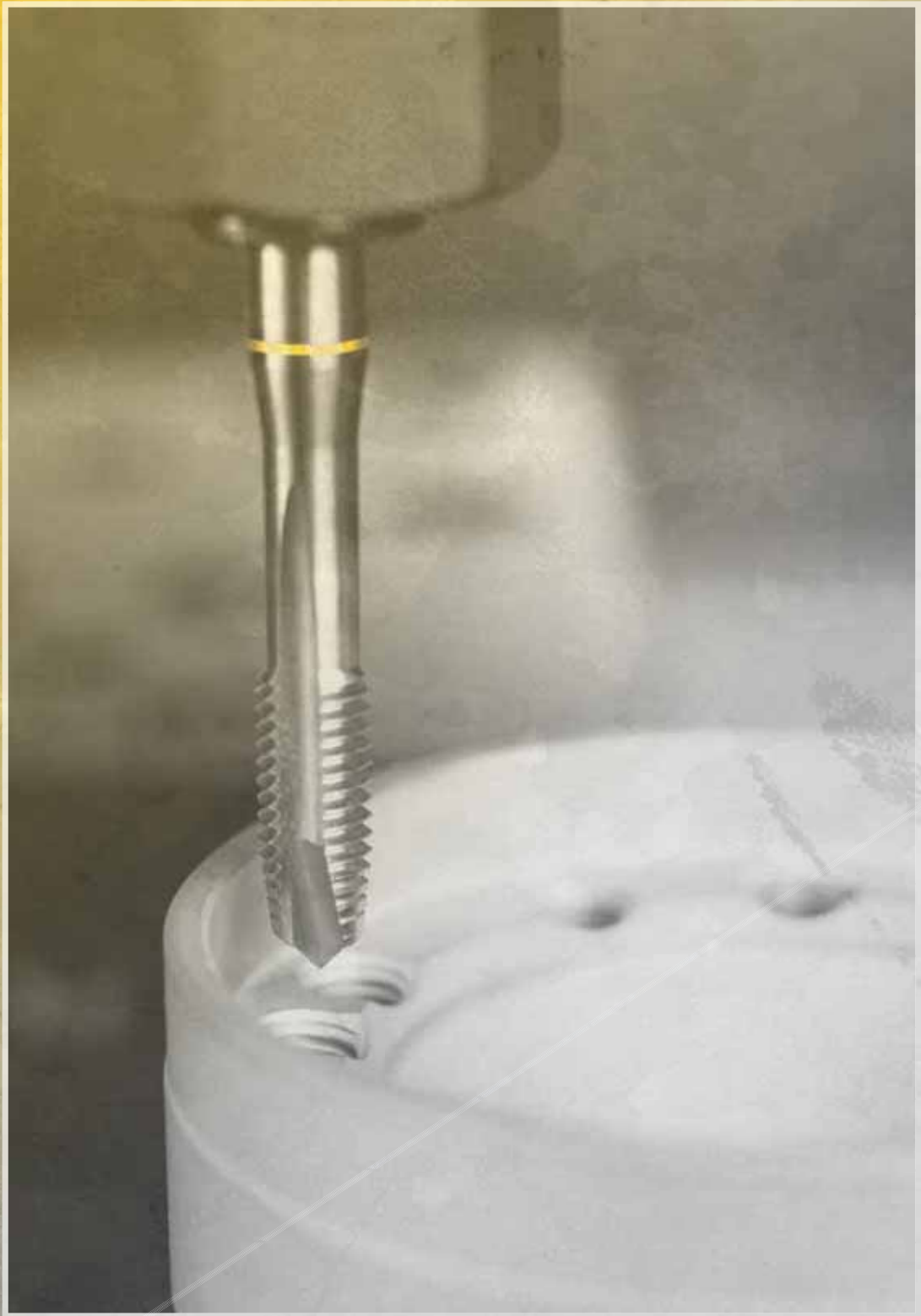

YELLOW RING CUT TAPS

Structural steels

Free-machining steels

Unalloyed case hardened steels

Unalloyed heat-treatable steels

Material group	Approximate Rc	Approximate HB	Recommended SFM			
			HSS-E		HSS-E-PM	
			bright finish	hard coated	bright finish	hard coated
Structural steels, free-cutting steels		<180	30-50	—	—	—
Unalloyed case hardened steels	<20	<230	20-40	—	—	—
Unalloyed heat-treatable steels	<25	<250	15-35	—	—	—

UNC

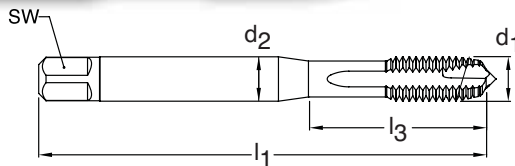

Series 3901
Standard ANSI
Tool Material HSS-E (Cobalt)
Spiral Point Straight flute
Chamfer Form B • 3.5 - 5
Class of Fit 2B

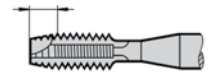

Through holes Bright Finish External cooling

d1 - P	H Limits	Tap Drill Range inch	Number of Flutes	d2 inch	SW inch	l1 inch	l3 inch	Order Code	EDP Number	Stock
4-40	H2/H3	0.085 - 0.094	3	0.141	0.110	1.882	0.709	2.845	9039010028450	●
5-40	H2/H3	0.098 - 0.106	3	0.141	0.110	1.941	0.709	3.175	9039010031750	●
6-32	H3/H4	0.104 - 0.114	3	0.141	0.110	2.000	0.748	3.505	9039010035050	●
8-32	H3/H4	0.130 - 0.139	3	0.168	0.131	2.130	0.827	4.166	9039010041660	●
10-24	H3/H4	0.145 - 0.155	3	0.194	0.152	2.382	0.945	4.826	9039010048260	●
12-24	H3/H4	0.171 - 0.181	3	0.220	0.165	2.382	1.024	5.486	9039010054860	●
1/4-20	H4/H5	0.196 - 0.207	3	0.255	0.191	2.500	1.181	6.350	9039010063500	●
5/16-18	H4/H5	0.252 - 0.265	3	0.318	0.238	2.721	1.377	7.938	9039010079380	●
3/8-16	H5/H6	0.307 - 0.321	3	0.381	0.286	2.941	1.456	9.525	9039010095250	●
7/16-14	H5/H6	0.360 - 0.376	3	0.323	0.242	3.161	N/A	11.113	9039010111130	●
1/2-13	H5/H6	0.417 - 0.434	3	0.367	0.275	3.382	N/A	12.700	9039010127000	●
9/16-12	H5/H6	0.472 - 0.490	3	0.429	0.322	3.591	N/A	14.288	9039010142880	●
5/8-11	H5/H6	0.527 - 0.546	3	0.480	0.360	3.811	N/A	15.875	9039010158750	●
3/4-10	H5/H6	0.642 - 0.663	4	0.590	0.442	4.252	N/A	19.050	9039010190500	●
7/8-9	H6/H7	0.755 - 0.778	4	0.697	0.523	4.689	N/A	22.225	9039010222250	●
1-8	H6/H7	0.865 - 0.890	4	0.800	0.600	5.130	N/A	25.400	9039010254000	●

UNC

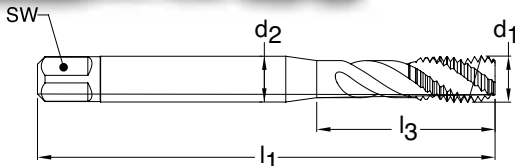

Series 3904
Standard ANSI
Tool Material HSS-E (Cobalt)
Spiral Flute 40° Helix
Chamfer Form C • 2-3
Class of Fit 2B

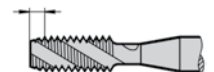

Blind holes Bright finish External cooling

d1 - P	H Limits	Tap Drill Range inch	Number of Flutes	d2 inch	SW inch	l1 inch	l3 inch	Order Code	EDP Number	Stock
4-40	H2/H3	0.085 - 0.094	3	0.141	0.110	1.882	0.709	2.845	9039040028450	●
5-40	H2/H3	0.098 - 0.106	3	0.141	0.110	1.941	0.709	3.175	9039040031750	●
6-32	H3/H4	0.104 - 0.114	3	0.141	0.110	2.000	0.748	3.505	9039040035050	●
8-32	H3/H4	0.130 - 0.139	3	0.168	0.131	2.130	0.827	4.166	9039040041660	●
10-24	H3/H4	0.145 - 0.155	3	0.194	0.152	2.382	0.945	4.826	9039040048260	●
12-24	H3/H4	0.171 - 0.181	3	0.220	0.165	2.382	1.024	5.486	9039040054860	●
1/4-20	H4/H5	0.196 - 0.207	3	0.255	0.191	2.500	1.181	6.350	9039040063500	●
5/16-18	H4/H5	0.252 - 0.265	3	0.318	0.238	2.721	1.377	7.938	9039040079380	●
3/8-16	H5/H6	0.307 - 0.321	3	0.381	0.286	2.941	1.456	9.525	9039040095250	●
7/16-14	H5/H6	0.360 - 0.376	3	0.323	0.242	3.161	N/A	11.113	9039040111130	●
1/2-13	H5/H6	0.417 - 0.434	3	0.367	0.275	3.382	N/A	12.700	9039040127000	●
9/16-12	H5/H6	0.472 - 0.490	3	0.429	0.322	3.591	N/A	14.288	9039040142880	●
5/8-11	H5/H6	0.527 - 0.546	3	0.480	0.360	3.811	N/A	15.875	9039040158750	●
3/4-10	H5/H6	0.642 - 0.663	4	0.590	0.442	4.252	N/A	19.050	9039040190500	●
7/8-9	H6/H7	0.755 - 0.778	4	0.697	0.523	4.689	N/A	22.225	9039040222250	●
1-8	H6/H7	0.865 - 0.890	4	0.800	0.600	5.130	N/A	25.400	9039040254000	●

UNF

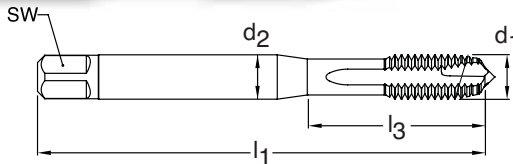

Series 3902
Standard ANSI
Tool Material HSS-E (Cobalt)
Spiral Point Straight flute
Chamfer Form B • 3.5 - 5
Class of Fit 2B



Through holes **Bright finish** **External cooling**

d1 - P	H Limits	Tap Drill Range inch	Number of Flutes	d2 inch	SW inch	l1 inch	l3 inch	Order Code	EDP Number	Stock
4-48	H2/H3	0.089 - 0.097	3	0.141	0.110	1.882	0.709	2.845	9039020028450	●
5-44	H2/H3	0.100 - 0.108	3	0.141	0.110	1.941	0.709	3.175	9039020031750	●
6-40	H2/H3	0.111 - 0.119	3	0.141	0.110	2.000	0.748	3.505	9039020035050	●
8-36	H2/H3	0.134 - 0.142	3	0.168	0.131	2.130	0.827	4.166	9039020041660	●
10-32	H3/H4	0.156 - 0.164	3	0.194	0.152	2.382	0.945	4.826	9039020048260	●
12-28	H3/H4	0.177 - 0.186	3	0.220	0.165	2.382	1.024	5.486	9039020054860	●
1/4-28	H3/H4	0.211 - 0.220	3	0.255	0.191	2.500	1.181	6.350	9039020063500	●
5/16-24	H3/H4	0.267 - 0.277	3	0.318	0.238	2.721	1.377	7.938	9039020079380	●
3/8-24	H3/H4	0.330 - 0.340	3	0.381	0.286	2.941	1.456	9.525	9039020095250	●
7/16-20	H4/H5	0.383 - 0.395	3	0.323	0.242	3.161	N/A	11.113	9039020111130	●
1/2-20	H4/H5	0.446 - 0.457	3	0.367	0.275	3.382	N/A	12.700	9039020127000	●
9/16-18	H4/H5	0.502 - 0.515	3	0.429	0.322	3.591	N/A	14.288	9039020142880	●
5/8-18	H4/H5	0.565 - 0.578	3	0.480	0.360	3.811	N/A	15.875	9039020158750	●
3/4-16	H5/H6	0.682 - 0.696	4	0.590	0.442	4.252	N/A	19.050	9039020190500	●
7/8-14	H6/H7	0.798 - 0.813	4	0.697	0.523	4.689	N/A	22.225	9039020222250	●
1-12	H6/H7	0.910 - 0.928	4	0.800	0.600	5.130	N/A	25.400	9039020254000	●

UNF

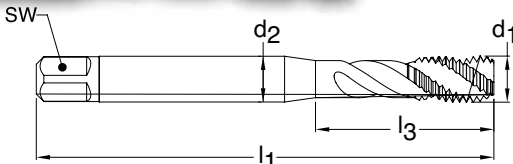

Series 3905
Standard ANSI
Tool Material HSS-E (Cobalt)
Spiral Flute 40° Helix
Chamfer Form C • 2-3
Class of Fit 2B

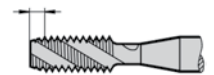

Blind holes **Bright finish** **External cooling**

d1 - P	H Limits	Tap Drill Range inch	Number of Flutes	d2 inch	SW inch	l1 inch	l3 inch	Order Code	EDP Number	Stock
4-48	H2/H3	0.089 - 0.097	3	0.141	0.110	1.882	0.709	2.845	9039050028450	●
5-44	H2/H3	0.100 - 0.108	3	0.141	0.110	1.941	0.709	3.175	9039050031750	●
6-40	H2/H3	0.111 - 0.119	3	0.141	0.110	2.000	0.748	3.505	9039050035050	●
8-36	H2/H3	0.134 - 0.142	3	0.168	0.131	2.130	0.827	4.166	9039050041660	●
10-32	H3/H4	0.156 - 0.164	3	0.194	0.152	2.382	0.945	4.826	9039050048260	●
12-28	H3/H4	0.177 - 0.186	3	0.220	0.165	2.382	1.024	5.486	9039050054860	●
1/4-28	H3/H4	0.211 - 0.220	3	0.255	0.191	2.500	1.181	6.350	9039050063500	●
5/16-24	H3/H4	0.267 - 0.277	3	0.318	0.238	2.721	1.377	7.938	9039050079380	●
3/8-24	H3/H4	0.330 - 0.340	3	0.381	0.286	2.941	1.456	9.525	9039050095250	●
7/16-20	H4/H5	0.383 - 0.395	3	0.323	0.242	3.161	N/A	11.113	9039050111130	●
1/2-20	H4/H5	0.446 - 0.457	3	0.367	0.275	3.382	N/A	12.700	9039050127000	●
9/16-18	H4/H5	0.502 - 0.515	3	0.429	0.322	3.591	N/A	14.288	9039050142880	●
5/8-18	H4/H5	0.565 - 0.578	3	0.480	0.360	3.811	N/A	15.875	9039050158750	●
3/4-16	H5/H6	0.682 - 0.696	4	0.590	0.442	4.252	N/A	19.050	9039050190500	●
7/8-14	H6/H7	0.798 - 0.813	4	0.697	0.523	4.689	N/A	22.225	9039050222250	●
1-12	H6/H7	0.910 - 0.928	4	0.800	0.600	5.130	N/A	25.400	9039050254000	●

"Tap drill Range" given is per the Class of Fit shown per Series #
 Additional Tap Drill sizes & percent of thread engagement can be found on pages 229-237

UNC



Series 3961
Standard ANSI
Tool Material HSS-E (Cobalt)
Spiral Point Straight flute
Chamfer Form B • 3.5 - 5
Class of Fit 2B

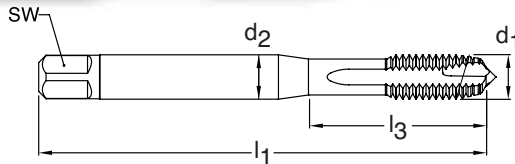

Through holes **MolyGlide®** **External cooling**

d1 - P	H Limits	Tap Drill Range inch	Number of Flutes	d2 inch	SW inch	l1 inch	l3 inch	Order Code	EDP Number	Stock
4-40	H2/H3	0.085 - 0.094	3	0.141	0.110	1.882	0.709	2.845	9039610028450	●
5-40	H2/H3	0.098 - 0.106	3	0.141	0.110	1.941	0.709	3.175	9039610031750	●
6-32	H3/H4	0.104 - 0.114	3	0.141	0.110	2.000	0.748	3.505	9039610035050	●
8-32	H3/H4	0.130 - 0.139	3	0.168	0.131	2.130	0.827	4.166	9039610041660	●
10-24	H3/H4	0.145 - 0.155	3	0.194	0.152	2.382	0.945	4.826	9039610048260	●
12-24	H3/H4	0.171 - 0.181	3	0.220	0.165	2.382	1.024	5.486	9039610054860	●
1/4-20	H4/H5	0.196 - 0.207	3	0.255	0.191	2.500	1.181	6.350	9039610063500	●
5/16-18	H4/H5	0.252 - 0.265	3	0.318	0.238	2.721	1.377	7.938	9039610079380	●
3/8-16	H5/H6	0.307 - 0.321	3	0.381	0.286	2.941	1.456	9.525	9039610095250	●
7/16-14	H5/H6	0.360 - 0.376	3	0.323	0.242	3.161	N/A	11.113	9039610111130	●
1/2-13	H5/H6	0.417 - 0.434	3	0.367	0.275	3.382	N/A	12.700	9039610127000	●
9/16-12	H5/H6	0.472 - 0.490	3	0.429	0.322	3.591	N/A	14.288	9039610142880	●
5/8-11	H5/H6	0.527 - 0.546	3	0.480	0.360	3.811	N/A	15.875	9039610158750	●
3/4-10	H5/H6	0.642 - 0.663	4	0.590	0.442	4.252	N/A	19.050	9039610190500	●
7/8-9	H6/H7	0.755 - 0.778	4	0.697	0.523	4.689	N/A	22.225	9039610222250	●
1-8	H6/H7	0.865 - 0.890	4	0.800	0.600	5.130	N/A	25.400	9039610254000	●

UNC



Series 3964
Standard ANSI
Tool Material HSS-E (Cobalt)
Spiral Flute 40° Helix
Chamfer Form C • 2-3
Class of Fit 2B

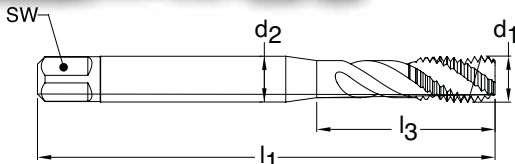
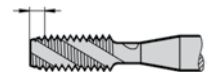

Blind holes **MolyGlide®** **External cooling**

d1 - P	H Limits	Tap Drill Range inch	Number of Flutes	d2 inch	SW inch	l1 inch	l3 inch	Order Code	EDP Number	Stock
4-40	H2/H3	0.085 - 0.094	3	0.141	0.110	1.882	0.709	2.845	9039640028450	●
5-40	H2/H3	0.098 - 0.106	3	0.141	0.110	1.941	0.709	3.175	9039640031750	●
6-32	H3/H4	0.104 - 0.114	3	0.141	0.110	2.000	0.748	3.505	9039640035050	●
8-32	H3/H4	0.130 - 0.139	3	0.168	0.131	2.130	0.827	4.166	9039640041660	●
10-24	H3/H4	0.145 - 0.155	3	0.194	0.152	2.382	0.945	4.826	9039640048260	●
12-24	H3/H4	0.171 - 0.181	3	0.220	0.165	2.382	1.024	5.486	9039640054860	●
1/4-20	H4/H5	0.196 - 0.207	3	0.255	0.191	2.500	1.181	6.350	9039640063500	●
5/16-18	H4/H5	0.252 - 0.265	3	0.318	0.238	2.721	1.377	7.938	9039640079380	●
3/8-16	H5/H6	0.307 - 0.321	3	0.381	0.286	2.941	1.456	9.525	9039640095250	●
7/16-14	H5/H6	0.360 - 0.376	3	0.323	0.242	3.161	N/A	11.113	9039640111130	●
1/2-13	H5/H6	0.417 - 0.434	3	0.367	0.275	3.382	N/A	12.700	9039640127000	●
9/16-12	H5/H6	0.472 - 0.490	3	0.429	0.322	3.591	N/A	14.288	9039640142880	●
5/8-11	H5/H6	0.527 - 0.546	3	0.480	0.360	3.811	N/A	15.875	9039640158750	●
3/4-10	H5/H6	0.642 - 0.663	4	0.590	0.442	4.252	N/A	19.050	9039640190500	●
7/8-9	H6/H7	0.755 - 0.778	4	0.697	0.523	4.689	N/A	22.225	9039640222250	●
1-8	H6/H7	0.865 - 0.890	4	0.800	0.600	5.130	N/A	25.400	9039640254000	●

UNF

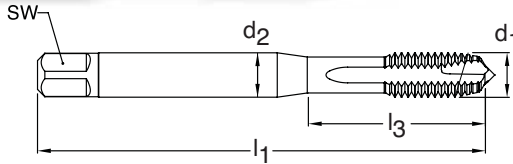

Series 3962
Standard ANSI
Tool Material HSS-E (Cobalt)
Spiral Point Straight flute
Chamfer Form B • 3.5 - 5
Class of Fit 2B



Through holes **MolyGlide®** **External cooling**

d1 - P	H Limits	Tap Drill Range inch	Number of Flutes	d2 inch	SW inch	l1 inch	l3 inch	Order Code	EDP Number	Stock
4-48	H2/H3	0.089 - 0.097	3	0.141	0.110	1.882	0.709	2.845	9039620028450	●
5-44	H2/H3	0.100 - 0.108	3	0.141	0.110	1.941	0.709	3.175	9039620031750	●
6-40	H2/H3	0.111 - 0.119	3	0.141	0.110	2.000	0.748	3.505	9039620035050	●
8-36	H2/H3	0.134 - 0.142	3	0.168	0.131	2.130	0.827	4.166	9039620041660	●
10-32	H3/H4	0.156 - 0.164	3	0.194	0.152	2.382	0.945	4.826	9039620048260	●
12-28	H3/H4	0.177 - 0.186	3	0.220	0.165	2.382	1.024	5.486	9039620054860	●
1/4-28	H3/H4	0.211 - 0.220	3	0.255	0.191	2.500	1.181	6.350	9039620063500	●
5/16-24	H3/H4	0.267 - 0.277	3	0.318	0.238	2.721	1.377	7.938	9039620079380	●
3/8-24	H3/H4	0.330 - 0.340	3	0.381	0.286	2.941	1.456	9.525	9039620095250	●
7/16-20	H4/H5	0.383 - 0.395	3	0.323	0.242	3.161	N/A	11.113	9039620111130	●
1/2-20	H4/H5	0.446 - 0.457	3	0.367	0.275	3.382	N/A	12.700	9039620127000	●
9/16-18	H4/H5	0.502 - 0.515	3	0.429	0.322	3.591	N/A	14.288	9039620142880	●
5/8-18	H4/H5	0.565 - 0.578	3	0.480	0.360	3.811	N/A	15.875	9039620158750	●
3/4-16	H5/H6	0.682 - 0.696	4	0.590	0.442	4.252	N/A	19.050	9039620190500	●
7/8-14	H6/H7	0.798 - 0.813	4	0.697	0.523	4.689	N/A	22.225	9039620222250	●
1-12	H6/H7	0.910 - 0.928	4	0.800	0.600	5.130	N/A	25.400	9039620254000	●

UNF

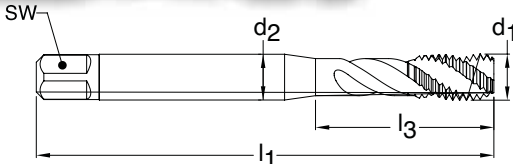

Series 3965
Standard ANSI
Tool Material HSS-E (Cobalt)
Spiral Flute 40° Helix
Chamfer Form C • 2-3
Class of Fit 2B

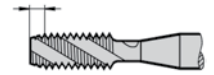

Blind holes **MolyGlide®** **External cooling**

d1 - P	H Limits	Tap Drill Range inch	Number of Flutes	d2 inch	SW inch	l1 inch	l3 inch	Order Code	EDP Number	Stock
4-48	H2/H3	0.089 - 0.097	3	0.141	0.110	1.882	0.709	2.845	9039650028450	●
5-44	H2/H3	0.100 - 0.108	3	0.141	0.110	1.941	0.709	3.175	9039650031750	●
6-40	H2/H3	0.111 - 0.119	3	0.141	0.110	2.000	0.748	3.505	9039650035050	●
8-36	H2/H3	0.134 - 0.142	3	0.168	0.131	2.130	0.827	4.166	9039650041660	●
10-32	H3/H4	0.156 - 0.164	3	0.194	0.152	2.382	0.945	4.826	9039650048260	●
12-28	H3/H4	0.177 - 0.186	3	0.220	0.165	2.382	1.024	5.486	9039650054860	●
1/4-28	H3/H4	0.211 - 0.220	3	0.255	0.191	2.500	1.181	6.350	9039650063500	●
5/16-24	H3/H4	0.267 - 0.277	3	0.318	0.238	2.721	1.377	7.938	9039650079380	●
3/8-24	H3/H4	0.330 - 0.340	3	0.381	0.286	2.941	1.456	9.525	9039650095250	●
7/16-20	H4/H5	0.383 - 0.395	3	0.323	0.242	3.161	N/A	11.113	9039650111130	●
1/2-20	H4/H5	0.446 - 0.457	3	0.367	0.275	3.382	N/A	12.700	9039650127000	●
9/16-18	H4/H5	0.502 - 0.515	3	0.429	0.322	3.591	N/A	14.288	9039650142880	●
5/8-18	H4/H5	0.565 - 0.578	3	0.480	0.360	3.811	N/A	15.875	9039650158750	●
3/4-16	H5/H6	0.682 - 0.696	4	0.590	0.442	4.252	N/A	19.050	9039650190500	●
7/8-14	H6/H7	0.798 - 0.813	4	0.697	0.523	4.689	N/A	22.225	9039650222250	●
1-12	H6/H7	0.910 - 0.928	4	0.800	0.600	5.130	N/A	25.400	9039650254000	●

"Tap drill Range" given is per the Class of Fit shown per Series #
 Additional Tap Drill sizes & percent of thread engagement can be found on pages 229-237

METRIC



Series 3900
Standard ANSI
Tool Material HSS-E (Cobalt)
Spiral Point Straight flute
Chamfer Form B • 3.5 - 5
Class of Fit ISO 2(6H)

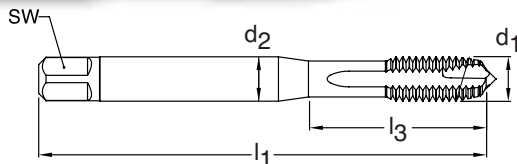
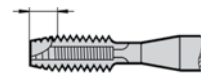

Through holes **Bright finish** **External cooling**

d1 - P	D Limits	Tap Drill Range mm	Number of Flutes	d2 inch	SW inch	l1 inch	l3 inch	Order Code	EDP Number	Stock
M2 X 0.40	D2/D3	1.567 - 1.679	3	0.141	0.110	1.752	0.441	2.000	9039000020000	●
M3 X 0.50	D2/D3	2.459 - 2.599	3	0.141	0.110	1.941	0.709	3.000	9039000030000	●
M4 X 0.70	D3/D4	3.242 - 3.422	3	0.168	0.131	2.130	0.827	4.000	9039000040000	●
M5 X 0.80	D3/D4	4.134 - 4.334	3	0.194	0.152	2.382	0.945	5.000	9039000050000	●
M6 X 1.00	D4/D5	4.917 - 5.153	3	0.255	0.191	2.500	1.181	6.000	9039000060000	●
M8 X 1.25	D4/D5	6.647 - 6.912	3	0.318	0.238	2.721	1.377	8.000	9039000080000	●
M10 X 1.50	D4/D5	8.376 - 8.676	3	0.381	0.286	2.941	1.456	10.000	9039000100000	●
M12 X 1.75	D5/D6	10.106 - 10.441	3	0.367	0.275	3.382	N/A	12.000	9039000120000	●
M14 X 2.00	D5/D6	11.835 - 12.210	3	0.429	0.322	3.591	N/A	14.000	9039000140000	●
M16 X 2.00	D6/D7	13.835 - 14.210	3	0.480	0.360	3.811	N/A	16.000	9039000160000	●
M18 X 2.50	D6/D7	15.294 - 15.744	4	0.542	0.406	4.032	N/A	18.000	9039000180000	●
M20 X 2.50	D6/D7	17.294 - 17.744	4	0.652	0.489	4.469	N/A	20.000	9039000200000	●

METRIC



Series 3903
Standard ANSI
Tool Material HSS-E (Cobalt)
Spiral Flute 40° Helix
Chamfer Form C • 2-3
Class of Fit ISO 2(6H)

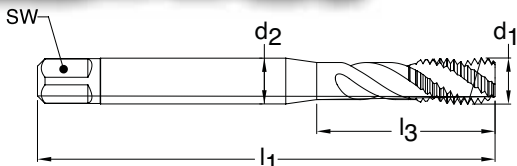

Blind holes **Bright finish** **External cooling**

d1 - P	D Limits	Tap Drill Range mm	Number of Flutes	d2 inch	SW inch	l1 inch	l3 inch	Order Code	EDP Number	Stock
M2 X 0.40	D2/D3	1.567 - 1.679	3	0.141	0.110	1.752	0.441	2.000	9039030020000	●
M3 X 0.50	D2/D3	2.459 - 2.599	3	0.141	0.110	1.941	0.709	3.000	9039030030000	●
M4 X 0.70	D3/D4	3.242 - 3.422	3	0.168	0.131	2.130	0.827	4.000	9039030040000	●
M5 X 0.80	D3/D4	4.134 - 4.334	3	0.194	0.152	2.382	0.945	5.000	9039030050000	●
M6 X 1.00	D4/D5	4.917 - 5.153	3	0.255	0.191	2.500	1.181	6.000	9039030060000	●
M8 X 1.25	D4/D5	6.647 - 6.912	3	0.318	0.238	2.721	1.377	8.000	9039030080000	●
M10 X 1.50	D4/D5	8.376 - 8.676	3	0.381	0.286	2.941	1.456	10.000	9039030100000	●
M12 X 1.75	D5/D6	10.106 - 10.441	3	0.367	0.275	3.382	N/A	12.000	9039030120000	●
M14 X 2.00	D5/D6	11.835 - 12.210	3	0.429	0.322	3.591	N/A	14.000	9039030140000	●
M16 X 2.00	D6/D7	13.835 - 14.210	3	0.480	0.360	3.811	N/A	16.000	9039030160000	●
M18 X 2.50	D6/D7	15.294 - 15.744	4	0.542	0.406	4.032	N/A	18.000	9039030180000	●
M20 X 2.50	D6/D7	17.294 - 17.744	4	0.652	0.489	4.469	N/A	20.000	9039030200000	●

METRIC



Series 3960
Standard ANSI
Tool Material HSS-E (Cobalt)
Spiral Point Straight flute
Chamfer Form B • 3.5 - 5
Class of Fit ISO 2(6H)

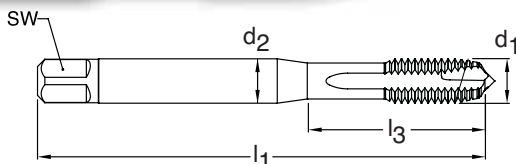
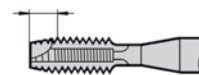

Through holes



MolyGlide®



External cooling

d1 - P	D Limits	Tap Drill Range mm	Number of Flutes	d2 inch	SW inch	l1 inch	l3 inch	Order Code	EDP Number	Stock
M2 X 0.40	D2/D3	1.567 - 1.679	3	0.141	0.110	1.752	0.441	2.000	9039600020000	●
M3 X 0.50	D2/D3	2.459 - 2.599	3	0.141	0.110	1.941	0.709	3.000	9039600030000	●
M4 X 0.70	D3/D4	3.242 - 3.422	3	0.168	0.131	2.130	0.827	4.000	9039600040000	●
M5 X 0.80	D3/D4	4.134 - 4.334	3	0.194	0.152	2.382	0.945	5.000	9039600050000	●
M6 X 1.00	D4/D5	4.917 - 5.153	3	0.255	0.191	2.500	1.181	6.000	9039600060000	●
M8 X 1.25	D4/D5	6.647 - 6.912	3	0.318	0.238	2.721	1.377	8.000	9039600080000	●
M10 X 1.50	D4/D5	8.376 - 8.676	3	0.381	0.286	2.941	1.456	10.000	9039600100000	●
M12 X 1.75	D5/D6	10.106 - 10.441	3	0.367	0.275	3.382	N/A	12.000	9039600120000	●
M14 X 2.00	D5/D6	11.835 - 12.210	3	0.429	0.322	3.591	N/A	14.000	9039600140000	●
M16 X 2.00	D6/D7	13.835 - 14.210	3	0.480	0.360	3.811	N/A	16.000	9039600160000	●
M18 X 2.50	D6/D7	15.294 - 15.744	4	0.542	0.406	4.032	N/A	18.000	9039600180000	●
M20 X 2.50	D6/D7	17.294 - 17.744	4	0.652	0.489	4.469	N/A	20.000	9039600200000	●

METRIC



Series 3963
Standard ANSI
Tool Material HSS-E (Cobalt)
Spiral Flute 40° Helix
Chamfer Form C • 2-3
Class of Fit ISO 2(6H)

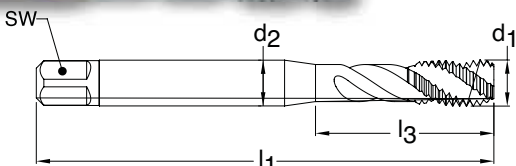

Blind holes



MolyGlide®



External cooling

d1 - P	D Limits	Tap Drill Range mm	Number of Flutes	d2 inch	SW inch	l1 inch	l3 inch	Order Code	EDP Number	Stock
M2 X 0.40	D2/D3	1.567 - 1.679	3	0.141	0.110	1.752	0.441	2.000	9039630020000	●
M3 X 0.50	D2/D3	2.459 - 2.599	3	0.141	0.110	1.941	0.709	3.000	9039630030000	●
M4 X 0.70	D3/D4	3.242 - 3.422	3	0.168	0.131	2.130	0.827	4.000	9039630040000	●
M5 X 0.80	D3/D4	4.134 - 4.334	3	0.194	0.152	2.382	0.945	5.000	9039630050000	●
M6 X 1.00	D4/D5	4.917 - 5.153	3	0.255	0.191	2.500	1.181	6.000	9039630060000	●
M8 X 1.25	D4/D5	6.647 - 6.912	3	0.318	0.238	2.721	1.377	8.000	9039630080000	●
M10 X 1.50	D4/D5	8.376 - 8.676	3	0.381	0.286	2.941	1.456	10.000	9039630100000	●
M12 X 1.75	D5/D6	10.106 - 10.441	3	0.367	0.275	3.382	N/A	12.000	9039630120000	●
M14 X 2.00	D5/D6	11.835 - 12.210	3	0.429	0.322	3.591	N/A	14.000	9039630140000	●
M16 X 2.00	D6/D7	13.835 - 14.210	3	0.480	0.360	3.811	N/A	16.000	9039630160000	●
M18 X 2.50	D6/D7	15.294 - 15.744	4	0.542	0.406	4.032	N/A	18.000	9039630180000	●
M20 X 2.50	D6/D7	17.294 - 17.744	4	0.652	0.489	4.469	N/A	20.000	9039630200000	●

"Tap drill Range" given is per the Class of Fit shown per Series #
 Additional Tap Drill sizes & percent of thread engagement can be found on pages 229-237

METRIC

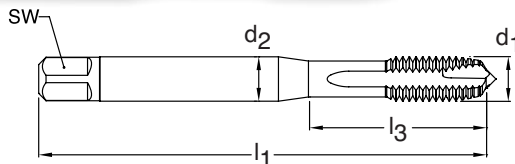

Series 803
Standard DIN 371
Tool Material HSS-E (Cobalt)
Spiral Point Straight flute
Chamfer Form B • 3.5 - 5
Class of Fit ISO 2(6H)

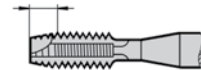

Through holes **Bright finish** **External cooling**

d1 - P	D Limits	Tap Drill Range mm	Number of Flutes	d2 mm	SW mm	l1 mm	l3 mm	Order Code	EDP Number	Stock
M1.4 X 0.30	D2/D3	1.075 - 1.142	2	2.50	2.10	40.00	7.00	1.400	9008030014000	●
M1.6 X 0.35	D2/D3	1.221 - 1.321	2	2.50	2.10	40.00	8.00	1.600	9008030016000	○
M1.7 X 0.35	D2/D3	1.530 - 1.570	2	2.50	2.10	40.00	8.00	1.700	9008030017000	●
M1.8 X 0.35	D2/D3	1.421 - 1.521	2	2.50	2.10	40.00	8.00	1.800	9008030018000	○
M2 X 0.40	D2/D3	1.567 - 1.679	3	2.80	2.10	45.00	13.50	2.000	9008030020000	●
M2.2 X 0.45	D2/D3	1.713 - 1.838	3	2.80	2.10	45.00	14.50	2.200	9008030022000	○
M2.3 X 0.40	D2/D3	1.870 - 1.980	3	2.80	2.10	45.00	14.50	2.300	9008030023000	○
M2.5 X 0.45	D2/D3	2.013 - 2.138	3	2.80	2.10	50.00	14.50	2.500	9008030025000	●
M2.6 X 0.45	D2/D3	2.110 - 2.240	3	2.80	2.10	50.00	14.50	2.600	9008030026000	○
M3 X 0.50	D2/D3	2.459 - 2.599	3	3.50	2.70	56.00	18.00	3.000	9008030030000	○
M3.5 X 0.60	D3/D4	2.850 - 3.010	3	4.00	3.00	56.00	20.00	3.500	9008030035000	●
M4 X 0.70	D3/D4	3.242 - 3.422	3	4.50	3.40	63.00	21.00	4.000	9008030040000	●
M5 X 0.80	D3/D4	4.134 - 4.334	3	6.00	4.90	70.00	25.00	5.000	9008030050000	●
M6 X 1.00	D4/D5	4.917 - 5.153	3	6.00	4.90	80.00	30.00	6.000	9008030060000	●
M7 X 1.00	D4/D5	5.917 - 6.153	3	7.00	5.50	80.00	30.00	7.000	9008030070000	●
M8 X 1.25	D4/D5	6.647 - 6.912	3	8.00	6.20	90.00	35.00	8.000	9008030080000	●
M10 X 1.50	D4/D5	8.376 - 8.676	3	10.00	8.00	100.00	39.00	10.000	9008030100000	●

METRIC

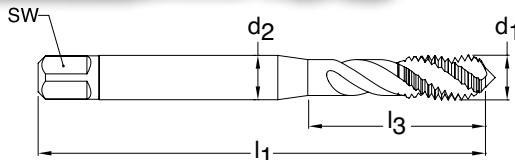

Series 810
Standard DIN 371
Tool Material HSS-E (Cobalt)
Spiral Flute 40° Helix
Chamfer Form C • 2-3
Class of Fit ISO 2(6H)



Blind holes **Bright finish** **External cooling**

d1 - P	D Limits	Tap Drill Range mm	Number of Flutes	d2 mm	SW mm	l1 mm	l3 mm	Order Code	EDP Number	Stock
M2 X 0.40	D2/D3	1.567 - 1.679	3	2.80	2.10	45.00	13.50	2.000	9008100020000	●
M2.2 X 0.45	D2/D3	1.713 - 1.838	3	2.80	2.10	45.00	14.50	2.200	9008100022000	●
M2.3 X 0.40	D2/D3	1.870 - 1.980	3	2.80	2.10	45.00	14.50	2.300	9008100023000	○
M2.5 X 0.45	D2/D3	2.013 - 2.138	3	2.80	2.10	50.00	14.50	2.500	9008100025000	●
M3 X 0.50	D2/D3	2.459 - 2.599	3	3.50	2.70	56.00	18.00	3.000	9008100030000	○
M3.5 X 0.60	D3/D4	2.850 - 3.010	3	4.00	3.00	56.00	20.00	3.500	9008100035000	●
M4 X 0.70	D3/D4	3.242 - 3.422	3	4.50	3.40	63.00	21.00	4.000	9008100040000	●
M5 X 0.80	D3/D4	4.134 - 4.334	3	6.00	4.90	70.00	25.00	5.000	9008100050000	●
M6 X 1.00	D4/D5	4.917 - 5.153	3	6.00	4.90	80.00	30.00	6.000	9008100060000	●
M8 X 1.25	D4/D5	6.647 - 6.912	3	8.00	6.20	90.00	35.00	8.000	9008100080000	●
M10 X 1.50	D4/D5	8.376 - 8.676	3	10.00	8.00	100.00	39.00	10.000	9008100100000	●

METRIC

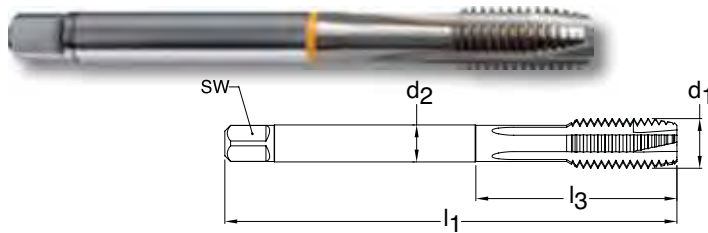

Series 815
Standard DIN 376
Tool Material HSS-E (Cobalt)
Spiral Point Straight flute
Chamfer Form B • 3.5 - 5
Class of Fit ISO 2(6H)



Through holes

Bright finish

External cooling

d1 - P	D Limits	Tap Drill Range mm	Number of Flutes	d2 mm	SW mm	l1 mm	l3 mm	Order Code	EDP Number	Stock
M1.6 X 0.35	D2/D3	1.221 - 1.321	2	1.20	N/A	40.00	N/A	1.600	9008150016000	○
M1.8 X 0.35	D2/D3	1.421 - 1.521	2	1.20	N/A	40.00	N/A	1.800	9008150018000	○
M2 X 0.40	D2/D3	1.567 - 1.679	3	1.40	N/A	45.00	N/A	2.000	9008150020000	○
M2.5 X 0.45	D2/D3	2.013 - 2.138	3	1.80	N/A	50.00	N/A	2.500	9008150025000	●
M2.6 X 0.45	D2/D3	2.110 - 2.240	3	1.80	N/A	50.00	N/A	2.600	9008150026000	○
M3 X 0.50	D2/D3	2.459 - 2.599	3	2.20	N/A	56.00	N/A	3.000	9008150030000	●
M3.5 X 0.60	D3/D4	2.850 - 3.010	3	2.50	2.10	56.00	N/A	3.500	9008150035000	●
M4 X 0.70	D3/D4	3.242 - 3.422	3	2.80	2.10	63.00	N/A	4.000	9008150040000	●
M5 X 0.80	D3/D4	4.134 - 4.334	3	3.50	2.70	70.00	N/A	5.000	9008150050000	●
M6 X 1.00	D4/D5	4.917 - 5.153	3	4.50	3.40	80.00	N/A	6.000	9008150060000	●
M7 X 1.00	D4/D5	5.917 - 6.153	3	5.50	4.30	80.00	N/A	7.000	9008150070000	●
M8 X 1.25	D4/D5	6.647 - 6.912	3	6.00	4.90	90.00	N/A	8.000	9008150080000	●
M10 X 1.50	D4/D5	8.376 - 8.676	3	7.00	5.50	100.00	N/A	10.000	9008150100000	●
M12 X 1.75	D5/D6	10.106 - 10.441	3	9.00	7.00	110.00	N/A	12.000	9008150120000	●
M14 X 2.00	D5/D6	11.835 - 12.210	3	11.00	9.00	110.00	N/A	14.000	9008150140000	○
M16 X 2.00	D6/D7	13.835 - 14.210	3	12.00	9.00	110.00	N/A	16.000	9008150160000	○
M18 X 2.50	D6/D7	15.294 - 15.744	4	14.00	11.00	125.00	N/A	18.000	9008150180000	●
M20 X 2.50	D6/D7	17.294 - 17.744	4	16.00	12.00	140.00	N/A	20.000	9008150200000	●
M22 X 2.50	D6/D7	19.294 - 19.744	4	18.00	14.50	140.00	N/A	22.000	9008150220000	●
M24 X 3.00	D7/D8	20.752 - 21.252	4	18.00	14.50	160.00	N/A	24.000	9008150240000	○
M27 X 3.00	D7/D8	23.752 - 24.252	4	20.00	16.00	160.00	N/A	27.000	9008150270000	○
M30 X 3.50	D8/D9	26.211 - 26.771	4	22.00	18.00	180.00	N/A	30.000	9008150300000	○
M36 X 4.00	D8/D9	31.670 - 32.270	5	28.00	22.00	200.00	N/A	36.000	9008150360000	●

METRIC

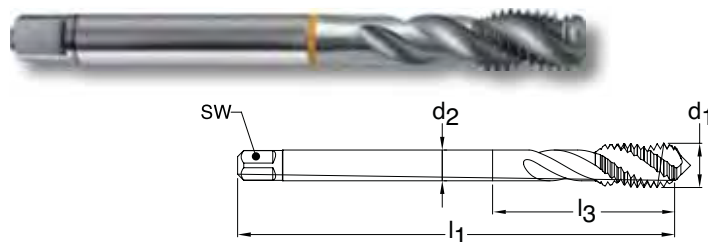

Series 822
Standard DIN 376
Tool Material HSS-E (Cobalt)
Spiral Flute 40° Helix
Chamfer Form C • 2-3
Class of Fit ISO 2(6H)



Blind holes

Bright finish

External cooling

d1 - P	D Limits	Tap Drill Range mm	Number of Flutes	d2 mm	SW mm	l1 mm	l3 mm	Order Code	EDP Number	Stock
M3 X 0.50	D2/D3	2.459 - 2.599	3	2.20	N/A	56.00	N/A	3.000	9008220030000	○
M3.5 X 0.60	D3/D4	2.850 - 3.010	3	2.50	2.10	56.00	N/A	3.500	9008220035000	○
M4 X 0.70	D3/D4	3.242 - 3.422	3	2.80	2.10	63.00	N/A	4.000	9008220040000	●
M5 X 0.80	D3/D4	4.134 - 4.334	3	3.50	2.70	70.00	N/A	5.000	9008220050000	●
M6 X 1.00	D4/D5	4.917 - 5.153	3	4.50	3.40	80.00	N/A	6.000	9008220060000	○
M7 X 1.00	D4/D5	5.917 - 6.153	3	5.50	4.30	80.00	N/A	7.000	9008220070000	●
M8 X 1.25	D4/D5	6.647 - 6.912	3	6.00	4.90	90.00	N/A	8.000	9008220080000	●
M10 X 1.50	D4/D5	8.376 - 8.676	3	7.00	5.50	100.00	N/A	10.000	9008220100000	●
M12 X 1.75	D5/D6	10.106 - 10.441	3	9.00	7.00	110.00	N/A	12.000	9008220120000	○
M14 X 2.00	D5/D6	11.835 - 12.210	3	11.00	9.00	110.00	N/A	14.000	9008220140000	●
M16 X 2.00	D6/D7	13.835 - 14.210	3	12.00	9.00	110.00	N/A	16.000	9008220160000	●
M18 X 2.50	D6/D7	15.294 - 15.744	4	14.00	11.00	125.00	N/A	18.000	9008220180000	●
M20 X 2.50	D6/D7	17.294 - 17.744	4	16.00	12.00	140.00	N/A	20.000	9008220200000	○
M22 X 2.50	D6/D7	19.294 - 19.744	4	18.00	14.50	140.00	N/A	22.000	9008220220000	●
M24 X 3.00	D7/D8	20.752 - 21.252	4	18.00	14.50	160.00	N/A	24.000	9008220240000	○
M27 X 3.00	D7/D8	23.752 - 24.252	4	20.00	16.00	160.00	N/A	27.000	9008220270000	○
M30 X 3.50	D8/D9	26.211 - 26.771	4	22.00	18.00	180.00	N/A	30.000	9008220300000	○

"Tap drill Range" given is per the Class of Fit shown per Series #
 Additional Tap Drill sizes & percent of thread engagement can be found on pages 229-237

METRIC FINE

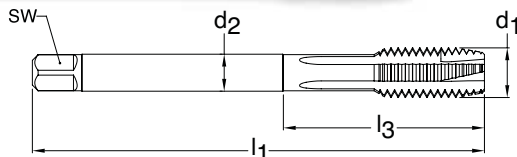

Series 827
Standard DIN 374
Tool Material HSS-E (Cobalt)
Spiral Point Straight flute
Chamfer Form B • 3.5 - 5
Class of Fit ISO 2(6H)

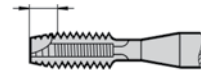

Through holes
 Bright finish
 External cooling

d1 - P	D Limits	Tap Drill Range mm	Number of Flutes	d2 mm	SW mm	l1 mm	l3 mm	Order Code	EDP Number	Stock
M3 X 0.35	D2/D3	2.621 - 2.721	3	2.20	N/A	56.00	N/A	3.002	9008270030020	●
M3.5 X 0.35	D3/D4	3.121 - 3.221	3	2.50	2.10	56.00	N/A	3.502	9008270035020	●
M4 X 0.50	D3/D4	3.459 - 3.599	3	2.80	2.10	63.00	N/A	4.003	9008270040030	●
M5 X 0.50	D3/D4	4.459 - 4.599	3	3.50	2.70	70.00	N/A	5.003	9008270050030	●
M6 X 0.50	D3/D4	5.460 - 5.600	3	4.50	3.40	80.00	N/A	6.003	9008270060030	●
M6 X 0.75	D3/D4	5.188 - 5.378	3	4.50	3.40	80.00	N/A	6.004	9008270060040	●
M7 X 0.75	D3/D4	6.188 - 6.378	3	5.50	4.30	80.00	N/A	7.004	9008270070040	●
M8 X 0.50	D3/D4	7.459 - 7.599	3	6.00	4.90	80.00	N/A	8.003	9008270080030	●
M8 X 0.75	D3/D4	7.188 - 7.378	3	6.00	4.90	80.00	N/A	8.004	9008270080040	●
M8 X 1.00	D4/D5	6.917 - 7.153	3	6.00	4.90	90.00	N/A	8.005	9008270080050	●
M9 X 1.00	D4/D5	7.917 - 8.153	3	7.00	5.50	90.00	N/A	9.005	9008270090050	●
M10 X 0.75	D4/D5	9.188 - 9.378	3	7.00	5.50	90.00	N/A	10.004	9008270100040	●
M10 X 1.00	D4/D5	8.917 - 9.153	3	7.00	5.50	90.00	N/A	10.005	9008270100050	●
M10 X 1.25	D4/D5	8.647 - 8.912	3	7.00	5.50	100.00	N/A	10.006	9008270100060	●
M11 X 1.00	D4/D5	9.917 - 10.153	3	8.00	6.20	90.00	N/A	11.005	9008270110050	●
M12 X 1.00	D4/D5	10.917 - 11.153	3	9.00	7.00	100.00	N/A	12.005	9008270120050	●
M12 X 1.25	D4/D5	10.647 - 10.912	3	9.00	7.00	100.00	N/A	12.006	9008270120060	●
M12 X 1.50	D4/D5	10.376 - 10.676	3	9.00	7.00	100.00	N/A	12.007	9008270120070	●
M14 X 1.00	D4/D5	12.917 - 13.153	3	11.00	9.00	100.00	N/A	14.005	9008270140050	●
M14 X 1.25	D4/D5	12.647 - 12.912	3	11.00	9.00	100.00	N/A	14.006	9008270140060	●
M14 X 1.50	D4/D5	12.376 - 12.676	3	11.00	9.00	100.00	N/A	14.007	9008270140070	●
M15 X 1.00	D4/D5	13.917 - 14.153	3	12.00	9.00	100.00	N/A	15.005	9008270150050	○
M15 X 1.50	D4/D5	13.376 - 13.676	3	12.00	9.00	100.00	N/A	15.007	9008270150070	○
M16 X 1.00	D4/D5	14.917 - 15.153	3	12.00	9.00	100.00	N/A	16.005	9008270160050	●
M16 X 1.50	D4/D5	14.376 - 14.676	3	12.00	9.00	100.00	N/A	16.007	9008270160070	●
M18 X 1.00	D4/D5	16.917 - 17.153	4	14.00	11.00	110.00	N/A	18.005	9008270180050	●
M18 X 1.50	D4/D5	16.376 - 16.676	4	14.00	11.00	110.00	N/A	18.007	9008270180070	●
M18 X 2.00	D6/D7	16.390 - 15.840	4	14.00	11.00	125.00	N/A	18.008	9008270180080	●
M20 X 1.00	D6/D7	18.917 - 19.153	4	16.00	12.00	125.00	N/A	20.005	9008270200050	●
M20 X 1.50	D6/D7	18.376 - 18.676	4	16.00	12.00	125.00	N/A	20.007	9008270200070	●
M20 X 2.00	D6/D7	17.835 - 18.210	4	16.00	12.00	140.00	N/A	20.008	9008270200080	●
M22 X 1.50	D6/D7	20.376 - 20.676	4	18.00	14.50	125.00	N/A	22.007	9008270220070	○
M22 X 2.00	D6/D7	19.835 - 20.210	4	18.00	14.50	140.00	N/A	22.008	9008270220080	○
M24 X 1.00	D6/D7	22.917 - 23.153	4	18.00	14.50	140.00	N/A	24.005	9008270240050	○
M24 X 1.50	D6/D7	22.376 - 22.676	4	18.00	14.50	140.00	N/A	24.007	9008270240070	○
M24 X 2.00	D6/D7	21.835 - 22.210	4	18.00	14.50	140.00	N/A	24.008	9008270240080	●
M26 X 1.50	D7/D8	24.790 - 24.380	4	18.00	14.50	140.00	N/A	26.007	9008270260070	●
M27 X 1.50	D7/D8	25.376 - 25.676	4	20.00	16.00	140.00	N/A	27.007	9008270270070	○
M27 X 2.00	D7/D8	24.835 - 25.210	4	20.00	16.00	140.00	N/A	27.008	9008270270080	○
M28 X 1.50	D7/D8	26.376 - 26.676	4	20.00	16.00	140.00	N/A	28.007	9008270280070	○
M30 X 1.50	D7/D8	28.376 - 28.676	4	22.00	18.00	150.00	N/A	30.007	9008270300070	●
M30 X 2.00	D7/D8	27.835 - 28.210	4	22.00	18.00	150.00	N/A	30.008	9008270300080	●
M32 X 1.50	D7/D8	30.376 - 30.676	4	22.00	18.00	150.00	N/A	32.007	9008270320070	○
M33 X 1.50	D7/D8	31.376 - 31.676	4	25.00	20.00	160.00	N/A	33.007	9008270330070	○
M35 X 1.50	D8/D9	33.376 - 33.676	6	28.00	22.00	170.00	N/A	35.007	9008270350070	●
M36 X 1.50	D8/D9	34.376 - 34.676	6	28.00	22.00	170.00	N/A	36.007	9008270360070	○

METRIC - EXTRA LENGTH



Series 998
Standard DIN 357
Tool Material HSS-E (Cobalt)
Spiral Point Straight flute
Chamfer Form B • 3.5 - 5
Class of Fit ISO 2(6H)

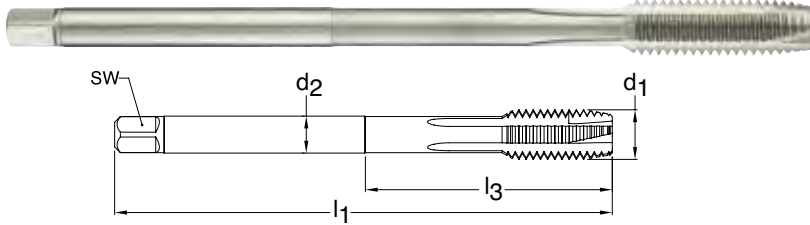

Through holes **Bright finish** **External cooling**

d1 - P	D Limits	Tap Drill Range mm	Number of Flutes	d2 mm	SW mm	l1 mm	l3 mm	Order Code	EDP Number	Stock
M3 x 0.50	D2/D3	2.459 - 2.599	3	2.20	-	70.00	N/A	3.000	9009980030000	○
M4 x 0.70	D3/D4	3.242 - 3.422	3	2.80	2.10	90.00	N/A	4.000	9009980040000	○
M5 x 0.80	D3/D4	4.134 - 4.334	3	3.50	2.70	100.00	N/A	5.000	9009980050000	●
M6 x 1.00	D4/D5	4.917 - 5.153	3	4.50	3.40	110.00	N/A	6.000	9009980060000	●
M8 x 1.25	D4/D5	6.647 - 6.912	3	6.00	4.90	125.00	N/A	8.000	9009980080000	●
M10 x 1.50	D4/D5	8.376 - 8.676	3	7.00	5.50	140.00	N/A	10.000	9009980100000	●
M12 x 1.75	D5/D6	10.106 - 10.441	3	9.00	7.00	180.00	N/A	12.000	9009980120000	●
M14 x 2.00	D5/D6	11.835 - 12.210	3	11.00	9.00	200.00	N/A	14.000	9009980140000	○
M16 x 2.00	D6/D7	13.835 - 14.210	3	12.00	9.00	200.00	N/A	16.000	9009980160000	○
M20 x 2.50	D6/D7	17.294 - 17.744	4	16.00	12.00	250.00	N/A	20.000	9009980200000	○

METRIC FINE

Series 834
Standard DIN 374
Tool Material HSS-E (Cobalt)
Spiral Flute 40° Helix
Chamfer Form C • 2-3
Class of Fit ISO 2(6H)

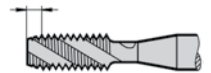
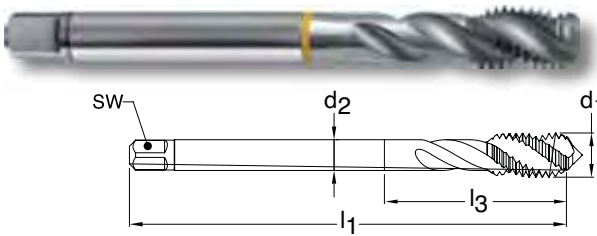

Blind holes **Bright finish** **External cooling**

d1 - P	D Limits	Tap Drill Range mm	Number of Flutes	d2 mm	SW mm	l1 mm	l3 mm	Order Code	EDP Number	Stock
M4 X 0.50	D3/D4	3.459 - 3.599	3	2.80	2.10	63.00	N/A	4.003	9008340040030	○
M5 X 0.50	D3/D4	4.459 - 4.599	3	3.50	2.70	70.00	N/A	5.003	9008340050030	○
M6 X 0.50	D3/D4	5.460 - 5.600	3	4.50	3.40	80.00	N/A	6.003	9008340060030	●
M6 X 0.75	D3/D4	5.188 - 5.378	3	4.50	3.40	80.00	N/A	6.004	9008340060040	○
M8 X 0.75	D3/D4	7.188 - 7.378	3	6.00	4.90	80.00	N/A	8.004	9008340080040	○
M8 X 1.00	D4/D5	6.917 - 7.153	3	6.00	4.90	90.00	N/A	8.005	9008340080050	○
M10 X 1.00	D4/D5	8.917 - 9.153	3	7.00	5.50	90.00	N/A	10.005	9008340100050	○
M10 X 1.25	D4/D5	8.647 - 8.912	3	7.00	5.50	100.00	N/A	10.006	9008340100060	○
M12 X 1.00	D4/D5	10.917 - 11.153	3	9.00	7.00	100.00	N/A	12.005	9008340120050	●
M12 X 1.25	D4/D5	10.647 - 10.912	3	9.00	7.00	100.00	N/A	12.006	9008340120060	●
M12 X 1.50	D4/D5	10.376 - 10.676	3	9.00	7.00	100.00	N/A	12.007	9008340120070	●
M14 X 1.00	D4/D5	12.917 - 13.153	3	11.00	9.00	100.00	N/A	14.005	9008340140050	○
M14 X 1.25	D4/D5	12.647 - 12.912	3	11.00	9.00	100.00	N/A	14.006	9008340140060	●
M14 X 1.50	D4/D5	12.376 - 12.676	3	11.00	9.00	100.00	N/A	14.007	9008340140070	●
M16 X 1.00	D4/D5	14.917 - 15.153	3	12.00	9.00	100.00	N/A	16.005	9008340160050	○
M16 X 1.50	D4/D5	14.376 - 14.676	3	12.00	9.00	100.00	N/A	16.007	9008340160070	●
M18 X 1.00	D4/D5	16.917 - 17.153	4	14.00	11.00	110.00	N/A	18.005	9008340180050	●
M18 X 1.50	D4/D5	16.376 - 16.676	4	14.00	11.00	110.00	N/A	18.007	9008340180070	○
M20 X 1.50	D6/D7	18.376 - 18.676	4	16.00	12.00	125.00	N/A	20.007	9008340200070	●
M22 X 1.50	D6/D7	20.376 - 20.676	4	18.00	14.50	125.00	N/A	22.007	9008340220070	●
M24 X 1.50	D6/D7	22.376 - 22.676	4	18.00	14.50	140.00	N/A	24.007	9008340240070	●
M24 X 2.00	D6/D7	21.835 - 22.210	4	18.00	14.50	140.00	N/A	24.008	9008340240080	○
M26 X 1.50	D7/D8	24.790 - 24.380	4	18.00	14.50	140.00	N/A	26.007	9008340260070	○
M27 X 1.50	D7/D8	25.376 - 25.676	4	20.00	16.00	140.00	N/A	27.007	9008340270070	○
M27 X 2.00	D7/D8	24.835 - 25.210	4	20.00	16.00	140.00	N/A	27.008	9008340270080	●
M30 X 1.50	D7/D8	28.376 - 28.676	4	22.00	18.00	150.00	N/A	30.007	9008340300070	○
M30 X 2.00	D7/D8	27.835 - 28.210	4	22.00	18.00	150.00	N/A	30.008	9008340300080	○

"Tap drill Range" given is per the Class of Fit shown per Series #
 Additional Tap Drill sizes & percent of thread engagement can be found on pages 229-237

METRIC FINE

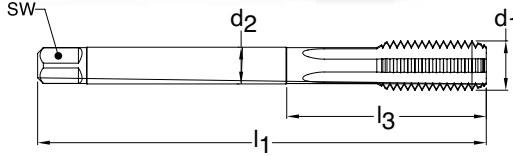

Series 830
Standard DIN 374
Tool Material HSS-E (Cobalt)
Flute Straight flute
Chamfer Form C • 2-3
Class of Fit ISO 2(6H)



Through holes
 Blind holes
 Bright finish
 External cooling

d1 - P	D Limits	Tap Drill Range mm	Number of Flutes	d2 mm	SW mm	l1 mm	l3 mm	Order Code	EDP Number	Stock
M3 X 0.35	D2/D3	2.621 - 2.721	3	2.20	N/A	56.00	N/A	3.002	9008300030020	○
M3.5 X 0.35	D3/D4	3.121 - 3.221	3	2.50	2.10	56.00	N/A	3.502	9008300035020	○
M4 X 0.50	D3/D4	3.459 - 3.599	3	2.80	2.10	63.00	N/A	4.003	9008300040030	○
M5 X 0.50	D3/D4	4.459 - 4.599	3	3.50	2.70	70.00	N/A	5.003	9008300050030	●
M6 X 0.50	D3/D4	5.460 - 5.600	3	4.50	3.40	80.00	N/A	6.003	9008300060030	○
M6 X 0.75	D3/D4	5.188 - 5.378	3	4.50	3.40	80.00	N/A	6.004	9008300060040	●
M7 X 0.75	D3/D4	6.188 - 6.378	3	5.50	4.30	80.00	N/A	7.004	9008300070040	○
M8 X 0.50	D3/D4	7.459 - 7.599	3	6.00	4.90	80.00	N/A	8.003	9008300080030	○
M8 X 0.75	D3/D4	7.188 - 7.378	3	6.00	4.90	80.00	N/A	8.004	9008300080040	○
M8 X 1.00	D4/D5	6.917 - 7.153	3	6.00	4.90	90.00	N/A	8.005	9008300080050	○
M9 X 1.00	D4/D5	7.917 - 8.153	3	7.00	5.50	90.00	N/A	9.005	9008300090050	○
M10 X 0.75	D4/D5	9.188 - 9.378	3	7.00	5.50	90.00	N/A	10.004	9008300100040	○
M10 X 1.00	D4/D5	8.917 - 9.153	3	7.00	5.50	90.00	N/A	10.005	9008300100050	●
M10 X 1.25	D4/D5	8.647 - 8.912	3	7.00	5.50	100.00	N/A	10.006	9008300100060	●
M11 X 1.00	D4/D5	9.917 - 10.153	3	8.00	6.20	90.00	N/A	11.005	9008300110050	○
M12 X 1.00	D4/D5	10.917 - 11.153	3	9.00	7.00	100.00	N/A	12.005	9008300120050	●
M12 X 1.25	D4/D5	10.647 - 10.912	3	9.00	7.00	100.00	N/A	12.006	9008300120060	●
M12 X 1.50	D4/D5	10.376 - 10.676	3	9.00	7.00	100.00	N/A	12.007	9008300120070	●
M14 X 1.00	D4/D5	12.917 - 13.153	3	11.00	9.00	100.00	N/A	14.005	9008300140050	○
M14 X 1.25	D4/D5	12.647 - 12.912	3	11.00	9.00	100.00	N/A	14.006	9008300140060	●
M14 X 1.50	D4/D5	12.376 - 12.676	3	11.00	9.00	100.00	N/A	14.007	9008300140070	○
M15 X 1.00	D4/D5	13.917 - 14.153	3	12.00	9.00	100.00	N/A	15.005	9008300150050	○
M16 X 1.00	D4/D5	14.917 - 15.153	3	12.00	9.00	100.00	N/A	16.005	9008300160050	○
M16 X 1.50	D4/D5	14.376 - 14.676	3	12.00	9.00	100.00	N/A	16.007	9008300160070	●
M18 X 1.00	D4/D5	16.917 - 17.153	4	14.00	11.00	110.00	N/A	18.005	9008300180050	○
M18 X 1.50	D4/D5	16.376 - 16.676	4	14.00	11.00	110.00	N/A	18.007	9008300180070	○
M18 X 2.00	D6/D7	16.390 - 15.840	4	14.00	11.00	125.00	N/A	18.008	9008300180080	○
M20 X 1.00	D6/D7	18.917 - 19.153	4	16.00	12.00	125.00	N/A	20.005	9008300200050	○
M20 X 1.50	D6/D7	18.376 - 18.676	4	16.00	12.00	125.00	N/A	20.007	9008300200070	●
M20 X 2.00	D6/D7	17.835 - 18.210	4	16.00	12.00	140.00	N/A	20.008	9008300200080	○
M22 X 1.00	D6/D7	20.917 - 21.153	4	18.00	14.50	125.00	N/A	22.005	9008300220050	○
M22 X 1.50	D6/D7	20.376 - 20.676	4	18.00	14.50	125.00	N/A	22.007	9008300220070	○
M24 X 1.00	D6/D7	22.917 - 23.153	4	18.00	14.50	140.00	N/A	24.005	9008300240050	○
M24 X 1.50	D6/D7	22.376 - 22.676	4	18.00	14.50	140.00	N/A	24.007	9008300240070	●
M24 X 2.00	D6/D7	21.835 - 22.210	4	18.00	14.50	140.00	N/A	24.008	9008300240080	●
M26 X 1.50	D7/D8	24.790 - 24.380	4	18.00	14.50	140.00	N/A	26.007	9008300260070	○
M27 X 1.50	D7/D8	25.376 - 25.676	4	20.00	16.00	140.00	N/A	27.007	9008300270070	○
M27 X 2.00	D7/D8	24.835 - 25.210	4	20.00	16.00	140.00	N/A	27.008	9008300270080	●
M28 X 1.50	D7/D8	26.376 - 26.676	4	20.00	16.00	140.00	N/A	28.007	9008300280070	○
M30 X 1.50	D7/D8	28.376 - 28.676	4	22.00	18.00	150.00	N/A	30.007	9008300300070	●
M30 X 2.00	D7/D8	27.835 - 28.210	4	22.00	18.00	150.00	N/A	30.008	9008300300080	○
M32 X 1.50	D7/D8	30.376 - 30.676	4	22.00	18.00	150.00	N/A	32.007	9008300320070	○
M35 X 1.50	D8/D9	33.376 - 33.676	6	28.00	22.00	170.00	N/A	35.007	9008300350070	○
M36 X 1.50	D8/D9	34.376 - 34.676	6	28.00	22.00	170.00	N/A	36.007	9008300360070	○
M38 X 1.50	D8/D9	36.380 - 36.790	6	28.00	22.00	170.00	N/A	38.007	9008300380070	●

powertap

UNIVERSAL TAPS

MADE BY
GUHRING

POWERTAP ABSOLUTELY PERFECT

It is a true **universal tap** covering a **broad range of applications** and provides **optimal machining results**.

- High-tensile steels
- Stainless and acid-resistant steels
- Aluminum and aluminum alloys
- General steels
- Cast materials



**TOP QUALITY
FROM GERMANY**
at a Power Price

www.Guhring.com/PowerTap

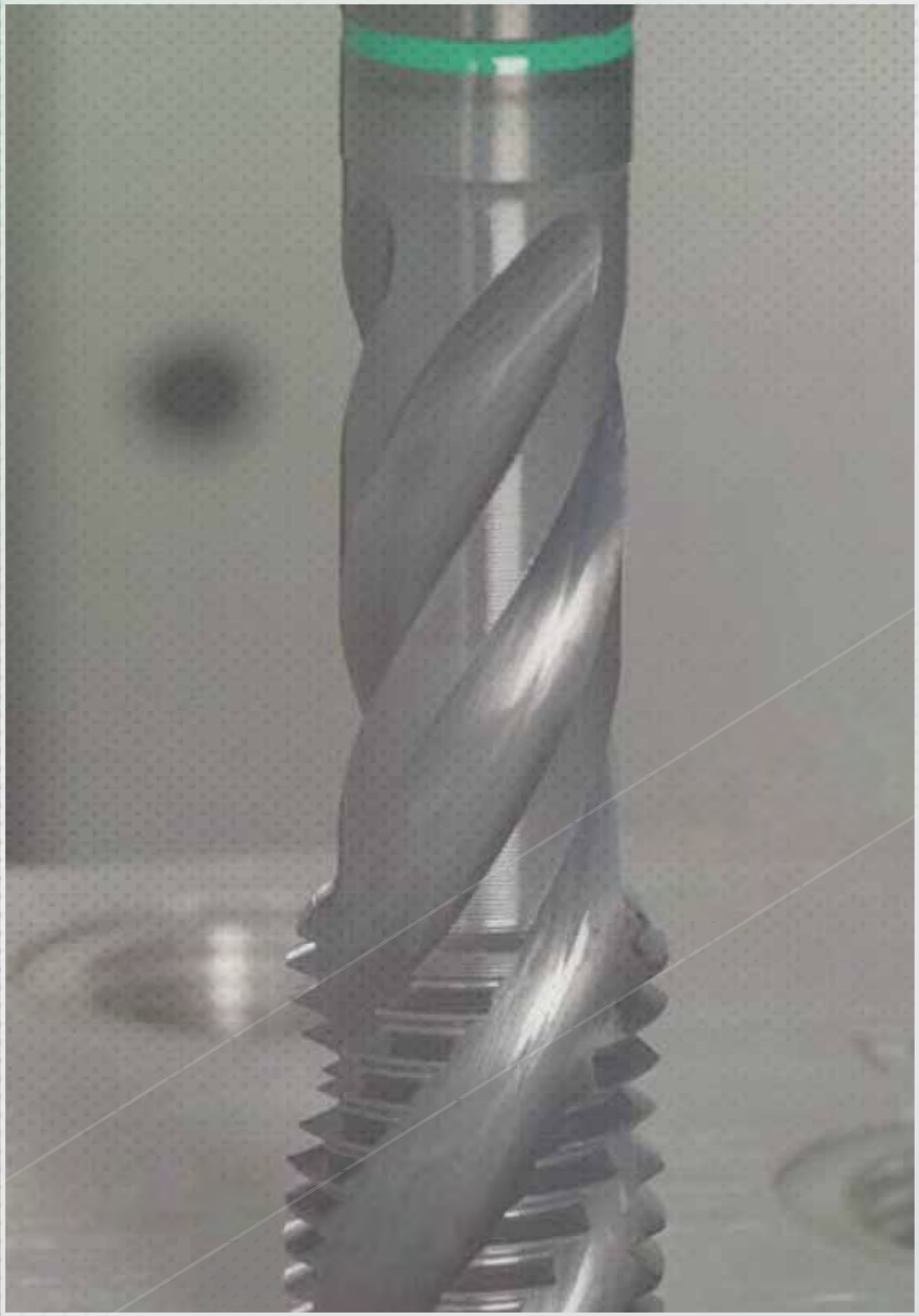

GREEN RING CUT TAPS

Structural steels,
 free-cutting steels
 Case hardened steels,
 heat-treatable steels
 Nitriding steels,
 spheroidal graphite iron

Material group	Approximate Rc	Approximate HB	Recommended SFM			
			HSS-E		HSS-E-PM	
			bright finish	hard coated	bright finish	hard coated
Structural steels, free-cutting steels	<20	<230	40-50	40-75	40-65	40-80
Case hardened steels, heat-treatable steels	<25	<250	30-45	30-65	30-60	35-75
Nitriding steels, spheroidal graphite iron	<30	<280	20-30	30-55	30-50	35-65
	<35	<320	15-25	20-35	25-45	30-60
	<38	<380	10-23	20-40	20-45	30-55

UNC

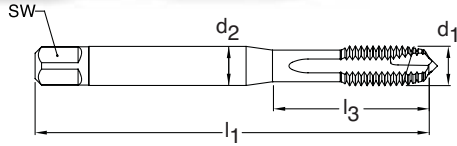

Series 3913
Standard ANSI
Tool Material HSS-E (Cobalt)
Spiral Point Straight flute
Chamfer Form B • 3.5 - 5
Class of Fit 2B

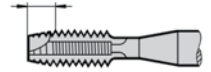

Through holes Bright finish External cooling

d1 - P	H Limits	Tap Drill Range inch	Number of Flutes	d2 inch	SW inch	l1 inch	l3 inch	Order Code	EDP Number	Stock
2-56	H2/H3	0.067 - 0.074	3	0.141	0.110	1.752	0.441	2.184	9039130021840	●
3-48	H2/H3	0.076 - 0.084	3	0.141	0.110	1.811	0.500	2.515	9039130025150	●
4-40	H2/H3	0.085 - 0.094	3	0.141	0.110	1.882	0.709	2.845	9039130028450	●
5-40	H2/H3	0.098 - 0.106	3	0.141	0.110	1.941	0.709	3.175	9039130031750	●
6-32	H3/H4	0.104 - 0.114	3	0.141	0.110	2.000	0.748	3.505	9039130035050	●
8-32	H3/H4	0.130 - 0.139	3	0.168	0.131	2.130	0.827	4.166	9039130041660	●
10-24	H3/H4	0.145 - 0.155	3	0.194	0.152	2.382	0.945	4.826	9039130048260	●
12-24	H3/H4	0.171 - 0.181	3	0.220	0.165	2.382	1.024	5.486	9039130054860	●
1/4-20	H4/H5	0.196 - 0.207	3	0.255	0.191	2.500	1.181	6.350	9039130063500	●
5/16-18	H4/H5	0.252 - 0.265	3	0.318	0.238	2.721	1.377	7.938	9039130079380	●
3/8-16	H5/H6	0.307 - 0.321	3	0.381	0.286	2.941	1.456	9.525	9039130095250	●
7/16-14	H5/H6	0.360 - 0.376	3	0.323	0.242	3.161	N/A	11.113	9039130111130	●
1/2-13	H5/H6	0.417 - 0.434	4	0.367	0.275	3.382	N/A	12.700	9039130127000	●
9/16-12	H5/H6	0.472 - 0.490	4	0.429	0.322	3.591	N/A	14.288	9039130142880	●
5/8-11	H5/H6	0.527 - 0.546	4	0.480	0.360	3.811	N/A	15.875	9039130158750	●
3/4-10	H5/H6	0.642 - 0.663	4	0.590	0.442	4.252	N/A	19.050	9039130190500	●
7/8-9	H6/H7	0.755 - 0.778	4	0.697	0.523	4.689	N/A	22.225	9039130222500	●
1-8	H6/H7	0.865 - 0.890	4	0.800	0.600	5.130	N/A	25.400	9039130254000	●
1 1/8- 7	H6/H7	0.970 - 0.998	4	0.896	0.672	5.441	N/A	28.575	9039130285750	●
1 1/4- 7	H7/H8	1.095 - 1.123	4	1.021	0.766	5.748	N/A	31.750	9039130317500	●
1 3/8- 6	H7/H8	1.195 - 1.225	5	1.108	0.831	6.063	N/A	34.925	9039130349250	●
1 1/2-6	H7/H8	1.320 - 1.350	5	1.233	0.925	6.378	N/A	38.100	9039130381000	●

UNC

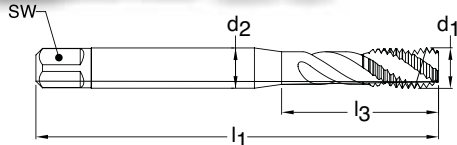

Series 3919
Standard ANSI
Tool Material HSS-E (Cobalt)
Spiral Flute 40° Helix
Chamfer Form C • 2-3
Class of Fit 2B

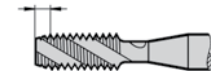

Blind holes Bright finish External cooling

d1 - P	H Limits	Tap Drill Range inch	Number of Flutes	d2 inch	SW inch	l1 inch	l3 inch	Order Code	EDP Number	Stock
2-56	H2/H3	0.067 - 0.074	3	0.141	0.110	1.752	0.441	2.184	9039190021840	●
3-48	H2/H3	0.076 - 0.084	3	0.141	0.110	1.811	0.500	2.515	9039190025150	●
4-40	H2/H3	0.085 - 0.940	3	0.141	0.110	1.882	0.709	2.845	9039190028450	●
5-40	H2/H3	0.098 - 0.106	3	0.141	0.110	1.941	0.709	3.175	9039190031750	●
6-32	H3/H4	0.104 - 0.114	3	0.141	0.110	2.000	0.748	3.505	9039190035050	●
8-32	H3/H4	0.130 - 0.139	3	0.168	0.131	2.130	0.827	4.166	9039190041660	●
10-24	H3/H4	0.145 - 0.155	3	0.194	0.152	2.382	0.945	4.826	9039190048260	●
12-24	H3/H4	0.171 - 0.181	3	0.220	0.165	2.382	1.024	5.486	9039190054860	●
1/4-20	H4/H5	0.196 - 0.207	3	0.255	0.191	2.500	1.181	6.350	9039190063500	●
5/16-18	H4/H5	0.252 - 0.265	3	0.318	0.238	2.721	1.377	7.938	9039190079380	●
3/8-16	H5/H6	0.307 - 0.321	3	0.381	0.286	2.941	1.456	9.525	9039190095250	●
7/16-14	H5/H6	0.360 - 0.376	3	0.323	0.242	3.161	N/A	11.113	9039190111130	●
1/2-13	H5/H6	0.417 - 0.434	3	0.367	0.275	3.382	N/A	12.700	9039190127000	●
9/16-12	H5/H6	0.472 - 0.490	3	0.429	0.322	3.591	N/A	14.288	9039190142880	●
5/8-11	H5/H6	0.527 - 0.546	4	0.480	0.360	3.811	N/A	15.875	9039190158750	●
3/4-10	H5/H6	0.642 - 0.663	4	0.590	0.442	4.252	N/A	19.050	9039190190500	●
7/8-9	H6/H7	0.755 - 0.778	4	0.697	0.523	4.689	N/A	22.225	9039190222500	●
1-8	H6/H7	0.865 - 0.890	4	0.800	0.600	5.130	N/A	25.400	9039190254000	●
1 1/8- 7	H6/H7	0.970 - 0.998	4	0.896	0.672	5.441	N/A	28.575	9039190285750	●
1 1/4- 7	H7/H8	1.095 - 1.123	4	1.021	0.766	5.748	N/A	31.750	9039190317500	●
1 3/8- 6	H7/H8	1.195 - 1.225	4	1.108	0.831	6.063	N/A	34.925	9039190349250	●
1 1/2-6	H7/H8	1.320 - 1.350	6	1.233	0.925	6.378	N/A	38.100	9039190381000	●

UNF

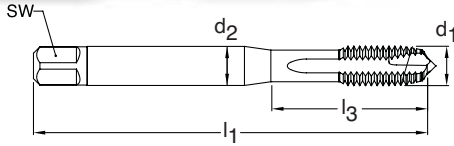

Series 3914
Standard ANSI
Tool Material HSS-E (Cobalt)
Spiral Point Straight flute
Chamfer Form B • 3.5 - 5
Class of Fit 2B



Through holes



Bright finish



External cooling

d1 - P	H Limits	Tap Drill Range inch	Number of Flutes	d2 inch	SW inch	l1 inch	l3 inch	Order Code	EDP Number	Stock
2-64	H2/H3	0.069 - 0.075	3	0.141	0.110	1.752	0.441	2.184	9039140021840	●
3-56	H2/H3	0.080 - 0.086	3	0.141	0.110	1.811	0.500	2.515	9039140025150	●
4-48	H2/H3	0.089 - 0.097	3	0.141	0.110	1.882	0.709	2.845	9039140028450	●
5-44	H2/H3	0.100 - 0.108	3	0.141	0.110	1.941	0.709	3.175	9039140031750	●
6-40	H2/H3	0.111 - 0.119	3	0.141	0.110	2.000	0.748	3.505	9039140035050	●
8-36	H2/H3	0.134 - 0.142	3	0.168	0.131	2.130	0.827	4.166	9039140041660	●
10-32	H3/H4	0.156 - 0.164	3	0.194	0.152	2.382	0.945	4.826	9039140048260	●
12-28	H3/H4	0.177 - 0.186	3	0.220	0.165	2.382	1.024	5.486	9039140054860	●
1/4-28	H3/H4	0.211 - 0.220	3	0.255	0.191	2.500	1.181	6.350	9039140063500	●
5/16-24	H3/H4	0.267 - 0.277	3	0.318	0.238	2.721	1.377	7.938	9039140079380	●
3/8-24	H3/H4	0.330 - 0.340	3	0.381	0.286	2.941	1.456	9.525	9039140095250	●
7/16-20	H4/H5	0.383 - 0.395	3	0.323	0.242	3.161	N/A	11.113	9039140111130	●
1/2-20	H4/H5	0.446 - 0.457	4	0.367	0.275	3.382	N/A	12.700	9039140127000	●
9/16-18	H4/H5	0.502 - 0.515	4	0.429	0.322	3.591	N/A	14.288	9039140142880	●
5/8-18	H4/H5	0.565 - 0.578	4	0.480	0.360	3.811	N/A	15.875	9039140158750	●
3/4-16	H5/H6	0.682 - 0.696	4	0.590	0.442	4.252	N/A	19.050	9039140190500	●
7/8-14	H6/H7	0.798 - 0.813	4	0.697	0.523	4.689	N/A	22.225	9039140222250	●
1-12	H6/H7	0.910 - 0.928	4	0.800	0.600	5.130	N/A	25.400	9039140254000	●
1 1/8- 12	H6/H7	1.035 - 1.053	4	0.896	0.672	5.441	N/A	28.575	9039140285750	●
1 1/4-12	H6/H7	1.160 - 1.178	4	1.021	0.766	5.748	N/A	31.750	9039140317500	●
1 3/8-12	H6/H7	1.285 - 1.303	6	1.108	0.831	6.063	N/A	34.925	9039140349250	●
1 1/2-12	H6/H7	1.410 - 1.428	6	1.233	0.925	6.378	N/A	38.100	9039140381000	●

UNF

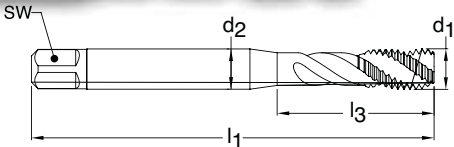

Series 3920
Standard ANSI
Tool Material HSS-E (Cobalt)
Spiral Flute 40° Helix
Chamfer Form C • 2-3
Class of Fit 2B



Blind holes



Bright finish



External cooling

d1 - P	H Limits	Tap Drill Range inch	Number of Flutes	d2 inch	SW inch	l1 inch	l3 inch	Order Code	EDP Number	Stock
2-64	H2/H3	0.069 - 0.075	3	0.141	0.110	1.752	0.441	2.184	9039200021840	●
3-56	H2/H3	0.080 - 0.086	3	0.141	0.110	1.811	0.500	2.515	9039200025150	●
4-48	H2/H3	0.089 - 0.097	3	0.141	0.110	1.882	0.709	2.845	9039200028450	●
5-44	H2/H3	0.100 - 0.108	3	0.141	0.110	1.941	0.709	3.175	9039200031750	●
6-40	H2/H3	0.111 - 0.119	3	0.141	0.110	2.000	0.748	3.505	9039200035050	●
8-36	H2/H3	0.134 - 0.142	3	0.168	0.131	2.130	0.827	4.166	9039200041660	●
10-32	H3/H4	0.156 - 0.164	3	0.194	0.152	2.382	0.945	4.826	9039200048260	●
12-28	H3/H4	0.177 - 0.186	3	0.220	0.165	2.382	1.024	5.486	9039200054860	●
1/4-28	H3/H4	0.211 - 0.220	3	0.255	0.191	2.500	1.181	6.350	9039200063500	●
5/16-24	H3/H4	0.267 - 0.277	3	0.318	0.238	2.721	1.377	7.938	9039200079380	●
3/8-24	H3/H4	0.330 - 0.340	3	0.381	0.286	2.941	1.456	9.525	9039200095250	●
7/16-20	H4/H5	0.383 - 0.395	3	0.323	0.242	3.161	N/A	11.113	9039200111130	●
1/2-20	H4/H5	0.446 - 0.457	3	0.367	0.275	3.382	N/A	12.700	9039200127000	●
9/16-18	H4/H5	0.502 - 0.515	3	0.429	0.322	3.591	N/A	14.288	9039200142880	●
5/8-18	H4/H5	0.565 - 0.578	4	0.480	0.360	3.811	N/A	15.875	9039200158750	●
3/4-16	H5/H6	0.682 - 0.696	4	0.590	0.442	4.252	N/A	19.050	9039200190500	●
7/8-14	H6/H7	0.798 - 0.813	4	0.697	0.523	4.689	N/A	22.225	9039200222250	●
1-12	H6/H7	0.910 - 0.928	4	0.800	0.600	5.130	N/A	25.400	9039200254000	●
1 1/8- 12	H6/H7	1.035 - 1.053	4	0.896	0.672	5.441	N/A	28.575	9039200285750	●
1 1/4-12	H6/H7	1.160 - 1.178	4	1.021	0.766	5.748	N/A	31.750	9039200317500	●
1 1/2-12	H6/H7	1.410 - 1.428	6	1.233	0.925	6.378	N/A	38.100	9039200381000	●

"Tap drill Range" given is per the Class of Fit shown per Series #
 Additional Tap Drill sizes & percent of thread engagement can be found on pages 229-237.

UNC

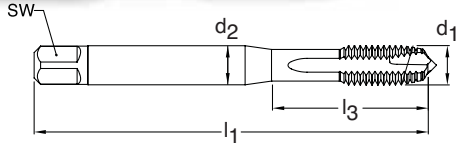

Series 3916
Standard ANSI
Tool Material HSS-E (Cobalt)
Spiral Point Straight flute
Chamfer Form B • 3.5 - 5
Class of Fit 2B



Through holes **TiN coated** **External cooling**

d1 - P	H Limits	Tap Drill Range inch	Number of Flutes	d2 inch	SW inch	l1 inch	l3 inch	Order Code	EDP Number	Stock
2-56	H2/H3	0.067 - 0.074	3	0.141	0.110	1.752	0.441	2.184	9039160021840	●
3-48	H2/H3	0.076 - 0.084	3	0.141	0.110	1.811	0.500	2.515	9039160025150	●
4-40	H2/H3	0.085 - 0.094	3	0.141	0.110	1.882	0.709	2.845	9039160028450	●
5-40	H2/H3	0.098 - 0.106	3	0.141	0.110	1.941	0.709	3.175	9039160031750	●
6-32	H3/H4	0.104 - 0.114	3	0.141	0.110	2.000	0.748	3.505	9039160035050	●
8-32	H3/H4	0.130 - 0.139	3	0.168	0.131	2.130	0.827	4.166	9039160041660	●
10-24	H3/H4	0.145 - 0.155	3	0.194	0.152	2.382	0.945	4.826	9039160048260	●
12-24	H3/H4	0.171 - 0.181	3	0.220	0.165	2.382	1.024	5.486	9039160054860	●
1/4-20	H4/H5	0.196 - 0.207	3	0.255	0.191	2.500	1.181	6.350	9039160063500	●
5/16-18	H4/H5	0.252 - 0.265	3	0.318	0.238	2.721	1.377	7.938	9039160079380	●
3/8-16	H5/H6	0.307 - 0.321	3	0.381	0.286	2.941	1.456	9.525	9039160095250	●
7/16-14	H5/H6	0.360 - 0.376	3	0.323	0.242	3.161	N/A	11.113	9039160111130	●
1/2-13	H5/H6	0.417 - 0.434	4	0.367	0.275	3.382	N/A	12.700	9039160127000	●
9/16-12	H5/H6	0.472 - 0.490	4	0.429	0.322	3.591	N/A	14.288	9039160142880	●
5/8-11	H5/H6	0.527 - 0.546	4	0.480	0.360	3.811	N/A	15.875	9039160158750	●
3/4-10	H5/H6	0.642 - 0.663	4	0.590	0.442	4.252	N/A	19.050	9039160190500	●
7/8-9	H6/H7	0.755 - 0.778	4	0.697	0.523	4.689	N/A	22.225	9039160222250	●
1-8	H6/H7	0.865 - 0.890	4	0.800	0.600	5.130	N/A	25.400	9039160254000	●
1 1/8-7	H6/H7	0.970 - 0.998	4	0.896	0.672	5.441	N/A	28.575	9039160285750	●
1 1/4-7	H7/H8	1.095 - 1.123	4	1.021	0.766	5.748	N/A	31.750	9039160317500	●
1 3/8-6	H7/H8	1.195 - 1.225	5	1.108	0.831	6.063	N/A	34.925	9039160349250	●
1 1/2-6	H7/H8	1.320 - 1.350	5	1.233	0.925	6.378	N/A	38.100	9039160381000	●

UNC

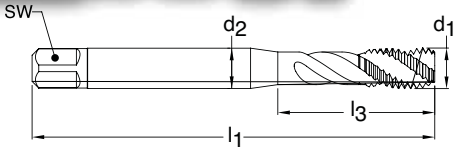

Series 3922
Standard ANSI
Tool Material HSS-E (Cobalt)
Spiral Flute 40° Helix
Chamfer Form C • 2-3
Class of Fit 2B

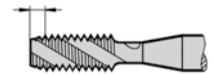

Blind holes **TiN coated** **External cooling**

d1 - P	H Limits	Tap Drill Range inch	Number of Flutes	d2 inch	SW inch	l1 inch	l3 inch	Order Code	EDP Number	Stock
2-56	H2/H3	0.067 - 0.074	3	0.141	0.110	1.752	0.441	2.184	9039220021840	●
3-48	H2/H3	0.076 - 0.084	3	0.141	0.110	1.811	0.500	2.515	9039220025150	●
4-40	H2/H3	0.085 - 0.094	3	0.141	0.110	1.882	0.709	2.845	9039220028450	●
5-40	H2/H3	0.098 - 0.106	3	0.141	0.110	1.941	0.709	3.175	9039220031750	●
6-32	H3/H4	0.104 - 0.114	3	0.141	0.110	2.000	0.748	3.505	9039220035050	●
8-32	H3/H4	0.130 - 0.139	3	0.168	0.131	2.130	0.827	4.166	9039220041660	●
10-24	H3/H4	0.145 - 0.155	3	0.194	0.152	2.382	0.945	4.826	9039220048260	●
12-24	H3/H4	0.171 - 0.181	3	0.220	0.165	2.382	1.024	5.486	9039220054860	●
1/4-20	H4/H5	0.196 - 0.207	3	0.255	0.191	2.500	1.181	6.350	9039220063500	●
5/16-18	H4/H5	0.252 - 0.265	3	0.318	0.238	2.721	1.377	7.938	9039220079380	●
3/8-16	H5/H6	0.307 - 0.321	3	0.381	0.286	2.941	1.456	9.525	9039220095250	●
7/16-14	H5/H6	0.360 - 0.376	3	0.323	0.242	3.161	N/A	11.113	9039220111130	●
1/2-13	H5/H6	0.417 - 0.434	3	0.367	0.275	3.382	N/A	12.700	9039220127000	●
9/16-12	H5/H6	0.472 - 0.490	3	0.429	0.322	3.591	N/A	14.288	9039220142880	●
5/8-11	H5/H6	0.527 - 0.546	4	0.480	0.360	3.811	N/A	15.875	9039220158750	●
3/4-10	H5/H6	0.642 - 0.663	4	0.590	0.442	4.252	N/A	19.050	9039220190500	●
7/8-9	H6/H7	0.755 - 0.778	4	0.697	0.523	4.689	N/A	22.225	9039220222250	●
1-8	H6/H7	0.865 - 0.890	4	0.800	0.600	5.130	N/A	25.400	9039220254000	●
1 1/8-7	H6/H7	0.970 - 0.998	4	0.896	0.672	5.441	N/A	28.575	9039220285750	●
1 1/4-7	H7/H8	1.095 - 1.123	4	1.021	0.766	5.748	N/A	31.750	9039220317500	●
1 3/8-6	H7/H8	1.195 - 1.225	4	1.108	0.831	6.063	N/A	34.925	9039220349250	●
1 1/2-6	H7/H8	1.320 - 1.350	6	1.233	0.925	6.378	N/A	38.100	9039220381000	●

UNF

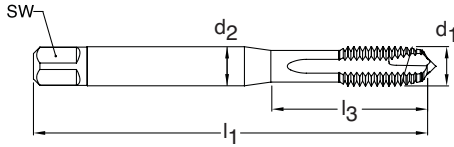

Series 3917
Standard ANSI
Tool Material HSS-E (Cobalt)
Spiral Point Straight flute
Chamfer Form B • 3.5 - 5
Class of Fit 2B



Through holes



TiN coated



External cooling

d1 - P	H Limits	Tap Drill Range inch	Number of Flutes	d2 inch	SW inch	l1 inch	l3 inch	Order Code	EDP Number	Stock
2-64	H2/H3	0.069 - 0.075	3	0.141	0.110	1.752	0.441	2.184	9039170021840	●
3-56	H2/H3	0.080 - 0.086	3	0.141	0.110	1.811	0.500	2.515	9039170025150	●
4-48	H2/H3	0.089 - 0.097	3	0.141	0.110	1.882	0.709	2.845	9039170028450	●
5-44	H2/H3	0.100 - 0.108	3	0.141	0.110	1.941	0.709	3.175	9039170031750	●
6-40	H2/H3	0.111 - 0.119	3	0.141	0.110	2.000	0.748	3.505	9039170035050	●
8-36	H2/H3	0.134 - 0.142	3	0.168	0.131	2.130	0.827	4.166	9039170041660	●
10-32	H3/H4	0.156 - 0.164	3	0.194	0.152	2.382	0.945	4.826	9039170048260	●
12-28	H3/H4	0.177 - 0.186	3	0.220	0.165	2.382	1.024	5.486	9039170054860	●
1/4-28	H3/H4	0.211 - 0.220	3	0.255	0.191	2.500	1.181	6.350	9039170063500	●
5/16-24	H3/H4	0.267 - 0.277	3	0.318	0.238	2.721	1.377	7.938	9039170079380	●
3/8-24	H3/H4	0.330 - 0.340	3	0.381	0.286	2.941	1.456	9.525	9039170095250	●
7/16-20	H4/H5	0.383 - 0.395	3	0.323	0.242	3.161	N/A	11.113	9039170111130	●
1/2-20	H4/H5	0.446 - 0.457	4	0.367	0.275	3.382	N/A	12.700	9039170127000	●
9/16-18	H4/H5	0.502 - 0.515	4	0.429	0.322	3.591	N/A	14.288	9039170142880	●
5/8-18	H4/H5	0.565 - 0.578	4	0.480	0.360	3.811	N/A	15.875	9039170158750	●
3/4-16	H5/H6	0.682 - 0.696	4	0.590	0.442	4.252	N/A	19.050	9039170190500	●
7/8-14	H6/H7	0.798 - 0.813	4	0.697	0.523	4.689	N/A	22.225	9039170222250	●
1-12	H6/H7	0.910 - 0.928	4	0.800	0.600	5.130	N/A	25.400	9039170254000	●
1 1/8- 12	H6/H7	1.035 - 1.053	4	0.896	0.672	5.441	N/A	28.575	9039170285750	●
1 1/4-12	H6/H7	1.160 - 1.178	4	1.021	0.766	5.748	N/A	31.750	9039170317500	●
1 3/8- 12	H6/H7	1.285 - 1.303	6	1.108	0.831	6.063	N/A	34.925	9039170349250	●
1 1/2-12	H6/H7	1.410 - 1.428	6	1.233	0.925	6.378	N/A	38.100	9039170381000	●

UNF

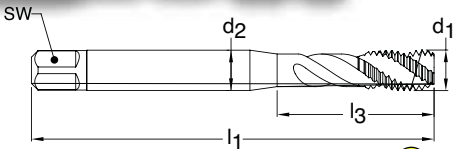

Series 3923
Standard ANSI
Tool Material HSS-E (Cobalt)
Spiral Flute 40° Helix
Chamfer Form C • 2-3
Class of Fit 2B



Blind holes



TiN coated



External cooling

d1 - P	H Limits	Tap Drill Range inch	Number of Flutes	d2 inch	SW inch	l1 inch	l3 inch	Order Code	EDP Number	Stock
2-64	H2/H3	0.069 - 0.075	3	0.141	0.110	1.752	0.631	2.184	9039230021840	●
3-56	H2/H3	0.080 - 0.086	3	0.141	0.110	1.811	0.631	2.515	9039230025150	●
4-48	H2/H3	0.089 - 0.097	3	0.141	0.110	1.882	0.709	2.845	9039230028450	●
5-44	H2/H3	0.100 - 0.108	3	0.141	0.110	1.941	0.709	3.175	9039230031750	●
6-40	H2/H3	0.111 - 0.119	3	0.141	0.110	2.000	0.748	3.505	9039230035050	●
8-36	H2/H3	0.134 - 0.142	3	0.168	0.131	2.130	0.827	4.166	9039230041660	●
10-32	H3/H4	0.156 - 0.164	3	0.194	0.152	2.382	0.945	4.826	9039230048260	●
12-28	H3/H4	0.177 - 0.186	3	0.220	0.165	2.382	1.024	5.486	9039230054860	●
1/4-28	H3/H4	0.211 - 0.220	3	0.255	0.191	2.500	1.181	6.350	9039230063500	●
5/16-24	H3/H4	0.267 - 0.277	3	0.318	0.238	2.721	1.377	7.938	9039230079380	●
3/8-24	H3/H4	0.330 - 0.340	3	0.381	0.286	2.941	1.456	9.525	9039230095250	●
7/16-20	H4/H5	0.383 - 0.395	3	0.323	0.242	3.161	N/A	11.113	9039230111130	●
1/2-20	H4/H5	0.446 - 0.457	3	0.367	0.275	3.382	N/A	12.700	9039230127000	●
9/16-18	H4/H5	0.502 - 0.515	3	0.429	0.322	3.591	N/A	14.288	9039230142880	●
5/8-18	H4/H5	0.565 - 0.578	4	0.480	0.360	3.811	N/A	15.875	9039230158750	●
3/4-16	H5/H6	0.682 - 0.696	4	0.590	0.442	4.252	N/A	19.050	9039230190500	●
7/8-14	H6/H7	0.798 - 0.813	4	0.697	0.523	4.689	N/A	22.225	9039230222250	●
1-12	H6/H7	0.910 - 0.928	4	0.800	0.600	5.130	N/A	25.400	9039230254000	●
1 1/8- 12	H6/H7	1.035 - 1.053	4	0.896	0.672	5.441	N/A	28.575	9039230285750	●
1 1/4-12	H6/H7	1.160 - 1.178	4	1.021	0.766	5.748	N/A	31.750	9039230317500	●
1 3/8- 12	H6/H7	1.285 - 1.303	4	1.108	0.831	6.063	N/A	34.925	9039230349250	●
1 1/2-12	H6/H7	1.410 - 1.428	6	1.233	0.925	6.378	N/A	38.100	9039230381000	●

"Tap drill Range" given is per the Class of Fit shown per Series #

Additional Tap Drill sizes & percent of thread engagement can be found on pages 229-237.

UNC

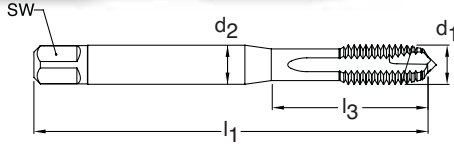

Through holes



TiCN coated



External cooling

Series 3946
Standard ANSI
Tool Material HSS-E (Cobalt)
Spiral Point Straight flute
Chamfer Form B • 3.5 - 5
Class of Fit 2B

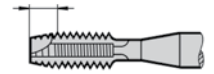

d1 - P	H Limits	Tap Drill Range inch	Number of Flutes	d2 inch	SW inch	l1 inch	l3 inch	Order Code	EDP Number	Stock
2-56	H2/H3	0.067 - 0.074	3	0.141	0.110	1.752	0.441	2.184	9039460021840	●
3-48	H2/H3	0.076 - 0.084	3	0.141	0.110	1.811	0.500	2.515	9039460025150	●
4-40	H2/H3	0.085 - 0.094	3	0.141	0.110	1.882	0.709	2.845	9039460028450	●
5-40	H2/H3	0.098 - 0.106	3	0.141	0.110	1.941	0.709	3.175	9039460031750	●
6-32	H3/H4	0.104 - 0.114	3	0.141	0.110	2.000	0.748	3.505	9039460035050	●
8-32	H3/H4	0.130 - 0.139	3	0.168	0.131	2.130	0.827	4.166	9039460041660	●
10-24	H3/H4	0.145 - 0.155	3	0.194	0.152	2.382	0.945	4.826	9039460048260	●
12-24	H3/H4	0.171 - 0.181	3	0.220	0.165	2.382	1.024	5.486	9039460054860	●
1/4-20	H4/H5	0.196 - 0.207	3	0.255	0.191	2.500	1.181	6.350	9039460063500	●
5/16-18	H4/H5	0.252 - 0.265	3	0.318	0.238	2.721	1.377	7.938	9039460079380	●
3/8-16	H5/H6	0.307 - 0.321	3	0.381	0.286	2.941	1.456	9.525	9039460095250	●
7/16-14	H5/H6	0.360 - 0.376	3	0.323	0.242	3.161	N/A	11.113	9039460111130	●
1/2-13	H5/H6	0.417 - 0.434	4	0.367	0.275	3.382	N/A	12.700	9039460127000	●
9/16-12	H5/H6	0.472 - 0.490	4	0.429	0.322	3.591	N/A	14.288	9039460142880	●
5/8-11	H5/H6	0.527 - 0.546	4	0.480	0.360	3.811	N/A	15.875	9039460158750	●
3/4-10	H5/H6	0.642 - 0.663	4	0.590	0.442	4.252	N/A	19.050	9039460190500	●
7/8-9	H6/H7	0.755 - 0.778	4	0.697	0.523	4.689	N/A	22.225	9039460222250	●
1-8	H6/H7	0.865 - 0.890	4	0.800	0.600	5.130	N/A	25.400	9039460254000	●
1 1/8- 7	H6/H7	0.970 - 0.998	4	0.896	0.672	5.441	N/A	28.575	9039460285750	●
1 1/4- 7	H7/H8	1.095 - 1.123	4	1.021	0.766	5.748	N/A	31.750	9039460317500	●
1 3/8- 6	H7/H8	1.195 - 1.225	5	1.108	0.831	6.063	N/A	34.925	9039460349250	●
1 1/2-6	H7/H8	1.320 - 1.350	5	1.233	0.925	6.378	N/A	38.100	9039460381000	●

UNC

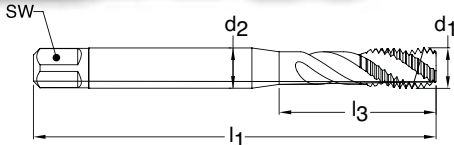

Blind holes



TiCN coated



External cooling

Series 3949
Standard ANSI
Tool Material HSS-E (Cobalt)
Spiral Flute 40° Helix
Chamfer Form C • 2-3
Class of Fit 2B

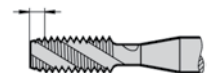

d1 - P	H Limits	Tap Drill Range inch	Number of Flutes	d2 inch	SW inch	l1 inch	l3 inch	Order Code	EDP Number	Stock
2-56	H2/H3	0.067 - 0.074	3	0.141	0.110	1.752	0.441	2.184	9039490021840	●
3-48	H2/H3	0.076 - 0.084	3	0.141	0.110	1.811	0.500	2.515	9039490025150	●
4-40	H2/H3	0.085 - 0.094	3	0.141	0.110	1.882	0.709	2.845	9039490028450	●
5-40	H2/H3	0.098 - 0.106	3	0.141	0.110	1.941	0.709	3.175	9039490031750	●
6-32	H3/H4	0.104 - 0.114	3	0.141	0.110	2.000	0.748	3.505	9039490035050	●
8-32	H3/H4	0.130 - 0.139	3	0.168	0.131	2.130	0.827	4.166	9039490041660	●
10-24	H3/H4	0.145 - 0.155	3	0.194	0.152	2.382	0.945	4.826	9039490048260	●
12-24	H3/H4	0.171 - 0.181	3	0.220	0.165	2.382	1.024	5.486	9039490054860	●
1/4-20	H4/H5	0.196 - 0.207	3	0.255	0.191	2.500	1.181	6.350	9039490063500	●
5/16-18	H4/H5	0.252 - 0.265	3	0.318	0.238	2.721	1.377	7.938	9039490079380	●
3/8-16	H5/H6	0.307 - 0.321	3	0.381	0.286	2.941	1.456	9.525	9039490095250	●
7/16-14	H5/H6	0.360 - 0.376	3	0.323	0.242	3.161	N/A	11.113	9039490111130	●
1/2-13	H5/H6	0.417 - 0.434	3	0.367	0.275	3.382	N/A	12.700	9039490127000	●
9/16-12	H5/H6	0.472 - 0.490	3	0.429	0.322	3.591	N/A	14.288	9039490142880	●
5/8-11	H5/H6	0.527 - 0.546	4	0.480	0.360	3.811	N/A	15.875	9039490158750	●
3/4-10	H5/H6	0.642 - 0.663	4	0.590	0.442	4.252	N/A	19.050	9039490190500	●
7/8-9	H6/H7	0.755 - 0.778	4	0.697	0.523	4.689	N/A	22.225	9039490222250	●
1-8	H6/H7	0.865 - 0.890	4	0.800	0.600	5.130	N/A	25.400	9039490254000	●
1 1/8- 7	H6/H7	0.970 - 0.998	4	0.896	0.672	5.441	N/A	28.575	9039490285750	●
1 1/4- 7	H7/H8	1.095 - 1.123	4	1.021	0.766	5.748	N/A	31.750	9039490317500	●
1 3/8- 6	H7/H8	1.195 - 1.225	4	1.108	0.831	6.063	N/A	34.925	9039490349250	●
1 1/2-6	H7/H8	1.320 - 1.350	6	1.233	0.925	6.378	N/A	38.100	9039490381000	●

UNF

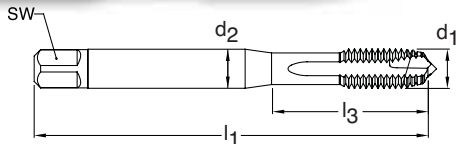

Through holes



TiCN coated



External cooling

Series 3947
Standard ANSI
Tool Material HSS-E (Cobalt)
Spiral Point Straight flute
Chamfer Form B • 3.5 - 5
Class of Fit 2B

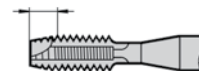

d1 - P	H Limits	Tap Drill Range inch	Number of Flutes	d2 inch	SW inch	l1 inch	l3 inch	Order Code	EDP Number	Stock
2-64	H2/H3	0.069 - 0.075	3	0.141	0.110	1.752	0.441	2.184	9039470021840	●
3-56	H2/H3	0.080 - 0.086	3	0.141	0.110	1.811	0.500	2.515	9039470025150	●
4-48	H2/H3	0.089 - 0.097	3	0.141	0.110	1.882	0.709	2.845	9039470028450	●
5-44	H2/H3	0.100 - 0.108	3	0.141	0.110	1.941	0.709	3.175	9039470031750	●
6-40	H2/H3	0.111 - 0.119	3	0.141	0.110	2.000	0.748	3.505	9039470035050	●
8-36	H2/H3	0.134 - 0.142	3	0.168	0.131	2.130	0.827	4.166	9039470041660	●
10-32	H3/H4	0.156 - 0.164	3	0.194	0.152	2.382	0.945	4.826	9039470048260	●
12-28	H3/H4	0.177 - 0.186	3	0.220	0.165	2.382	1.024	5.486	9039470054860	●
1/4-28	H3/H4	0.211 - 0.220	3	0.255	0.191	2.500	1.181	6.350	9039470063500	●
5/16-24	H3/H4	0.267 - 0.277	3	0.318	0.238	2.721	1.377	7.938	9039470079380	●
3/8-24	H3/H4	0.330 - 0.340	3	0.381	0.286	2.941	1.456	9.525	9039470095250	●
7/16-20	H4/H5	0.383 - 0.395	3	0.323	0.242	3.161	N/A	11.113	9039470111130	●
1/2-20	H4/H5	0.446 - 0.457	4	0.367	0.275	3.382	N/A	12.700	9039470127000	●
9/16-18	H4/H5	0.502 - 0.515	4	0.429	0.322	3.591	N/A	14.288	9039470142880	●
5/8-18	H4/H5	0.565 - 0.578	4	0.480	0.360	3.811	N/A	15.875	9039470158750	●
3/4-16	H5/H6	0.682 - 0.696	4	0.590	0.442	4.252	N/A	19.050	9039470190500	●
7/8-14	H6/H7	0.798 - 0.813	4	0.697	0.523	4.689	N/A	22.225	9039470222250	●
1-12	H6/H7	0.910 - 0.928	4	0.800	0.600	5.130	N/A	25.400	9039470254000	●
1 1/8- 12	H6/H7	1.035 - 1.053	4	0.896	0.672	5.441	N/A	28.575	9039470285750	●
1 1/4-12	H7/H8	1.160 - 1.178	4	1.021	0.766	5.748	N/A	31.750	9039470317500	●
1 3/8- 12	H7/H8	1.285 - 1.303	6	1.108	0.831	6.063	N/A	34.925	9039470349250	●
1 1/2-12	H7/H8	1.410 - 1.428	6	1.233	0.925	6.378	N/A	38.100	9039470381000	●

UNF

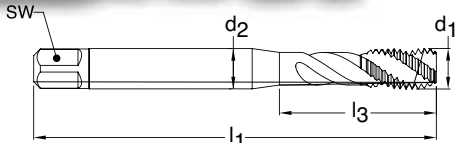

Blind holes



TiCN coated



External cooling

Series 3950
Standard ANSI
Tool Material HSS-E (Cobalt)
Spiral Flute 40° Helix
Chamfer Form C • 2-3
Class of Fit 2B



d1 - P	H Limits	Tap Drill Range inch	Number of Flutes	d2 inch	SW inch	l1 inch	l3 inch	Order Code	EDP Number	Stock
2-64	H2/H3	0.069 - 0.075	3	0.141	0.110	1.752	0.441	2.184	9039500021840	●
3-56	H2/H3	0.080 - 0.086	3	0.141	0.110	1.811	0.500	2.515	9039500025150	●
4-48	H2/H3	0.089 - 0.097	3	0.141	0.110	1.882	0.709	2.845	9039500028450	●
5-44	H2/H3	0.100 - 0.108	3	0.141	0.110	1.941	0.709	3.175	9039500031750	●
6-40	H2/H3	0.111 - 0.119	3	0.141	0.110	2.000	0.748	3.505	9039500035050	●
8-36	H2/H3	0.134 - 0.142	3	0.168	0.131	2.130	0.827	4.166	9039500041660	●
10-32	H3/H4	0.156 - 0.164	3	0.194	0.152	2.382	0.945	4.826	9039500048260	●
12-28	H3/H4	0.177 - 0.186	3	0.220	0.165	2.382	1.024	5.486	9039500054860	●
1/4-28	H3/H4	0.211 - 0.220	3	0.255	0.191	2.500	1.181	6.350	9039500063500	●
5/16-24	H3/H4	0.267 - 0.277	3	0.318	0.238	2.721	1.377	7.938	9039500079380	●
3/8-24	H3/H4	0.330 - 0.340	3	0.381	0.286	2.941	1.456	9.525	9039500095250	●
7/16-20	H4/H5	0.383 - 0.395	3	0.323	0.242	3.161	N/A	11.113	9039500111130	●
1/2-20	H4/H5	0.446 - 0.457	3	0.367	0.275	3.382	N/A	12.700	9039500127000	●
9/16-18	H4/H5	0.502 - 0.515	3	0.429	0.322	3.591	N/A	14.288	9039500142880	●
5/8-18	H4/H5	0.565 - 0.578	4	0.480	0.360	3.811	N/A	15.875	9039500158750	●
3/4-16	H5/H6	0.682 - 0.696	4	0.590	0.442	4.252	N/A	19.050	9039500190500	●
7/8-14	H6/H7	0.798 - 0.813	4	0.697	0.523	4.689	N/A	22.225	9039500222250	●
1-12	H6/H7	0.910 - 0.928	4	0.800	0.600	5.130	N/A	25.400	9039500254000	●
1 1/8- 12	H6/H7	1.035 - 1.053	4	0.896	0.672	5.441	N/A	28.575	9039500285750	●
1 1/4-12	H6/H7	1.160 - 1.178	4	1.021	0.766	5.748	N/A	31.750	9039500317500	●
1 1/2-12	H6/H7	1.410 - 1.428	6	1.233	0.925	6.378	N/A	38.100	9039500381000	●

"Tap drill Range" given is per the Class of Fit shown per Series #
 Additional Tap Drill sizes & percent of thread engagement can be found on pages 229-237.

UNC - Oversized + 0.003

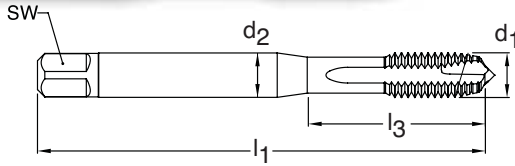

Series 3982
Standard ANSI
Tool Material HSS-E (Cobalt)
Spiral Point Straight flute
Chamfer Form B • 3.5 - 5
Class of Fit H7



 Through holes
 S TiN coated
 External cooling

d1 - P	H Limits	Tap Drill Range inch	Number of Flutes	d2 inch	SW inch	l1 inch	l3 inch	Order Code	EDP Number	Stock
6-32	H7	0.106 - 0.116	3	0.141	0.110	2.000	0.748	3.505	9039820035050	●
8-32	H7	0.132 - 0.141	3	0.168	0.131	2.130	0.827	4.166	9039820041660	●
10-24	H7	0.147 - 0.157	3	0.194	0.152	2.382	0.945	4.826	9039820048260	●
12-24	H7	0.173 - 0.183	3	0.220	0.165	2.382	1.024	5.486	9039820054860	●
1/4-20	H7	0.198 - 0.209	3	0.255	0.191	2.500	1.181	6.350	9039820063500	●
5/16-18	H7	0.253 - 0.266	3	0.318	0.238	2.721	1.377	7.938	9039820079380	●
3/8-16	H7	0.308 - 0.322	3	0.381	0.286	2.941	1.456	9.525	9039820095250	●
7/16-14	H7	0.361 - 0.377	3	0.323	0.242	3.161	N/A	11.113	9039820111130	●
1/2-13	H7	0.418 - 0.435	4	0.367	0.275	3.382	N/A	12.700	9039820127000	●
5/8-11	H7	0.528 - 0.547	4	0.480	0.360	3.811	N/A	15.875	9039820158750	●

UNC - Oversized + 0.003

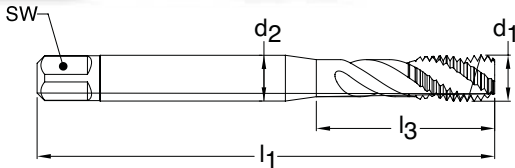

Series 3980
Standard ANSI
Tool Material HSS-E (Cobalt)
Spiral Flute 40° Helix
Chamfer Form C • 2-3
Class of Fit H7

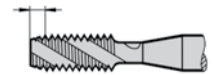

 Blind holes
 S TiN coated
 External cooling

d1 - P	H Limits	Tap Drill Range inch	Number of Flutes	d2 inch	SW inch	l1 inch	l3 inch	Order Code	EDP Number	Stock
6-32	H7	0.106 - 0.116	3	0.141	0.110	2.000	0.748	3.505	9039800035050	●
8-32	H7	0.132 - 0.141	3	0.168	0.131	2.130	0.827	4.166	9039800041660	●
10-24	H7	0.147 - 0.157	3	0.194	0.152	2.382	0.945	4.826	9039800048260	●
12-24	H7	0.173 - 0.183	3	0.220	0.165	2.382	1.024	5.486	9039800054860	●
1/4-20	H7	0.198 - 0.209	3	0.255	0.191	2.500	1.181	6.350	9039800063500	●
5/16-18	H7	0.253 - 0.266	3	0.318	0.238	2.721	1.377	7.938	9039800079380	●
3/8-16	H7	0.308 - 0.322	3	0.381	0.286	2.941	1.456	9.525	9039800095250	●
7/16-14	H7	0.361 - 0.377	3	0.323	0.242	3.161	N/A	11.113	9039800111130	●
1/2-13	H7	0.418 - 0.435	3	0.367	0.275	3.382	N/A	12.700	9039800127000	●
5/8-11	H7	0.528 - 0.547	4	0.480	0.360	3.811	N/A	15.875	9039800158750	●

TECH TIP: Oversized pitch Ø taps

Due to varied machining capabilities and manufacturing processes there are times that a customer will be looking for a tap with what is considered to be an oversized pitch diameter. Most of these cases involve either some form of plating or over-coating being applied to the manufactured part or a heat treatment process that would cause some material shrinkage. Guhring now offers you a Standard Fractional offering option of +0.003" or +0.005" and a Metric offering with +0.003".

UNF - Oversized + 0.003

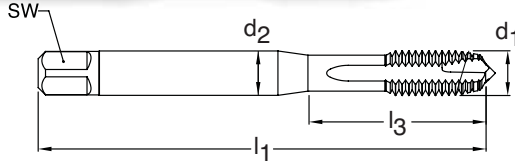

Series 3983
Standard ANSI
Tool Material HSS-E (Cobalt)
Spiral Point Straight flute
Chamfer Form B • 3.5 - 5
Class of Fit H7



 Through holes
 S TiN coated
 External cooling

d1 - P	H Limits	Tap Drill Range inch	Number of Flutes	d2 inch	SW inch	l1 inch	l3 inch	Order Code	EDP Number	Stock
6-40	H7	0.113 - 0.121	3	0.141	0.110	2.000	0.748	3.505	9039830035050	●
8-36	H7	0.136 - 0.144	3	0.168	0.131	2.130	0.827	4.166	9039830041660	●
10-32	H7	0.156 - 0.164	3	0.194	0.152	2.382	0.945	4.826	9039830048260	●
12-28	H7	0.179 - 0.188	3	0.220	0.165	2.382	1.024	5.486	9039830054860	●
1/4-28	H7	0.213 - 0.222	3	0.255	0.191	2.500	1.181	6.350	9039830063500	●
5/16-24	H7	0.269 - 0.279	3	0.318	0.238	2.721	1.377	7.938	9039830079380	●
3/8-24	H7	0.332 - 0.342	3	0.381	0.286	2.941	1.456	9.525	9039830095250	●
7/16-20	H7	0.384 - 0.396	3	0.323	0.242	3.161	N/A	11.113	9039830111130	●
1/2-20	H7	0.447 - 0.458	4	0.367	0.275	3.382	N/A	12.700	9039830127000	●
5/8-18	H7	0.566 - 0.579	4	0.480	0.360	3.811	N/A	15.875	9039830158750	●

UNF - Oversized + 0.003

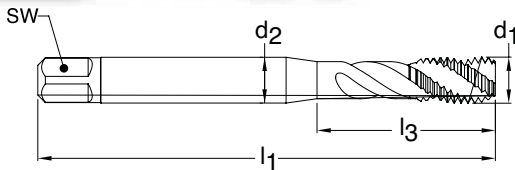

Series 3981
Standard ANSI
Tool Material HSS-E (Cobalt)
Spiral Flute 40° Helix
Chamfer Form C • 2-3
Class of Fit H7

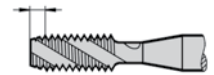

 Blind holes
 S TiN coated
 External cooling

d1 - P	H Limits	Tap Drill Range inch	Number of Flutes	d2 inch	SW inch	l1 inch	l3 inch	Order Code	EDP Number	Stock
6-40	H7	0.113 - 0.121	3	0.141	0.110	2.000	0.748	3.505	9039810035050	●
8-36	H7	0.136 - 0.144	3	0.168	0.131	2.130	0.827	4.166	9039810041660	●
10-32	H7	0.156 - 0.164	3	0.194	0.152	2.382	0.945	4.826	9039810048260	●
12-28	H7	0.179 - 0.188	3	0.220	0.165	2.382	1.024	5.486	9039810054860	●
1/4-28	H7	0.213 - 0.222	3	0.255	0.191	2.500	1.181	6.350	9039810063500	●
5/16-24	H7	0.269 - 0.279	3	0.318	0.238	2.721	1.377	7.938	9039810079380	●
3/8-24	H7	0.332 - 0.342	3	0.381	0.286	2.941	1.456	9.525	9039810095250	●
7/16-20	H7	0.384 - 0.396	3	0.323	0.242	3.161	N/A	11.113	9039810111130	●
1/2-20	H7	0.447 - 0.458	3	0.367	0.275	3.382	N/A	12.700	9039810127000	●
5/8-18	H7	0.566 - 0.579	4	0.480	0.360	3.811	N/A	15.875	9039810158750	●

"Tap drill Range" given is per the Class of Fit shown per Series #
 Additional Tap Drill sizes & percent of thread engagement can be found on pages 229-237.

UNC - Oversized + 0.005

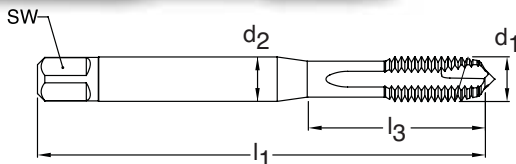

Series 3986
Standard ANSI
Tool Material HSS-E (Cobalt)
Spiral Point Straight flute
Chamfer Form B • 3.5 - 5
Class of Fit H11

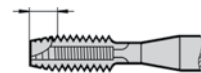

Through holes **TiN coated** **External cooling**

d1 - P	H Limits	Tap Drill Range inch	Number of Flutes	d2 inch	SW inch	l1 inch	l3 inch	Order Code	EDP Number	Stock
6-32	H11	0.108 - 0.118	3	0.141	0.110	2.000	0.748	3.505	9039860035050	●
8-32	H11	0.134 - 0.143	3	0.168	0.131	2.130	0.827	4.166	9039860041660	●
10-24	H11	0.149 - 0.159	3	0.194	0.152	2.382	0.945	4.826	9039860048260	●
12-24	H11	0.175 - 0.185	3	0.220	0.165	2.382	1.024	5.486	9039860054860	●
1/4-20	H11	0.199 - 0.210	3	0.255	0.191	2.500	1.181	6.350	9039860063500	●
5/16-18	H11	0.255 - 0.268	3	0.318	0.238	2.721	1.377	7.938	9039860079380	●
3/8-16	H11	0.310 - 0.324	3	0.381	0.286	2.941	1.456	9.525	9039860095250	●
7/16-14	H11	0.363 - 0.379	3	0.323	0.242	3.161	N/A	11.113	9039860111130	●
1/2-13	H11	0.420 - 0.437	4	0.367	0.275	3.382	N/A	12.700	9039860127000	●
5/8-11	H11	0.530 - 0.549	4	0.480	0.360	3.811	N/A	15.875	9039860158750	●

UNC - Oversized + 0.005

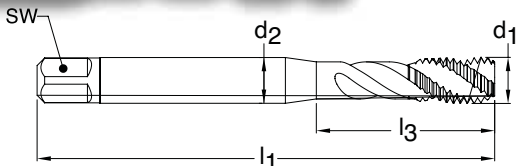

Series 3984
Standard ANSI
Tool Material HSS-E (Cobalt)
Spiral Flute 40° Helix
Chamfer Form C • 2-3
Class of Fit H11



Blind holes **TiN coated** **External cooling**

d1 - P	H Limits	Tap Drill Range inch	Number of Flutes	d2 inch	SW inch	l1 inch	l3 inch	Order Code	EDP Number	Stock
6-32	H11	0.108 - 0.118	3	0.141	0.110	2.000	0.748	3.505	9039840035050	●
8-32	H11	0.134 - 0.143	3	0.168	0.131	2.130	0.827	4.166	9039840041660	●
10-24	H11	0.149 - 0.159	3	0.194	0.152	2.382	0.945	4.826	9039840048260	●
12-24	H11	0.175 - 0.185	3	0.220	0.165	2.382	1.024	5.486	9039840054860	●
1/4-20	H11	0.199 - 0.210	3	0.255	0.191	2.500	1.181	6.350	9039840063500	●
5/16-18	H11	0.255 - 0.268	3	0.318	0.238	2.721	1.377	7.938	9039840079380	●
3/8-16	H11	0.310 - 0.324	3	0.381	0.286	2.941	1.456	9.525	9039840095250	●
7/16-14	H11	0.363 - 0.379	3	0.323	0.242	3.161	N/A	11.113	9039840111130	●
1/2-13	H11	0.420 - 0.437	3	0.367	0.275	3.382	N/A	12.700	9039840127000	●
5/8-11	H11	0.530 - 0.549	4	0.480	0.360	3.811	N/A	15.875	9039840158750	●

TECH TIP: Oversized pitch Ø taps

Due to varied machining capabilities and manufacturing processes there are times that a customer will be looking for a tap with what is considered to be an oversize pitch diameter. Most of these cases involve either some form of plating or over-coating being applied to the manufactured part or a heat treatment process that would cause some material shrinkage. Guhring now offers you a Standard Fractional offering option of +0.003" or +0.005" and a Metric offering with +0.003".

UNF - Oversized + 0.005

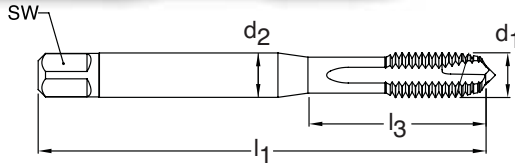

Series 3987
Standard ANSI
Tool Material HSS-E (Cobalt)
Spiral Point Straight flute
Chamfer Form B • 3.5 - 5
Class of Fit H11



Through holes

TiN coated

External cooling

d1 - P	H Limits	Tap Drill Range inch	Number of Flutes	d2 inch	SW inch	l1 inch	l3 inch	Order Code	EDP Number	Stock
6-40	H11	0.115 - 0.123	3	0.141	0.110	2.000	0.748	3.505	9039870035050	●
8-36	H11	0.138 - 0.146	3	0.168	0.131	2.130	0.827	4.166	9039870041660	●
10-32	H11	0.160 - 0.168	3	0.194	0.152	2.382	0.945	4.826	9039870048260	●
12-28	H11	0.181 - 0.190	3	0.220	0.165	2.382	1.024	5.486	9039870054860	●
1/4-28	H11	0.215 - 0.224	3	0.255	0.191	2.500	1.181	6.350	9039870063500	●
5/16-24	H11	0.271 - 0.281	3	0.318	0.238	2.721	1.377	7.938	9039870079380	●
3/8-24	H11	0.334 - 0.344	3	0.381	0.286	2.941	1.456	9.525	9039870095250	●
7/16-20	H11	0.386 - 0.398	3	0.323	0.242	3.161	N/A	11.113	9039870111130	●
1/2-20	H11	0.449 - 0.460	4	0.367	0.275	3.382	N/A	12.700	9039870127000	●
5/8-18	H11	0.568 - 0.581	4	0.480	0.360	3.811	N/A	15.875	9039870158750	●

UNF - Oversized + 0.005

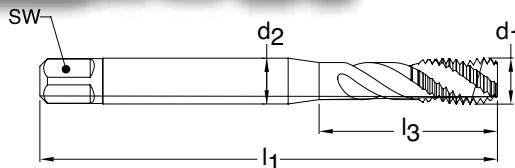

Series 3985
Standard ANSI
Tool Material HSS-E (Cobalt)
Spiral Flute 40° Helix
Chamfer Form C • 2-3
Class of Fit H11

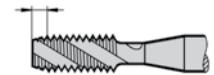

Blind holes

TiN coated

External cooling

d1 - P	H Limits	Tap Drill Range inch	Number of Flutes	d2 inch	SW inch	l1 inch	l3 inch	Order Code	EDP Number	Stock
6-40	H11	0.115 - 0.123	3	0.141	0.110	2.000	0.748	3.505	9039850035050	●
8-36	H11	0.138 - 0.146	3	0.168	0.131	2.130	0.827	4.166	9039850041660	●
10-32	H11	0.160 - 0.168	3	0.194	0.152	2.382	0.945	4.826	9039850048260	●
12-28	H11	0.181 - 0.190	3	0.220	0.165	2.382	1.024	5.486	9039850054860	●
1/4-28	H11	0.215 - 0.224	3	0.255	0.191	2.500	1.181	6.350	9039850063500	●
5/16-24	H11	0.271 - 0.281	3	0.318	0.238	2.720	1.377	7.938	9039850079380	●
3/8-24	H11	0.334 - 0.344	3	0.381	0.286	2.941	1.456	9.525	9039850095250	●
7/16-20	H11	0.386 - 0.398	3	0.323	0.242	3.157	N/A	11.113	9039850111130	●
1/2-20	H11	0.449 - 0.460	3	0.367	0.275	3.381	N/A	12.700	9039850127000	●
5/8-18	H11	0.568 - 0.581	4	0.480	0.360	3.811	N/A	15.875	9039850158750	●

UNC

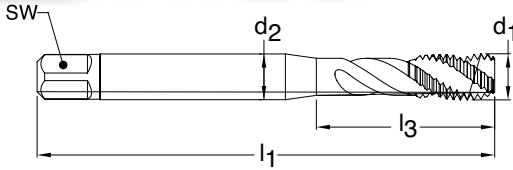

Series 3977

Standard ANSI

Tool Material HSS-E (Cobalt)

Spiral Flute 40° Helix

Chamfer Form E • 1.5-2

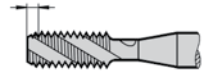

Class of Fit 2B



Blind holes



TiN coated



External cooling

d1 - P	H Limits	Tap Drill Range inch	Number of Flutes	d2 inch	SW inch	l1 inch	l3 inch	Order Code	EDP Number	Stock
2-56	H2/H3	0.067 - 0.074	3	0.141	0.110	1.752	0.441	2.184	9039770021840	●
3-48	H2/H3	0.076 - 0.084	3	0.141	0.110	1.811	0.500	2.515	9039770025150	●
4-40	H2/H3	0.085 - 0.094	3	0.141	0.110	1.882	0.709	2.845	9039770028450	●
5-40	H2/H3	0.098 - 0.106	3	0.141	0.110	1.941	0.709	3.175	9039770031750	●
6-32	H3/H4	0.104 - 0.114	3	0.141	0.110	2.000	0.748	3.505	9039770035050	●
8-32	H3/H4	0.130 - 0.139	3	0.168	0.131	2.130	0.827	4.166	9039770041660	●
10-24	H3/H4	0.145 - 0.155	3	0.194	0.152	2.382	0.945	4.826	9039770048260	●
12-24	H3/H4	0.171 - 0.181	3	0.220	0.165	2.382	1.024	5.486	9039770054860	●
1/4-20	H4/H5	0.196 - 0.207	3	0.255	0.191	2.500	1.181	6.350	9039770063500	●
5/16-18	H4/H5	0.252 - 0.265	3	0.318	0.238	2.721	1.377	7.938	9039770079380	●
3/8-16	H5/H6	0.307 - 0.321	3	0.381	0.286	2.941	1.456	9.525	9039770095250	●
7/16-14	H5/H6	0.360 - 0.376	3	0.323	0.242	3.161	N/A	11.113	9039770111130	●
1/2-13	H5/H6	0.417 - 0.434	3	0.367	0.275	3.382	N/A	12.700	9039770127000	●
9/16-12	H5/H6	0.472 - 0.490	3	0.429	0.322	3.591	N/A	14.288	9039770142880	●
5/8-11	H5/H6	0.527 - 0.546	4	0.480	0.360	3.811	N/A	15.875	9039770158750	●
3/4-10	H5/H6	0.642 - 0.663	4	0.590	0.442	4.252	N/A	19.050	9039770190500	●
7/8-9	H6/H7	0.755 - 0.778	4	0.697	0.523	4.689	N/A	22.225	9039770222250	●
1-8	H6/H7	0.865 - 0.890	4	0.800	0.600	5.130	N/A	25.400	9039770254000	●
1 1/4-7	H7/H8	1.095 - 1.123	4	1.021	0.766	5.748	N/A	31.750	9039770317500	●
1 1/2-6	H7/H8	1.320 - 1.350	6	1.233	0.925	6.378	N/A	38.100	9039770381000	●

UNF

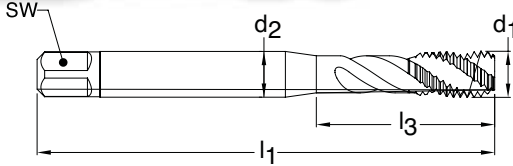

Series 3978

Standard ANSI

Tool Material HSS-E (Cobalt)

Spiral Flute 40° Helix

Chamfer Form E • 1.5-2

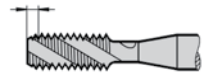

Class of Fit 2B



Blind holes



TiN coated



External cooling

d1 - P	H Limits	Tap Drill Range inch	Number of Flutes	d2 inch	SW inch	l1 inch	l3 inch	Order Code	EDP Number	Stock
2-64	H2/H3	0.069 - 0.075	3	0.141	0.110	1.752	0.441	2.184	9039780021840	●
3-56	H2/H3	0.080 - 0.086	3	0.141	0.110	1.811	0.500	2.515	9039780025150	●
4-48	H2/H3	0.089 - 0.097	3	0.141	0.110	1.882	0.709	2.845	9039780028450	●
5-44	H2/H3	0.100 - 0.108	3	0.141	0.110	1.941	0.709	3.175	9039780031750	●
6-40	H2/H3	0.111 - 0.119	3	0.141	0.110	2.000	0.748	3.505	9039780035050	●
8-36	H2/H3	0.134 - 0.142	3	0.168	0.131	2.130	0.827	4.166	9039780041660	●
10-32	H3/H4	0.156 - 0.164	3	0.194	0.152	2.382	0.945	4.826	9039780048260	●
12-28	H3/H4	0.177 - 0.186	3	0.220	0.165	2.382	1.024	5.486	9039780054860	●
1/4-28	H3/H4	0.211 - 0.220	3	0.255	0.191	2.500	1.181	6.350	9039780063500	●
5/16-24	H3/H4	0.267 - 0.277	3	0.318	0.238	2.721	1.377	7.938	9039780079380	●
3/8-24	H3/H4	0.330 - 0.340	3	0.381	0.286	2.941	1.456	9.525	9039780095250	●
7/16-20	H4/H5	0.383 - 0.395	3	0.323	0.242	3.161	N/A	11.113	9039780111130	●
1/2-20	H4/H5	0.446 - 0.457	3	0.367	0.275	3.382	N/A	12.700	9039780127000	●
9/16-18	H4/H5	0.502 - 0.515	3	0.429	0.322	3.591	N/A	14.288	9039780142880	●
5/8-18	H4/H5	0.565 - 0.578	4	0.480	0.360	3.811	N/A	15.875	9039780158750	●
3/4-16	H5/H6	0.682 - 0.696	4	0.590	0.442	4.252	N/A	19.050	9039780190500	●
7/8-14	H6/H7	0.798 - 0.813	4	0.697	0.523	4.689	N/A	22.225	9039780222250	●
1-12	H6/H7	0.910 - 0.928	4	0.800	0.600	5.130	N/A	25.400	9039780254000	●
1 1/4-12	H6/H7	1.160 - 1.178	4	1.021	0.766	5.748	N/A	31.750	9039780317500	●
1 1/2-12	H6/H7	1.410 - 1.428	6	1.233	0.925	6.378	N/A	38.100	9039780381000	●

UNC

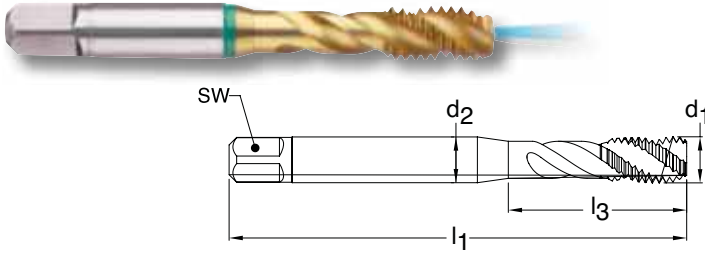

Series 3954
Standard ANSI
Tool Material HSS-E (Cobalt)
Spiral Flute 40° Helix
Chamfer Form C • 2-3
Class of Fit 2B

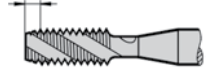

Blind holes



TiN coated



Axial coolant

d1 - P	H Limits	Tap Drill Range inch	Number of Flutes	d2 inch	SW inch	l1 inch	l3 inch	Order Code	EDP Number	Stock
1/4-20	H4/H5	0.196 - 0.207	3	0.255	0.191	2.500	1.181	6.350	9039540063500	●
5/16-18	H4/H5	0.252 - 0.265	3	0.318	0.238	2.721	1.377	7.938	9039540079380	●
3/8-16	H5/H6	0.307 - 0.321	3	0.381	0.286	2.941	1.456	9.525	9039540095250	●
7/16-14	H5/H6	0.360 - 0.376	3	0.323	0.242	3.161	N/A	11.113	9039540111130	●
1/2-13	H5/H6	0.417 - 0.434	3	0.367	0.275	3.382	N/A	12.700	9039540127000	●
5/8-11	H5/H6	0.527 - 0.546	4	0.480	0.360	3.811	N/A	15.875	9039540158750	●
3/4-10	H5/H6	0.642 - 0.663	4	0.590	0.442	4.252	N/A	19.050	9039540190500	●

UNF



Series 3955
Standard ANSI
Chamfer Form C • 2-3
Class of Fit 2B

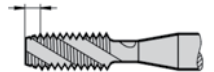

Blind holes



TiN coated



Axial coolant

d1 - P	H Limits	Tap Drill Range inch	Number of Flutes	d2 inch	SW inch	l1 inch	l3 inch	Order Code	EDP Number	Stock
1/4-28	H3/H4	0.211 - 0.220	3	0.255	0.191	2.500	1.181	6.350	9039550063500	●
5/16-24	H3/H4	0.267 - 0.277	3	0.318	0.238	2.721	1.377	7.938	9039550079380	●
3/8-24	H3/H4	0.330 - 0.340	3	0.381	0.286	2.941	1.456	9.525	9039550095250	●
7/16-20	H4/H5	0.383 - 0.395	3	0.323	0.242	3.161	N/A	11.113	9039550111130	●
1/2-20	H4/H5	0.446 - 0.457	3	0.367	0.275	3.382	N/A	12.700	9039550127000	●
5/8-18	H4/H5	0.565 - 0.578	4	0.480	0.360	3.811	N/A	15.875	9039550158750	●
3/4-16	H5/H6	0.682 - 0.696	4	0.590	0.442	4.252	N/A	19.050	9039550190500	●

UNC Extended length taps - 4" OAL

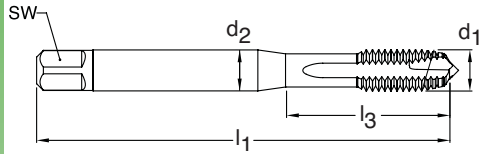

Series 4390
Standard ANSI
Tool Material HSS-E (Cobalt)
Spiral Point Straight flute
Chamfer Form B • 3.5 - 5
Class of Fit 2B

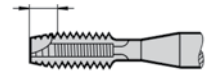

Through holes



TiN coated



External cooling

d1 - P	H Limits	Tap Drill Range inch	Number of Flutes	d2 inch	SW inch	l1 inch	l3 inch	Order Code	EDP Number	Stock
4-40	H2/H3	0.085 - 0.094	3	0.141	0.110	4.00	2.000	2.845	9043900028450	●
6-32	H3/H4	0.104 - 0.114	3	0.141	0.110	4.00	2.000	3.505	9043900035050	●
8-32	H3/H4	0.130 - 0.139	3	0.168	0.131	4.00	2.000	4.166	9043900041660	●
10-24	H3/H4	0.145 - 0.155	3	0.194	0.152	4.00	2.000	4.826	9043900048260	●
1/4-20	H4/H5	0.196 - 0.207	3	0.255	0.191	4.00	2.000	6.350	9043900063500	●

UNC Extended length taps - 4" OAL

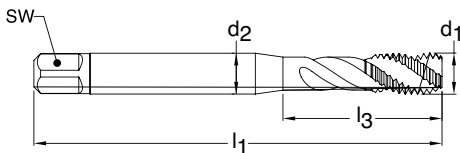

Series 4283
Standard ANSI
Tool Material HSS-E (Cobalt)
Spiral Point 40° Helix
Chamfer Form C • 2-3
Class of Fit 2B



Blind holes



TiN coated



External cooling

d1 - P	H Limits	Tap Drill Range inch	Number of Flutes	d2 inch	SW inch	l1 inch	l3 inch	Order Code	EDP Number	Stock
4-40	H2/H3	0.085 - 0.094	3	0.141	0.110	4.00	2.000	2.845	9042830028450	●
6-32	H3/H4	0.104 - 0.114	3	0.141	0.110	4.00	2.000	3.505	9042830035050	●
8-32	H3/H4	0.130 - 0.139	3	0.168	0.131	4.00	2.000	4.166	9042830041660	●
10-24	H3/H4	0.145 - 0.155	3	0.194	0.152	4.00	2.000	4.826	9042830048260	●
1/4-20	H4/H5	0.196 - 0.207	3	0.255	0.191	4.00	2.000	6.350	9042830063500	●

UNF Extended length taps - 4" OAL

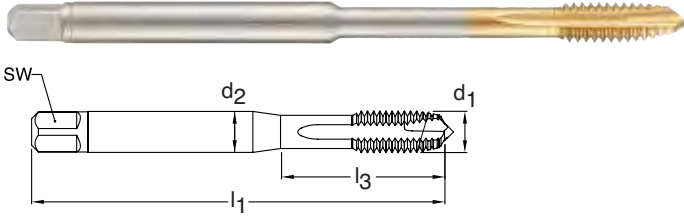

Series 4282
Standard ANSI
Tool Material HSS-E (Cobalt)
Spiral Point Straight flute
Chamfer Form B • 3.5 - 5
Class of Fit 2B



Through holes



TiN coated



External cooling

d1 - P	H Limits	Tap Drill Range inch	Number of Flutes	d2 inch	SW inch	l1 inch	l3 inch	Order Code	EDP Number	Stock
4-48	H2/H3	0.089 - 0.097	3	0.141	0.110	4.00	2.000	2.845	9042820028450	●
6-40	H2/H3	0.111 - 0.119	3	0.141	0.110	4.00	2.000	3.505	9042820035050	●
8-36	H2/H3	0.134 - 0.142	3	0.168	0.131	4.00	2.000	4.166	9042820041660	●
10-32	H3/H4	0.156 - 0.164	3	0.194	0.152	4.00	2.000	4.826	9042820048260	●
1/4-28	H3/H4	0.211 - 0.220	3	0.255	0.191	4.00	2.000	6.350	9042820063500	●

UNF Extended length taps - 4" OAL

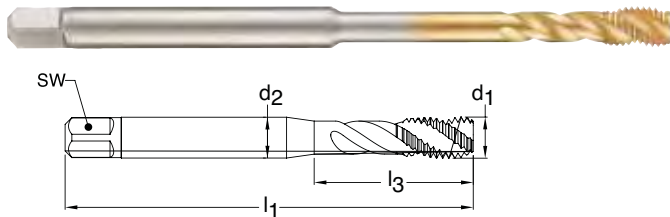

Series 4284
Standard ANSI
Tool Material HSS-E (Cobalt)
Spiral Point 40° Helix
Chamfer Form C • 2-3
Class of Fit 2B

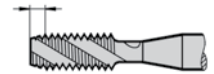

Blind holes



TiN coated



External cooling

d1 - P	H Limits	Tap Drill Range inch	Number of Flutes	d2 inch	SW inch	l1 inch	l3 inch	Order Code	EDP Number	Stock
4-48	H2/H3	0.089 - 0.097	3	0.141	0.110	4.00	2.000	2.845	9042840028450	●
6-40	H2/H3	0.111 - 0.119	3	0.141	0.110	4.00	2.000	3.505	9042840035050	●
8-36	H2/H3	0.134 - 0.142	3	0.168	0.131	4.00	2.000	4.166	9042840041660	●
10-32	H3/H4	0.156 - 0.164	3	0.194	0.152	4.00	2.000	4.826	9042840048260	●
1/4-28	H3/H4	0.211 - 0.220	3	0.255	0.191	4.00	2.000	6.350	9042840063500	●

UNC Extended length taps - 6" OAL

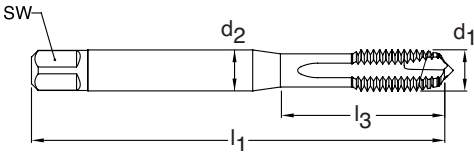

Through holes



TiN coated



External cooling

Series 4285
Standard ANSI
Tool Material HSS-E (Cobalt)
Spiral Point Straight flute
Chamfer Form B • 3.5 - 5
Class of Fit 2B



d1 - P	H Limits	Tap Drill Range inch	Number of Flutes	d2 inch	SW inch	l1 inch	l3 inch	Order Code	EDP Number	Stock
1/4-20	H4/H5	0.196 - 0.207	3	0.255	0.191	6.00	4.000	6.350	9042850063500	●
5/16-18	H4/H5	0.252 - 0.265	3	0.318	0.238	6.00	4.000	7.938	9042850079380	●
3/8-16	H5/H6	0.307 - 0.321	3	0.381	0.286	6.00	4.000	9.525	9042850095250	●
7/16-14	H5/H6	0.360 - 0.376	3	0.323	0.242	6.00	N/A	11.113	9042850111130	●
1/2-13	H5/H6	0.417 - 0.434	4	0.367	0.275	6.00	N/A	12.700	9042850127000	●
9/16-12	H5/H6	0.472 - 0.490	4	0.429	0.322	6.00	N/A	14.288	9042850142880	●
5/8-11	H5/H6	0.527 - 0.546	4	0.480	0.360	6.00	N/A	15.875	9042850158750	●
3/4-10	H5/H6	0.642 - 0.663	4	0.590	0.442	6.00	N/A	19.050	9042850190500	●

UNC Extended length taps - 6" OAL

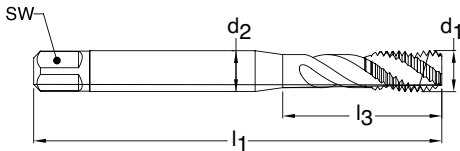

Blind holes



TiN coated



External cooling

Series 4287
Standard ANSI
Tool Material HSS-E (Cobalt)
Spiral Point 40° Helix
Chamfer Form C • 2-3
Class of Fit 2B

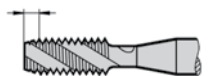

d1 - P	H Limits	Tap Drill Range inch	Number of Flutes	d2 inch	SW inch	l1 inch	l3 inch	Order Code	EDP Number	Stock
1/4-20	H4/H5	0.196 - 0.207	3	0.255	0.191	6.00	4.000	6.350	9042870063500	●
5/16-18	H4/H5	0.252 - 0.265	3	0.318	0.238	6.00	4.000	7.938	9042870079380	●
3/8-16	H5/H6	0.307 - 0.321	3	0.381	0.286	6.00	4.000	9.525	9042870095250	●
7/16-14	H5/H6	0.360 - 0.376	3	0.323	0.242	6.00	N/A	11.113	9042870111130	●
1/2-13	H5/H6	0.417 - 0.434	3	0.367	0.275	6.00	N/A	12.700	9042870127000	●
9/16-12	H5/H6	0.472 - 0.490	3	0.429	0.322	6.00	N/A	14.288	9042870142880	●
5/8-11	H5/H6	0.527 - 0.546	4	0.480	0.360	6.00	N/A	15.875	9042870158750	●
3/4-10	H5/H6	0.642 - 0.663	4	0.590	0.442	6.00	N/A	19.050	9042870190500	●

UNF Extended length taps - 6" OAL

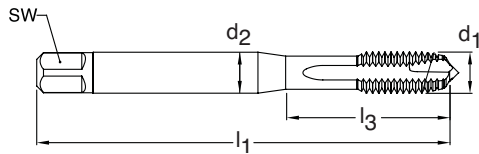

Series 4286
Standard ANSI
Tool Material HSS-E (Cobalt)
Spiral Point Straight flute
Chamfer Form B • 3.5 - 5
Class of Fit 2B



Through holes

TiN coated

External cooling

d1 - P	H Limits	Tap Drill Range inch	Number of Flutes	d2 inch	SW inch	l1 inch	l3 inch	Order Code	EDP Number	Stock
1/4-28	H3/H4	0.211 - 0.220	3	0.255	0.191	6.00	4.000	6.350	9042860063500	●
5/16-24	H3/H4	0.267 - 0.277	3	0.318	0.238	6.00	4.000	7.938	9042860079380	●
3/8-24	H3/H4	0.330 - 0.340	3	0.381	0.286	6.00	4.000	9.525	9042860095250	●
7/16-20	H4/H5	0.383 - 0.395	3	0.323	0.242	6.00	N/A	11.113	9042860111130	●
1/2-20	H4/H5	0.446 - 0.457	4	0.367	0.275	6.00	N/A	12.700	9042860127000	●
9/16-18	H4/H5	0.502 - 0.515	4	0.429	0.322	6.00	N/A	14.288	9042860142880	●
5/8-18	H4/H5	0.565 - 0.578	4	0.480	0.360	6.00	N/A	15.875	9042860158750	●
3/4-16	H5/H6	0.682 - 0.696	4	0.590	0.442	6.000	N/A	19.050	9042860190500	●

UNF Extended length taps - 6" OAL

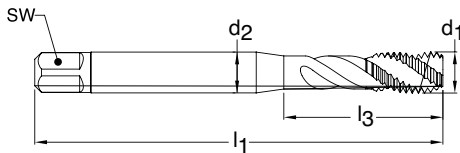

Series 4288
Standard ANSI
Tool Material HSS-E (Cobalt)
Spiral Point 40° Helix
Chamfer Form C • 2-3
Class of Fit 2B

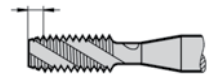

Blind holes

TiN coated

External cooling

d1 - P	H Limits	Tap Drill Range inch	Number of Flutes	d2 inch	SW inch	l1 inch	l3 inch	Order Code	EDP Number	Stock
1/4-28	H3/H4	0.211 - 0.220	3	0.255	0.191	6.00	4.000	6.350	9042880063500	●
5/16-24	H3/H4	0.267 - 0.277	3	0.318	0.238	6.00	4.000	7.938	9042880079380	●
3/8-24	H3/H4	0.330 - 0.340	3	0.381	0.286	6.00	4.000	9.525	9042880095250	●
7/16-20	H4/H5	0.383 - 0.395	3	0.323	0.242	6.00	N/A	11.113	9042880111130	●
1/2-20	H4/H5	0.446 - 0.457	3	0.367	0.275	6.00	N/A	12.700	9042880127000	●
9/16-18	H4/H5	0.502 - 0.515	3	0.429	0.322	6.00	N/A	14.288	9042880142880	●
5/8-18	H4/H5	0.565 - 0.578	4	0.480	0.360	6.00	N/A	15.875	9042880158750	●
3/4-16	H5/H6	0.682 - 0.696	4	0.590	0.442	6.00	N/A	19.050	9042880190500	●

Universal Applications - Alloyed & Unalloyed Steels

UNC / STI

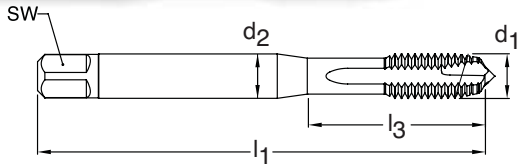

Series 3990
Standard ANSI
Tool Material HSS-E (Cobalt)
Spiral Point Straight flute
Chamfer Form B • 3.5 - 5
Class of Fit 3B STI



Through holes



TiN coated



External cooling

d1 - P	H Limits	Tap Drill Range Inch	Number of Flutes	d2 inch	SW inch	l1 inch	l3 inch	Order Code	EDP Number	Stock
4-40	H2/H3	0.118 - 0.125	3	0.141	0.110	2.000	0.748	2.845	9039900028450	●
6-32	H3/H4	0.145 - 0.153	3	0.194	0.152	2.374	0.945	3.505	9039900035050	●
8-32	H3/H4	0.171 - 0.178	3	0.220	0.165	2.374	1.024	4.166	9039900041660	●
10-24	H3/H4	0.199 - 0.208	3	0.255	0.191	2.500	1.181	4.826	9039900048260	●
1/4-20	H4/H5	0.261 - 0.270	3	0.318	0.238	2.721	1.377	6.350	9039900063500	●
5/16-18	H4/H5	0.324 - 0.334	3	0.381	0.286	2.937	1.456	7.938	9039900079380	●
3/8-16	H5/H6	0.389 - 0.399	3	0.367	0.275	3.374	N/A	9.525	9039900095250	●
1/2-13	H5/H6	0.517 - 0.527	4	0.480	0.360	3.811	N/A	12.700	9039900127000	●

UNC / STI

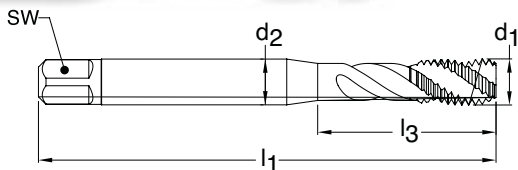

Series 3988
Standard ANSI
Tool Material HSS-E (Cobalt)
Spiral Flute 40° Helix
Chamfer Form C • 2-3
Class of Fit 3B STI



Blind holes



TiN coated



External cooling

d1 - P	H Limits	Tap Drill Range Inch	Number of Flutes	d2 inch	SW inch	l1 inch	l3 inch	Order Code	EDP Number	Stock
4-40	H2/H3	0.118 - 0.125	3	0.141	0.110	2.000	0.748	2.845	9039880028450	●
6-32	H3/H4	0.145 - 0.153	3	0.194	0.152	2.374	0.945	3.505	9039880035050	●
8-32	H3/H4	0.171 - 0.178	3	0.220	0.165	2.374	1.024	4.166	9039880041660	●
10-24	H3/H4	0.199 - 0.208	3	0.255	0.191	2.500	1.181	4.826	9039880048260	●
1/4-20	H4/H5	0.261 - 0.270	3	0.318	0.238	2.721	1.377	6.350	9039880063500	●
5/16-18	H4/H5	0.324 - 0.334	3	0.381	0.286	2.937	1.456	7.938	9039880079380	●
3/8-16	H5/H6	0.389 - 0.399	3	0.367	0.275	3.374	N/A	9.525	9039880095250	●
1/2-13	H5/H6	0.517 - 0.527	4	0.480	0.360	3.811	N/A	12.700	9039880127000	●

TECH TIP: Heli-Coil or STI Taps

An STI Tap is designed to create an oversized, threaded hole so it can accommodate the required Heli-Coil insert. Screw Thread Inserts are helically formed coils of diamond-shaped stainless steel or Phosphorous bronze wire that screw into a threaded hole to form a mating internal thread.

Screw Thread Inserts are a convenient way of repairing stripped out threads and are also used to provide stronger threads in soft materials than what can be obtained by directly tapping the base material. Aluminum, zinc die cast, magnesium and even wood are some materials that an STI may be used in.

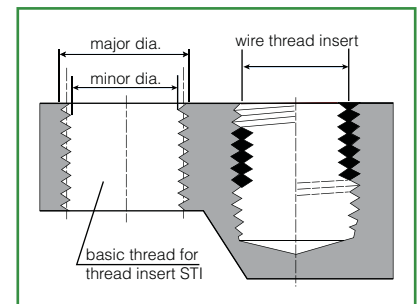

UNF / STI

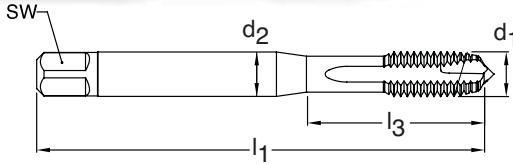

Series 3991
Standard ANSI
Tool Material HSS-E (Cobalt)
Spiral Point Straight flute
Chamfer Form B • 3.5 - 5
Class of Fit 3B STI



Through holes



TiN coated



External cooling

d1 - P	H Limits	Tap Drill Range Inch	Number of Flutes	d2 inch	SW inch	l1 inch	l3 inch	Order Code	EDP Number	Stock
4-48	H2/H3	0.117 - 0.123	3	0.141	0.110	2.000	0.787	2.845	9039910028450	●
6-40	H3/H4	0.143 - 0.150	3	0.168	0.131	2.126	0.984	3.505	9039910035050	●
8-36	H3/H4	0.170 - 0.177	3	0.220	0.165	2.374	1.181	4.166	9039910041660	●
10-32	H3/H4	0.199 - 0.208	3	0.255	0.191	2.500	1.181	4.826	9039910048260	●
1/4-28	H3/H4	0.258 - 0.265	3	0.318	0.238	2.721	1.456	6.350	9039910063500	●
5/16-24	H3/H4	0.324 - 0.334	3	0.381	0.286	2.937	1.456	7.938	9039910079380	●
3/8-24	H5/H6	0.384 - 0.391	3	0.323	0.242	3.374	N/A	9.525	9039910095250	●
1/2-20	H5/H6	0.511 - 0.519	4	0.429	0.322	3.594	N/A	12.700	9039910127000	●

UNF / STI

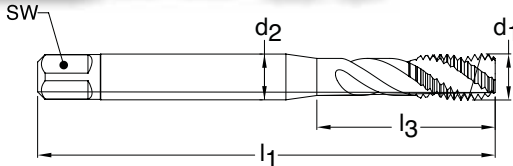

Series 3989
Standard ANSI
Tool Material HSS-E (Cobalt)
Spiral Flute 40° Helix
Chamfer Form C • 2-3
Class of Fit 3B STI

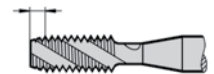

Blind holes



TiN coated



External cooling

d1 - P	H Limits	Tap Drill Range Inch	Number of Flutes	d2 inch	SW inch	l1 inch	l3 inch	Order Code	EDP Number	Stock
4-48	H2/H3	0.117 - 0.123	3	0.141	0.110	2.000	0.787	2.845	9039890028450	●
6-40	H3/H4	0.143 - 0.150	3	0.168	0.131	2.126	0.984	3.505	9039890035050	●
8-36	H3/H4	0.170 - 0.177	3	0.220	0.165	2.374	1.181	4.166	9039890041660	●
10-32	H3/H4	0.199 - 0.208	3	0.255	0.191	2.500	1.181	4.826	9039890048260	●
1/4-28	H3/H4	0.258 - 0.265	3	0.318	0.238	2.721	1.457	6.350	9039890063500	●
5/16-24	H3/H4	0.324 - 0.334	3	0.381	0.286	2.937	1.457	7.938	9039890079380	●
3/8-24	H5/H6	0.384 - 0.391	3	0.323	0.242	3.374	N/A	9.525	9039890095250	●
1/2-20	H5/H6	0.511 - 0.519	4	0.429	0.322	3.594	N/A	12.700	9039890127000	●

"Tap drill Range" given is per the Class of Fit shown per Series #
 Additional Tap Drill sizes & percent of thread engagement can be found on pages 229-237.

METRIC

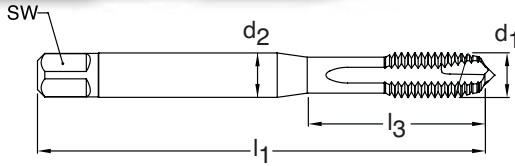

Series 3912
Standard ANSI
Tool Material HSS-E (Cobalt)
Spiral Point Straight flute
Chamfer Form B • 3.5 - 5
Class of Fit ISO 2(6H)

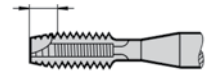

Through holes **Bright finish** **External cooling**

d1 - P	D Limits	Tap Drill Range mm	Number of Flutes	d2 inch	SW inch	l1 inch	l3 inch	Order Code	EDP Number	Stock
M2 X 0.40	D2/D3	1.567 - 1.679	3	0.141	0.110	1.752	0.441	2.000	9039120020000	●
M3 X 0.50	D2/D3	2.459 - 2.599	3	0.141	0.110	1.941	0.709	3.000	9039120030000	●
M4 X 0.70	D3/D4	3.242 - 3.422	3	0.168	0.131	2.130	0.827	4.000	9039120040000	●
M5 X 0.80	D3/D4	4.134 - 4.334	3	0.194	0.152	2.382	0.945	5.000	9039120050000	●
M6 X 1.00	D4/D5	4.917 - 5.153	3	0.255	0.191	2.500	1.181	6.000	9039120060000	●
M8 X 1.25	D4/D5	6.647 - 6.912	3	0.318	0.238	2.721	1.377	8.000	9039120080000	●
M10 X 1.50	D4/D5	8.376 - 8.676	3	0.381	0.286	2.941	1.457	10.000	9039120100000	●
M12 X 1.75	D5/D6	10.106 - 10.441	4	0.367	0.275	3.382	N/A	12.000	9039120120000	●
M14 X 2.00	D5/D6	11.835 - 12.210	4	0.429	0.322	3.591	N/A	14.000	9039120140000	●
M16 X 2.00	D6/D7	13.835 - 14.210	4	0.480	0.360	3.811	N/A	16.000	9039120160000	●
M18 X 2.50	D6/D7	15.294 - 15.744	4	0.542	0.406	4.032	N/A	18.000	9039120180000	●
M20 X 2.50	D6/D7	17.294 - 17.744	4	0.652	0.489	4.469	N/A	20.000	9039120200000	●
M22 X 2.50	D6/D7	19.294 - 19.744	4	0.697	0.523	4.689	N/A	22.000	9039120220000	●
M24 X 3.00	D7/D8	20.752 - 21.252	4	0.760	0.570	4.910	N/A	24.000	9039120240000	●
M30 X 3.50	D7/D8	26.211 - 26.771	4	1.021	0.766	5.433	N/A	30.000	9039120300000	●

METRIC

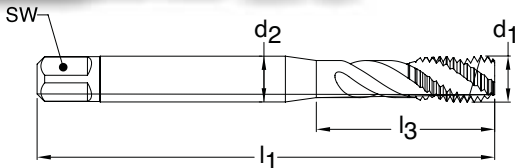

Series 3918
Standard ANSI
Tool Material HSS-E (Cobalt)
Spiral Flute 40° Helix
Chamfer Form C • 2-3
Class of Fit ISO 2(6H)



Blind holes **Bright finish** **External cooling**

d1 - P	D Limits	Tap Drill Range mm	Number of Flutes	d2 inch	SW inch	l1 inch	l3 inch	Order Code	EDP Number	Stock
M2 X 0.40	D2/D3	1.567 - 1.679	3	0.141	0.110	1.752	0.441	2.000	9039180020000	●
M3 X 0.50	D2/D3	2.459 - 2.599	3	0.141	0.110	1.941	0.709	3.000	9039180030000	●
M4 X 0.70	D3/D4	3.242 - 3.422	3	0.168	0.131	2.130	0.827	4.000	9039180040000	●
M5 X 0.80	D3/D4	4.134 - 4.334	3	0.194	0.152	2.382	0.945	5.000	9039180050000	●
M6 X 1.00	D4/D5	4.917 - 5.153	3	0.255	0.191	2.500	1.181	6.000	9039180060000	●
M8 X 1.25	D4/D5	6.647 - 6.912	3	0.318	0.238	2.721	1.377	8.000	9039180080000	●
M10 X 1.50	D4/D5	8.376 - 8.676	3	0.381	0.286	2.941	1.456	10.000	9039180100000	●
M12 X 1.75	D5/D6	10.106 - 10.441	3	0.367	0.275	3.382	N/A	12.000	9039180120000	●
M14 X 2.00	D5/D6	11.835 - 12.210	3	0.429	0.322	3.591	N/A	14.000	9039180140000	●
M16 X 2.00	D6/D7	13.835 - 14.210	4	0.480	0.360	3.811	N/A	16.000	9039180160000	●
M18 X 2.50	D6/D7	15.294 - 15.744	4	0.542	0.406	4.032	N/A	18.000	9039180180000	●
M20 X 2.50	D6/D7	17.294 - 17.744	4	0.652	0.489	4.469	N/A	20.000	9039180200000	●
M22 X 2.50	D6/D7	19.294 - 19.744	4	0.697	0.523	4.689	N/A	22.000	9039180220000	●
M24 X 3.00	D7/D8	20.752 - 21.252	4	0.760	0.570	4.910	N/A	24.000	9039180240000	●
M30 X 3.50	D8/D9	26.211 - 26.771	4	1.021	0.766	5.433	N/A	30.000	9039180300000	●

METRIC

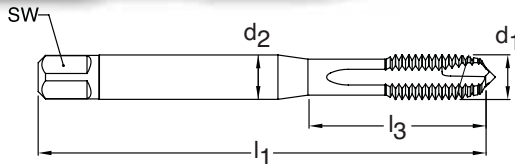

Series 3915
Standard ANSI
Tool Material HSS-E (Cobalt)
Spiral Point Straight flute
Chamfer Form B • 3.5 - 5
Class of Fit ISO 2(6H)

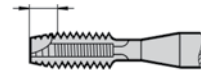

Through holes



TiN coated



External cooling

d1 - P	D Limits	Tap Drill Range mm	Number of Flutes	d2 inch	SW inch	l1 inch	l3 inch	Order Code	EDP Number	Stock
M2 X 0.40	D2/D3	1.567 - 1.679	3	0.141	0.110	1.752	0.441	2.000	9039150020000	●
M3 X 0.50	D2/D3	2.459 - 2.599	3	0.141	0.110	1.941	0.709	3.000	9039150030000	●
M4 X 0.70	D3/D4	3.242 - 3.422	3	0.168	0.131	2.130	0.827	4.000	9039150040000	●
M5 X 0.80	D3/D4	4.134 - 4.334	3	0.194	0.152	2.382	0.945	5.000	9039150050000	●
M6 X 1.00	D4/D5	4.917 - 5.153	3	0.255	0.191	2.500	1.181	6.000	9039150060000	●
M8 X 1.25	D4/D5	6.647 - 6.912	3	0.318	0.238	2.721	1.377	8.000	9039150080000	●
M10 X 1.50	D4/D5	8.376 - 8.676	3	0.381	0.286	2.941	1.457	10.000	9039150100000	●
M12 X 1.75	D5/D6	10.106 - 10.441	4	0.367	0.275	3.382	N/A	12.000	9039150120000	●
M14 X 2.00	D5/D6	11.835 - 12.210	4	0.429	0.322	3.591	N/A	14.000	9039150140000	●
M16 X 2.00	D6/D7	13.835 - 14.210	4	0.480	0.360	3.811	N/A	16.000	9039150160000	●
M18 X 2.50	D6/D7	15.294 - 15.744	4	0.542	0.406	4.032	N/A	18.000	9039150180000	●
M20 X 2.50	D6/D7	17.294 - 17.744	4	0.652	0.489	4.469	N/A	20.000	9039150200000	●
M22 X 2.50	D6/D7	19.294 - 19.744	4	0.697	0.523	4.689	N/A	22.000	9039150220000	●
M24 X 3.00	D7/D8	20.752 - 21.252	4	0.760	0.570	4.910	N/A	24.000	9039150240000	●
M30 X 3.50	D7/D8	26.211 - 26.771	4	1.021	0.766	5.433	N/A	30.000	9039150300000	●

METRIC

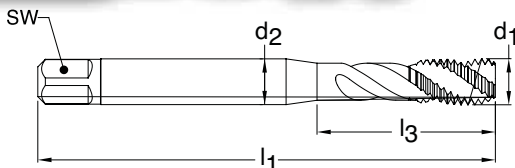

Series 3921
Standard ANSI
Tool Material HSS-E (Cobalt)
Spiral Flute 40° Helix
Chamfer Form C • 2-3
Class of Fit ISO 2(6H)



Blind holes



TiN coated



External cooling

d1 - P	D Limits	Tap Drill Range mm	Number of Flutes	d2 inch	SW inch	l1 inch	l3 inch	Order Code	EDP Number	Stock
M2 X 0.40	D2/D3	1.567 - 1.679	3	0.141	0.110	1.752	0.441	2.000	9039210020000	●
M3 X 0.50	D2/D3	2.459 - 2.599	3	0.141	0.110	1.941	0.709	3.000	9039210030000	●
M4 X 0.70	D3/D4	3.242 - 3.422	3	0.168	0.131	2.130	0.827	4.000	9039210040000	●
M5 X 0.80	D3/D4	4.134 - 4.334	3	0.194	0.152	2.382	0.945	5.000	9039210050000	●
M6 X 1.00	D4/D5	4.917 - 5.153	3	0.255	0.191	2.500	1.181	6.000	9039210060000	●
M8 X 1.25	D4/D5	6.647 - 6.912	3	0.318	0.238	2.721	1.377	8.000	9039210080000	●
M10 X 1.50	D4/D5	8.376 - 8.676	3	0.381	0.286	2.941	1.456	10.000	9039210100000	●
M12 X 1.75	D5/D6	10.106 - 10.441	3	0.367	0.275	3.382	N/A	12.000	9039210120000	●
M14 X 2.00	D5/D6	11.835 - 12.210	3	0.429	0.322	3.591	N/A	14.000	9039210140000	●
M16 X 2.00	D6/D7	13.835 - 14.210	4	0.480	0.360	3.811	N/A	16.000	9039210160000	●
M18 X 2.50	D6/D7	15.294 - 15.744	4	0.542	0.406	4.032	N/A	18.000	9039210180000	●
M20 X 2.50	D6/D7	17.294 - 17.744	4	0.652	0.489	4.469	N/A	20.000	9039210200000	●
M22 X 2.50	D6/D7	19.294 - 19.744	4	0.697	0.523	4.689	N/A	22.000	9039210220000	●
M24 X 3.00	D7/D8	20.752 - 21.252	4	0.760	0.570	4.910	N/A	24.000	9039210240000	●
M30 X 3.50	D8/D9	26.211 - 26.771	4	1.021	0.766	5.433	N/A	30.000	9039210300000	●

"Tap drill Range" given is per the Class of Fit shown per Series #
 Additional Tap Drill sizes & percent of thread engagement can be found on pages 229-237.

METRIC

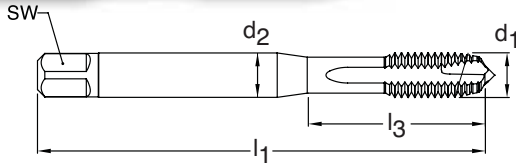

Series 3945
Standard ANSI
Tool Material HSS-E (Cobalt)
Spiral Point Straight flute
Chamfer Form B • 3.5 - 5
Class of Fit ISO 2(6H)



Through holes



TiCN coated



External cooling

d1 - P	D Limits	Tap Drill Range mm	Number of Flutes	d2 inch	SW inch	l1 inch	l3 inch	Order Code	EDP Number	Stock
M2 X 0.40	D2/D3	1.567 - 1.679	3	0.141	0.110	1.752	0.441	2.000	9039450020000	●
M3 X 0.50	D2/D3	2.459 - 2.599	3	0.141	0.110	1.941	0.709	3.000	9039450030000	●
M4 X 0.70	D3/D4	3.242 - 3.422	3	0.168	0.131	2.130	0.827	4.000	9039450040000	●
M5 X 0.80	D3/D4	4.134 - 4.334	3	0.194	0.152	2.382	0.945	5.000	9039450050000	●
M6 X 1.00	D4/D5	4.917 - 5.153	3	0.255	0.191	2.500	1.181	6.000	9039450060000	●
M8 X 1.25	D4/D5	6.647 - 6.912	3	0.318	0.238	2.721	1.377	8.000	9039450080000	●
M10 X 1.50	D4/D5	8.376 - 8.676	3	0.381	0.286	2.941	1.456	10.000	9039450100000	●
M12 X 1.75	D5/D6	10.106 - 10.441	4	0.367	0.275	3.382	N/A	12.000	9039450120000	●
M14 X 2.00	D5/D6	11.835 - 12.210	4	0.429	0.322	3.591	N/A	14.000	9039450140000	●
M16 X 2.00	D6/D7	13.835 - 14.210	4	0.480	0.360	3.811	N/A	16.000	9039450160000	●
M18 X 2.50	D6/D7	15.294 - 15.744	4	0.542	0.406	4.032	N/A	18.000	9039450180000	●
M20 X 2.50	D6/D7	17.294 - 17.744	4	0.652	0.489	4.469	N/A	20.000	9039450200000	●
M22 X 2.50	D6/D7	19.294 - 19.744	4	0.697	0.523	4.689	N/A	22.000	9039450220000	●
M24 X 3.00	D7/D8	20.752 - 21.252	4	0.760	0.570	4.910	N/A	24.000	9039450240000	●
M30 X 3.50	D8/D9	26.211 - 26.771	4	1.021	0.766	5.433	N/A	30.000	9039450300000	●

METRIC

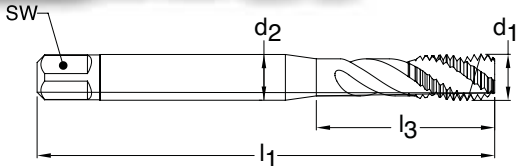

Series 3948
Standard ANSI
Tool Material HSS-E (Cobalt)
Spiral Flute 40° Helix
Chamfer Form C • 2-3
Class of Fit ISO 2(6H)

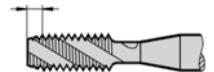

Blind holes



TiCN coated



External cooling

d1 - P	D Limits	Tap Drill Range mm	Number of Flutes	d2 inch	SW inch	l1 inch	l3 inch	Order Code	EDP Number	Stock
M2 X 0.40	D2/D3	1.567 - 1.679	3	0.141	0.110	1.752	0.441	2.000	9039480020000	●
M3 X 0.50	D2/D3	2.459 - 2.599	3	0.141	0.110	1.941	0.709	3.000	9039480030000	●
M4 X 0.70	D3/D4	3.242 - 3.422	3	0.168	0.131	2.130	0.827	4.000	9039480040000	●
M5 X 0.80	D3/D4	4.134 - 4.334	3	0.194	0.152	2.382	0.945	5.000	9039480050000	●
M6 X 1.00	D4/D5	4.917 - 5.153	3	0.255	0.191	2.500	1.181	6.000	9039480060000	●
M8 X 1.25	D4/D5	6.647 - 6.912	3	0.318	0.238	2.721	1.377	8.000	9039480080000	●
M10 X 1.50	D4/D5	8.376 - 8.676	3	0.381	0.286	2.941	1.456	10.000	9039480100000	●
M12 X 1.75	D5/D6	10.106 - 10.441	3	0.367	0.275	3.382	N/A	12.000	9039480120000	●
M14 X 2.00	D5/D6	11.835 - 12.210	3	0.429	0.322	3.591	N/A	14.000	9039480140000	●
M16 X 2.00	D6/D7	13.835 - 14.210	4	0.480	0.360	3.811	N/A	16.000	9039480160000	●
M18 X 2.50	D6/D7	15.294 - 15.744	4	0.542	0.406	4.032	N/A	18.000	9039480180000	●
M20 X 2.50	D6/D7	17.294 - 17.744	4	0.652	0.489	4.469	N/A	20.000	9039480200000	●
M22 X 2.50	D6/D7	19.294 - 19.744	4	0.697	0.523	4.689	N/A	22.000	9039480220000	●
M24 X 3.00	D7/D8	20.752 - 21.252	4	0.760	0.570	4.910	N/A	24.000	9039480240000	●
M30 X 3.50	D8/D9	26.211 - 26.771	4	1.021	0.766	5.433	N/A	30.000	9039480300000	●

METRIC FINE

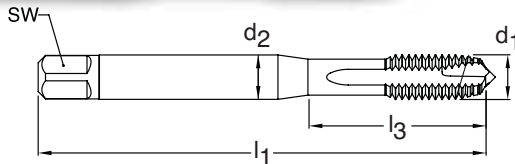

Series 3973
Standard ANSI
Tool Material HSS-E (Cobalt)
Spiral Point Straight flute
Chamfer Form B • 3.5 - 5
Class of Fit ISO 2(6H)

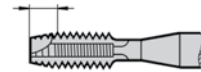

Through holes

TiN coated

External cooling

d1 - P	D Limits	Tap Drill Range mm	Number of Flutes	d2 inch	SW inch	l1 inch	l3 inch	Order Code	EDP Number	Stock
M6 X 0.75	D4/D5	5.188 - 5.378	3	0.255	0.191	2.500	1.181	6.004	9039730060040	●
M8 X 1.00	D4/D5	6.917 - 7.153	3	0.318	0.238	2.721	1.377	8.005	9039730080050	●
M10 X 1.00	D4/D5	8.917 - 9.153	3	0.381	0.286	2.941	1.378	10.005	9039730100050	●
M10 X 1.25	D4/D5	8.647 - 8.912	3	0.381	0.286	2.941	1.535	10.006	9039730100060	●
M12 X 1.00	D4/D5	10.917 - 11.153	4	0.367	0.275	3.382	N/A	12.005	9039730120050	●
M12 X 1.25	D4/D5	10.647 - 10.912	4	0.367	0.275	3.382	N/A	12.006	9039730120060	●
M12 X 1.50	D4/D5	10.376 - 10.676	4	0.367	0.275	3.382	N/A	12.007	9039730120070	●
M14 X 1.25	D4/D5	12.647 - 12.912	4	0.429	0.322	3.591	N/A	14.006	9039730140060	●
M14 X 1.50	D4/D5	12.376 - 12.676	4	0.429	0.322	3.591	N/A	14.007	9039730140070	●
M16 X 1.50	D4/D5	14.376 - 14.676	4	0.480	0.360	3.811	N/A	16.007	9039730160070	●
M18 X 1.50	D4/D5	16.376 - 16.676	4	0.542	0.406	4.032	N/A	18.007	9039730180070	●
M20 X 1.50	D6/D7	18.376 - 18.676	4	0.652	0.489	4.469	N/A	20.007	9039730200070	●
M22 X 1.50	D6/D7	20.376 - 20.676	4	0.697	0.523	4.689	N/A	22.007	9039730220070	●
M24 X 1.50	D6/D7	22.376 - 23.676	4	0.760	0.570	4.910	N/A	24.007	9039730240070	●

METRIC FINE

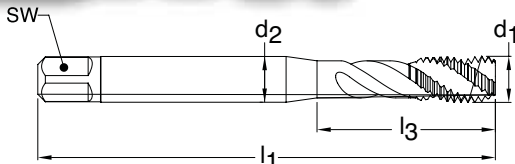

Series 3974
Standard ANSI
Tool Material HSS-E (Cobalt)
Spiral Flute 40° Helix
Chamfer Form C • 2-3
Class of Fit ISO 2(6H)



Blind holes

TiN coated

External cooling

d1 - P	D Limits	Tap Drill Range mm	Number of Flutes	d2 inch	SW inch	l1 inch	l3 inch	Order Code	EDP Number	Stock
M6 X 0.75	D3/D4	5.188 - 5.378	3	0.255	0.191	2.500	1.181	6.004	9039740060040	●
M8 X 1.00	D4/D5	6.917 - 7.153	3	0.318	0.238	2.721	1.377	8.005	9039740080050	●
M10 X 1.00	D4/D5	8.917 - 9.153	3	0.381	0.286	2.941	1.377	10.005	9039740100050	●
M10 X 1.25	D4/D5	8.647 - 8.912	3	0.381	0.286	2.941	1.535	10.006	9039740100060	●
M12 X 1.00	D4/D5	10.917 - 11.153	3	0.367	0.275	3.382	N/A	12.005	9039740120050	●
M12 X 1.25	D4/D5	10.647 - 10.912	3	0.367	0.275	3.382	N/A	12.006	9039740120060	●
M12 X 1.50	D5/D6	10.376 - 10.676	3	0.367	0.275	3.382	N/A	12.007	9039740120070	●
M14 X 1.25	D4/D5	12.647 - 12.912	3	0.429	0.322	3.591	N/A	14.006	9039740140060	●
M14 X 1.50	D4/D5	12.376 - 12.676	3	0.429	0.322	3.591	N/A	14.007	9039740140070	●
M16 X 1.50	D4/D5	14.376 - 14.676	4	0.480	0.360	3.811	N/A	16.007	9039740160070	●
M18 X 1.50	D4/D5	16.376 - 16.676	4	0.542	0.406	4.032	N/A	18.007	9039740180070	●
M20 X 1.50	D6/D7	18.376 - 18.676	4	0.652	0.489	4.469	N/A	20.007	9039740200070	●
M22 X 1.50	D6/D7	20.376 - 20.676	4	0.697	0.523	4.689	N/A	22.007	9039740220070	●
M24 X 1.50	D6/D7	22.376 - 23.676	4	0.760	0.570	4.910	N/A	24.007	9039740240070	●

"Tap drill Range" given is per the Class of Fit shown per Series #
 Additional Tap Drill sizes & percent of thread engagement can be found on pages 229-237.

METRIC

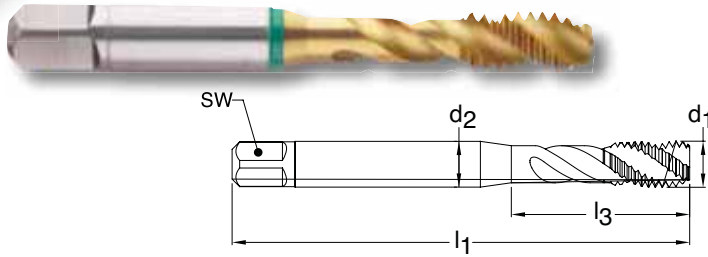

Series 3976
Standard ANSI
Tool Material HSS-E (Cobalt)
Spiral Flute 40° Helix
Chamfer Form E • 1.5-2
Class of Fit ISO 2(6H)

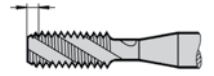

Blind holes



TiN coated



External cooling

d1 - P	D Limits	Tap Drill Range mm	Number of Flutes	d2 inch	SW inch	l1 inch	l3 inch	Order Code	EDP Number	Stock
M2 X 0.40	D2/D3	1.567 - 1.679	3	0.141	0.110	1.752	0.441	2.000	9039760020000	●
M3 X 0.50	D2/D3	2.459 - 2.599	3	0.141	0.110	1.941	0.709	3.000	9039760030000	●
M4 X 0.70	D3/D4	3.242 - 3.422	3	0.168	0.131	2.130	0.827	4.000	9039760040000	●
M5 X 0.80	D3/D4	4.134 - 4.334	3	0.194	0.152	2.382	0.945	5.000	9039760050000	●
M6 X 1.00	D4/D5	4.917 - 5.153	3	0.255	0.191	2.500	1.181	6.000	9039760060000	●
M8 X 1.25	D4/D5	6.647 - 6.912	3	0.318	0.238	2.721	1.377	8.000	9039760080000	●
M10 X 1.50	D4/D5	8.376 - 8.676	3	0.381	0.286	2.941	1.456	10.000	9039760100000	●
M12 X 1.75	D5/D6	10.106 - 10.441	3	0.367	0.275	3.382	N/A	12.000	9039760120000	●
M14 X 2.00	D5/D6	11.835 - 12.210	3	0.429	0.322	3.591	N/A	14.000	9039760140000	●
M16 X 2.00	D6/D7	13.835 - 14.210	4	0.480	0.360	3.811	N/A	16.000	9039760160000	●
M18 X 2.50	D6/D7	15.294 - 15.744	4	0.542	0.406	4.032	N/A	18.000	9039760180000	●
M20 X 2.50	D6/D7	17.294 - 17.744	4	0.652	0.489	4.469	N/A	20.000	9039760200000	●

METRIC



Series 4126
Standard ANSI
Chamfer Form C • 2-3
Class of Fit ISO 2(6H)

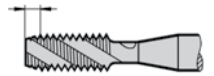

Blind holes



TiN coated



Axial coolant

d1 - P	D Limits	Tap Drill Range inch	Number of Flutes	d2 inch	SW inch	l1 inch	l3 inch	Order Code	EDP Number	Stock
M6 X 1.00	D4/D5	4.917 - 5.153	3	0.255	0.191	2.500	1.181	6.000	9041260060000	●
M8 X 1.25	D4/D5	6.647 - 6.912	3	0.318	0.238	2.720	1.377	8.000	9041260080000	●
M10 X 1.50	D4/D5	8.376 - 8.676	3	0.381	0.286	2.941	1.456	10.000	9041260100000	●
M12 X 1.75	D5/D6	10.106 - 10.441	3	0.367	0.275	3.381	N/A	12.000	9041260120000	●
M14 X 2.00	D5/D6	11.835 - 12.210	3	0.429	0.322	3.591	N/A	14.000	9041260140000	●
M16 X 2.00	D6/D7	13.835 - 14.210	3	0.480	0.360	3.811	N/A	16.000	9041260160000	●

METRIC

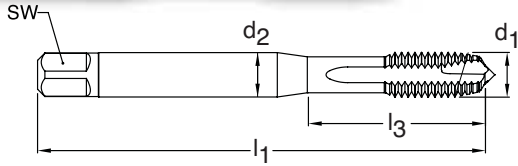

Series 2876
Standard DIN 371
Tool Material HSS-E (Cobalt)
Spiral Point Straight flute
Chamfer Form B • 3.5 - 5
Class of Fit ISO 2(6H)



Through holes **Steam oxide** **External cooling**

d1 - P	D Limits	Tap Drill Range mm	Number of Flutes	d2 mm	SW mm	l1 mm	l3 mm	Order Code	EDP Number	Stock
M3 X 0.50	D2/D3	2.459 - 2.599	3	3.50	2.70	56.00	18.00	3.000	9028760030000	○
M4 X 0.70	D3/D4	3.242 - 3.422	3	4.50	3.40	63.00	21.00	4.000	9028760040000	○
M5 X 0.80	D3/D4	4.134 - 4.334	3	6.00	4.90	70.00	25.00	5.000	9028760050000	○
M6 X 1.00	D4/D5	4.917 - 5.153	3	6.00	4.90	80.00	30.00	6.000	9028760060000	○
M8 X 1.25	D4/D5	6.647 - 6.912	3	8.00	6.20	90.00	35.00	8.000	9028760080000	●
M10 X 1.50	D4/D5	8.376 - 8.676	3	10.00	8.00	100.00	39.00	10.000	9028760100000	●

METRIC FINE

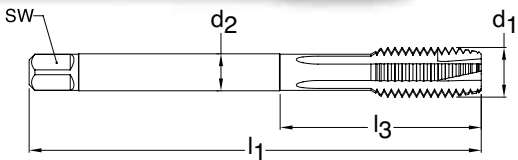

Series 2879
Standard DIN 374
Tool Material HSS-E (Cobalt)
Spiral Point Straight flute
Chamfer Form B • 3.5 - 5
Class of Fit ISO 2(6H)

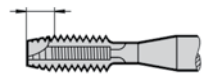

Through holes **Steam oxide** **External cooling**

d1 - P	D Limits	Tap Drill Range mm	Number of Flutes	d2 mm	SW mm	l1 mm	l3 mm	Order Code	EDP Number	Stock
M5 X 0.50	D3/D4	4.459 - 4.599	3	3.50	2.70	70.00	N/A	5.003	9028790050030	○
M8 X 0.75	D3/D4	7.188 - 7.378	3	6.00	4.90	80.00	N/A	8.004	9028790080040	○
M8 X 1.00	D4/D5	6.917 - 7.153	3	6.00	4.90	90.00	N/A	8.005	9028790080050	●
M10 X 1.00	D4/D5	8.917 - 9.153	3	7.00	5.50	90.00	N/A	10.005	9028790100050	○
M12 X 1.00	D4/D5	10.917 - 11.153	4	9.00	7.00	100.00	N/A	12.005	9028790120050	○
M14 X 1.50	D4/D5	12.376 - 12.676	4	11.00	9.00	100.00	N/A	14.007	9028790140070	○
M16 X 1.50	D4/D5	14.376 - 14.676	4	12.00	9.00	100.00	N/A	16.007	9028790160070	○
M18 X 1.50	D4/D5	16.376 - 16.676	4	14.00	11.00	110.00	N/A	18.007	9028790180070	○
M20 X 1.50	D6/D7	18.376 - 18.676	4	16.00	12.00	125.00	N/A	20.007	9028790200070	○

"Tap drill Range" given is per the Class of Fit shown per Series #
 Additional Tap Drill sizes & percent of thread engagement can be found on pages 229-237.

METRIC

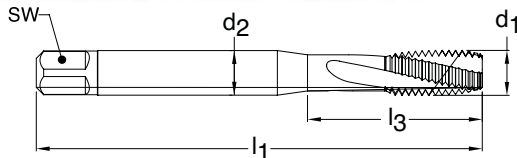

Series 4154
Standard DIN 371/376
Tool Material HSS-E (Cobalt)
Spiral Flute 15° Helix
Chamfer Form C • 2-3
Class of Fit ISO 2(6H)

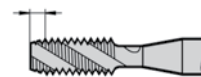

Blind holes **TiCN coated** **External cooling**

d1 - P	D Limits	Tap Drill Range mm	Number of Flutes	d2 mm	SW mm	l1 mm	l3 mm	Order Code	EDP Number	Stock
M3 X 0.50	D2/D3	2.459 - 2.599	3	3.50	2.70	56.00	18.00	3.000	9041540030000	○
M4 X 0.70	D3/D4	3.242 - 3.422	3	4.50	3.40	63.00	21.00	4.000	9041540040000	○
M5 X 0.80	D3/D4	4.134 - 4.334	3	6.00	4.90	70.00	25.00	5.000	9041540050000	○
M6 X 1.00	D4/D5	4.917 - 5.153	3	6.00	4.90	80.00	30.00	6.000	9041540060000	●
M8 X 1.25	D4/D5	6.647 - 6.912	3	8.00	6.20	90.00	35.00	8.000	9041540080000	●
M10 X 1.50	D4/D5	8.376 - 8.676	3	10.00	8.00	100.00	39.00	10.000	9041540100000	●
M12 X 1.75	D5/D6	10.106 - 10.441	3	9.00	7.00	110.00	N/A	12.000	9041540120000	○
M16 X 2.00	D6/D7	13.835 - 14.210	4	12.00	9.00	110.00	N/A	16.000	9041540160000	○
M20 X 2.50	D6/D7	17.294 - 17.744	4	16.00	12.00	140.00	N/A	20.000	9041540200000	○

METRIC FINE

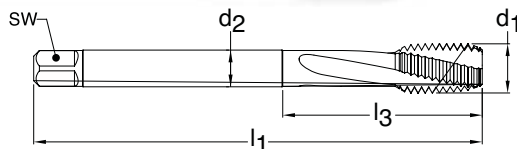

Series 4156
Standard DIN 374
Tool Material HSS-E (Cobalt)
Spiral Flute 15° Helix
Chamfer Form C • 2-3
Class of Fit ISO 2(6H)



Blind holes **TiCN coated** **External cooling**

d1 - P	D Limits	Tap Drill Range mm	Number of Flutes	d2 mm	SW mm	l1 mm	l3 mm	Order Code	EDP Number	Stock
M8 X 1.00	D4/D5	6.917 - 7.153	3	6.00	4.90	90.00	N/A	8.005	9041560080050	○
M10 X 1.00	D4/D5	8.917 - 9.153	3	7.00	5.50	90.00	N/A	10.005	9041560100050	○
M10 X 1.25	D4/D5	8.647 - 8.912	3	7.00	5.50	100.00	N/A	10.006	9041560100060	○
M12 X 1.00	D4/D5	10.917 - 11.153	3	9.00	7.00	100.00	N/A	12.005	9041560120050	○
M12 X 1.50	D4/D5	10.376 - 10.676	3	9.00	7.00	100.00	N/A	12.007	9041560120070	○
M14 X 1.50	D4/D5	12.376 - 12.676	3	11.00	9.00	100.00	N/A	14.007	9041560140070	○
M16 X 1.50	D4/D5	14.376 - 14.676	4	12.00	9.00	100.00	N/A	16.007	9041560160070	○

METRIC

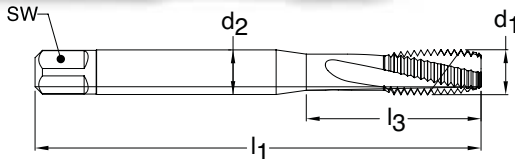

Series 4155
Standard DIN 371/376
Tool Material HSS-E (Cobalt)
Spiral Flute 15° Helix
Chamfer Form E • 1.5-2
Class of Fit ISO 2(6H)

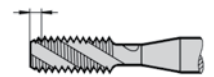

Blind holes
 TiCN coated
 External cooling

d1 - P	D Limits	Tap Drill Range mm	Number of Flutes	d2 mm	SW mm	l1 mm	l3 mm	Order Code	EDP Number	Stock
M3 X 0.50	D2/D3	2.459 - 2.599	3	3.50	2.70	56.00	18.00	3.000	9041550030000	○
M4 X 0.70	D3/D4	3.242 - 3.422	3	4.50	3.40	63.00	21.00	4.000	9041550040000	○
M5 X 0.80	D3/D4	4.134 - 4.334	3	6.00	4.90	70.00	25.00	5.000	9041550050000	○
M6 X 1.00	D4/D5	4.917 - 5.153	3	6.00	4.90	80.00	30.00	6.000	9041550060000	●
M8 X 1.25	D4/D5	6.647 - 6.912	3	8.00	6.20	90.00	35.00	8.000	9041550080000	●
M10 X 1.50	D4/D5	8.376 - 8.676	3	10.00	8.00	100.00	39.00	10.000	9041550100000	●
M12 X 1.75	D5/D6	10.106 - 10.441	3	9.00	7.00	110.00	N/A	12.000	9041550120000	○
M16 X 2.00	D6/D7	13.835 - 14.210	4	12.00	9.00	110.00	N/A	16.000	9041550160000	○
M20 X 2.50	D6/D7	17.294 - 17.744	4	16.00	12.00	140.00	N/A	20.000	9041550200000	○

METRIC FINE

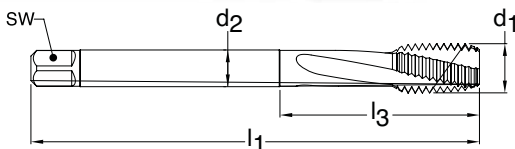

Series 4157
Standard DIN 374
Tool Material HSS-E (Cobalt)
Spiral Flute 15° Helix
Chamfer Form E • 1.5-2
Class of Fit ISO 2(6H)

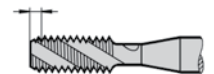

Blind holes
 TiCN coated
 External cooling

d1 - P	D Limits	Tap Drill Range mm	Number of Flutes	d2 mm	SW mm	l1 mm	l3 mm	Order Code	EDP Number	Stock
M8 X 1.00	D4/D5	6.917 - 7.153	3	6.00	4.90	90.00	N/A	8.005	9041570080050	○
M10 X 1.00	D4/D5	8.917 - 9.153	3	7.00	5.50	90.00	N/A	10.005	9041570100050	○
M10 X 1.25	D4/D5	8.647 - 8.912	3	7.00	5.50	100.00	N/A	10.006	9041570100060	○
M12 X 1.00	D4/D5	10.917 - 11.153	3	9.00	7.00	100.00	N/A	12.005	9041570120050	○
M12 X 1.50	D4/D5	10.376 - 10.676	3	9.00	7.00	100.00	N/A	12.007	9041570120070	○
M14 X 1.50	D4/D5	12.376 - 12.676	3	11.00	9.00	100.00	N/A	14.007	9041570140070	○
M16 X 1.50	D4/D5	14.376 - 14.676	4	12.00	9.00	100.00	N/A	16.007	9041570160070	○

"Tap drill Range" given is per the Class of Fit shown per Series #
 Additional Tap Drill sizes & percent of thread engagement can be found on pages 229-237.

METRIC

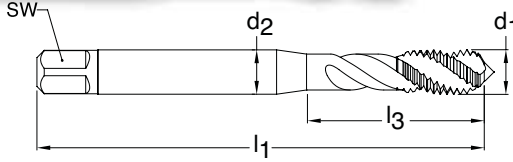

Blind holes



Bright finish



External cooling

Series 889
Standard DIN 371
Tool Material HSS-E (Cobalt)
Spiral Flute 40° Helix
Chamfer Form C • 2-3
Class of Fit ISO 2(6H)



d1 - P	D Limits	Tap Drill Range mm	Number of Flutes	d2 mm	SW mm	l1 mm	l3 mm	Order Code	EDP Number	Stock
M2 X 0.40	D2/D3	1.567 - 1.679	3	2.80	2.10	45.00	12.50	2.000	9008890020000	○
M2.2 X 0.45	D2/D3	1.713 - 1.838	3	2.80	2.10	45.00	13.50	2.200	9008890022000	●
M2.5 X 0.45	D2/D3	2.013 - 2.138	3	2.80	2.10	50.00	13.50	2.500	9008890025000	○
M2.6 X 0.45	D2/D3	2.110 - 2.240	3	2.80	2.10	50.00	13.50	2.600	9008890026000	○
M3 X 0.50	D3/D4	2.459 - 2.599	3	3.50	2.70	56.00	18.00	3.000	9008890030000	○
M3.5 X 0.60	D3/D4	2.850 - 3.010	3	4.00	3.00	56.00	20.00	3.500	9008890035000	○
M4 X 0.70	D3/D4	3.242 - 3.422	3	4.50	3.40	63.00	21.00	4.000	9008890040000	○
M5 X 0.80	D4/D5	4.134 - 4.334	3	6.00	4.90	70.00	25.00	5.000	9008890050000	○
M6 X 1.00	D4/D5	4.917 - 5.153	3	6.00	4.90	80.00	30.00	6.000	9008890060000	●
M8 X 1.25	D4/D5	6.647 - 6.912	3	8.00	6.20	90.00	35.00	8.000	9008890080000	●
M10 X 1.50	D4/D5	8.376 - 8.676	3	10.00	8.00	100.00	39.00	10.000	9008890100000	○

METRIC



Blind holes



Bright finish



External cooling

Chamfer Form E • 1.5-2

Series 2790
Standard DIN 371
Tool Material HSS-E PM
Spiral Flute 40° Helix
Class of Fit ISO 2(6H)

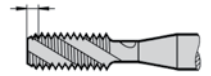

d1 - P	D Limits	Tap Drill Range mm	Number of Flutes	d2 mm	SW mm	l1 mm	l3 mm	Order Code	EDP Number	Stock
M3 X 0.50	D2/D3	2.459 - 2.599	3	3.50	2.70	56.00	18.00	3.000	9027900030000	●
M4 X 0.70	D3/D4	3.242 - 3.422	3	4.50	3.40	63.00	21.00	4.000	9027900040000	●
M5 X 0.80	D3/D4	4.134 - 4.334	3	6.00	4.90	70.00	25.00	5.000	9027900050000	●
M6 X 1.00	D4/D5	4.917 - 5.153	3	6.00	4.90	80.00	30.00	6.000	9027900060000	●
M8 X 1.25	D4/D5	6.647 - 6.912	3	8.00	6.20	90.00	35.00	8.000	9027900080000	●
M10 X 1.50	D4/D5	8.376 - 8.676	3	10.00	8.00	100.00	39.00	10.000	9027900100000	●

METRIC



Blind holes



TICN coated



Axial coolant

Series 1152
Standard DIN 371
Tool Material HSS-E PM
Spiral Flute 50° Helix
Chamfer Form C • 2-3
Class of Fit ISO 2(6H)

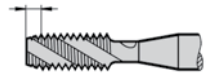

d1 - P	D Limits	Tap Drill Range mm	Number of Flutes	d2 mm	SW mm	l1 mm	l3 mm	Order Code	EDP Number	Stock
M5 X 0.80	D3/D4	4.134 - 4.334	3	6.00	4.90	70.00	25.00	5.000	9011520050000	○
M6 X 1.00	D4/D5	4.917 - 5.153	3	6.00	4.90	80.00	30.00	6.000	9011520060000	○
M8 X 1.25	D4/D5	6.647 - 6.912	3	8.00	6.20	90.00	35.00	8.000	9011520080000	○
M10 X 1.50	D4/D5	8.376 - 8.676	3	10.00	8.00	100.00	39.00	10.000	9011520100000	○

METRIC

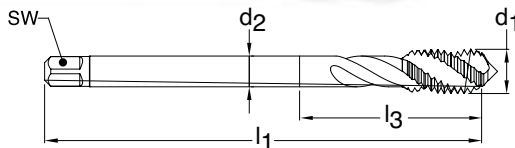

Series 890
Standard DIN 376
Tool Material HSS-E (Cobalt)
Spiral Flute 40° Helix
Chamfer Form C • 2-3
Class of Fit ISO 2(6H)

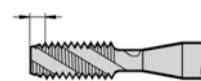

Blind holes **Bright finish** **External cooling**

d1 - P	D Limits	Tap Drill Range mm	Number of Flutes	d2 mm	SW mm	l1 mm	l3 mm	Order Code	EDP Number	Stock
M3 X 0.50	D2/D3	2.459 - 2.599	3	2.20	N/A	56.00	N/A	3.000	9008900030000	○
M4 X 0.70	D3/D4	3.242 - 3.422	3	2.80	2.10	63.00	N/A	4.000	9008900040000	○
M5 X 0.80	D3/D4	4.134 - 4.334	3	3.50	2.70	70.00	N/A	5.000	9008900050000	○
M6 X 1.00	D4/D5	4.917 - 5.153	3	4.50	3.40	80.00	N/A	6.000	9008900060000	○
M8 X 1.25	D4/D5	6.647 - 6.912	3	6.00	4.90	90.00	N/A	8.000	9008900080000	○
M10 X 1.50	D4/D5	8.376 - 8.676	3	7.00	5.50	100.00	N/A	10.000	9008900100000	●
M12 X 1.75	D5/D6	10.106 - 10.441	3	9.00	7.00	110.00	N/A	12.000	9008900120000	○
M14 X 2.00	D5/D6	11.835 - 12.210	3	11.00	9.00	110.00	N/A	14.000	9008900140000	○
M16 X 2.00	D6/D7	13.835 - 14.210	4	12.00	9.00	110.00	N/A	16.000	9008900160000	●
M20 X 2.50	D6/D7	17.294 - 17.744	4	16.00	12.00	140.00	N/A	20.000	9008900200000	●
M24 X 3.00	D7/D8	20.752 - 21.252	4	18.00	14.50	160.00	N/A	24.000	9008900240000	●

METRIC



Series 2791
Standard DIN 376
Tool Material HSS-E (Cobalt)
Spiral Flute 40° Helix

Chamfer Form E • 1.5-2

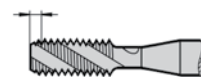

Class of Fit ISO 2(6H)
External cooling

Blind holes **Bright finish**

d1 - P	D Limits	Tap Drill Range mm	Number of Flutes	d2 mm	SW mm	l1 mm	l3 mm	Order Code	EDP Number	Stock
M6 X 1.00	D4/D5	4.917 - 5.153	3	4.50	3.40	80.00	N/A	6.000	9027910060000	●
M8 X 1.25	D4/D5	6.647 - 6.912	3	6.00	4.90	90.00	N/A	8.000	9027910080000	○
M10 X 1.50	D4/D5	8.376 - 8.676	3	7.00	5.50	100.00	N/A	10.000	9027910100000	●
M12 X 1.75	D5/D6	10.106 - 10.441	3	9.00	7.00	110.00	N/A	12.000	9027910120000	●
M14 X 2.00	D5/D6	11.835 - 12.210	3	11.00	9.00	110.00	N/A	14.000	9027910140000	●
M16 X 2.00	D6/D7	13.835 - 14.210	4	12.00	9.00	110.00	N/A	16.000	9027910160000	○

METRIC



Series 1293
Standard DIN 376
Tool Material HSS-E PM
Spiral Flute 50° Helix

Chamfer Form C • 1.5-2

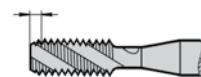

Class of Fit ISO 2(6H)
Axial coolant

Blind holes **TiCN coated**

d1 - P	D Limits	Tap Drill Range mm	Number of Flutes	d2 mm	SW mm	l1 mm	l3 mm	Order Code	EDP Number	Stock
M12 X 1.75	D5/D6	10.106 - 10.441	3	9.00	7.00	110.00	N/A	12.000	9012930120000	○
M14 X 2.00	D5/D6	11.835 - 12.210	3	11.00	9.00	110.00	N/A	14.000	9012930140000	○
M16 X 2.00	D6/D7	13.835 - 14.210	4	12.00	9.00	110.00	N/A	16.000	9012930160000	○
M20 X 2.50	D6/D7	17.294 - 17.744	4	16.00	12.00	140.00	N/A	20.000	9012930200000	○

"Tap drill Range" given is per the Class of Fit shown per Series #
 Additional Tap Drill sizes & percent of thread engagement can be found on pages 229-237.

METRIC FINE

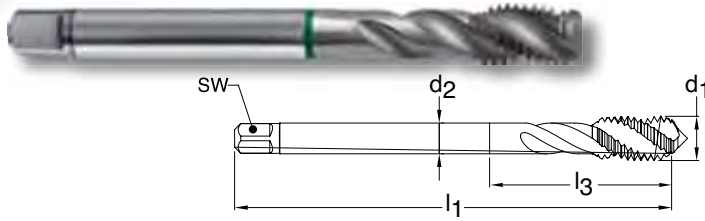

Series 2424
Standard DIN 374
Tool Material HSS-E (Cobalt)
Spiral Flute 40° Helix
Chamfer Form C • 2-3
Class of Fit ISO 2(6H)



Blind holes **Bright finish** **External cooling**

d1 - P	D Limits	Tap Drill Range mm	Number of Flutes	d2 mm	SW mm	l1 mm	l3 mm	Order Code	EDP Number	Stock
M5 X 0.50	D3/D4	4.459 - 4.599	3	3.50	2.70	70.00	N/A	5.003	9024240050030	○
M6 X 0.75	D3/D4	5.188 - 5.378	3	4.50	3.40	80.00	N/A	6.004	9024240060040	●
M8 X 1.00	D4/D5	6.917 - 7.153	3	6.00	4.90	90.00	N/A	8.005	9024240080050	○
M10 X 1.00	D4/D5	8.917 - 9.153	3	7.00	5.50	90.00	N/A	10.005	9024240100050	●
M10 X 1.25	D4/D5	8.647 - 8.912	3	7.00	5.50	100.00	N/A	10.006	9024240100060	○
M12 X 1.00	D4/D5	10.917 - 11.153	3	9.00	7.00	100.00	N/A	12.005	9024240120050	●
M12 X 1.25	D4/D5	10.647 - 10.912	3	9.00	7.00	100.00	N/A	12.006	9024240120060	○
M12 X 1.50	D4/D5	10.376 - 10.676	3	9.00	7.00	100.00	N/A	12.007	9024240120070	○
M14 X 1.00	D4/D5	12.917 - 13.153	3	11.00	9.00	100.00	N/A	14.005	9024240140050	○
M14 X 1.50	D4/D5	12.376 - 12.676	3	11.00	9.00	100.00	N/A	14.007	9024240140070	○
M16 X 1.50	D4/D5	14.376 - 14.676	4	12.00	9.00	100.00	N/A	16.007	9024240160070	○
M18 X 1.50	D4/D5	16.376 - 16.676	4	14.00	11.00	110.00	N/A	18.007	9024240180070	●
M20 X 1.50	D6/D7	18.376 - 18.676	4	16.00	12.00	125.00	N/A	20.007	9024240200070	●
M24 X 1.50	D6/D7	22.376 - 22.676	4	18.00	14.50	140.00	N/A	24.007	9024240240070	○
M24 X 2.00	D6/D7	21.835 - 22.210	4	18.00	14.50	140.00	N/A	24.008	9024240240080	●

METRIC FINE



Series 2792
Standard DIN 374
Tool Material HSS-E (Cobalt)
Spiral Flute 40° Helix
Chamfer Form E • 1.5-2
Class of Fit ISO 2(6H)

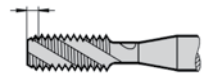

Blind holes **Bright finish** **External cooling**

d1 - P	D Limits	Tap Drill Range mm	Number of Flutes	d2 mm	SW mm	l1 mm	l3 mm	Order Code	EDP Number	Stock
M10 X 1.00	D4/D5	8.917 - 9.153	3	7.00	5.50	90.00	N/A	10.005	9027920100050	●
M12 X 1.00	D4/D5	10.917 - 11.153	3	9.00	7.00	100.00	N/A	12.005	9027920120050	●
M12 X 1.25	D4/D5	10.647 - 10.912	3	9.00	7.00	100.00	N/A	12.006	9027920120060	○
M12 X 1.50	D4/D5	10.376 - 10.676	3	9.00	7.00	100.00	N/A	12.007	9027920120070	●
M14 X 1.50	D4/D5	12.376 - 12.676	3	11.00	9.00	100.00	N/A	14.007	9027920140070	○

METRIC FINE



Series 1294
Standard DIN 374
Tool Material HSS-E PM
Spiral Flute 50° Helix
Chamfer Form C • 2-3
Class of Fit ISO 2(6H)

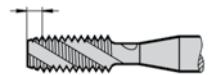

Blind holes **TICN coated** **Axial coolant**

d1 - P	D Limits	Tap Drill Range mm	Number of Flutes	d2 mm	SW mm	l1 mm	l3 mm	Order Code	EDP Number	Stock
M8 X 1.00	D4/D5	6.917 - 7.153	3	6.00	4.90	90.00	N/A	8.005	9012940080050	○
M10 X 1.00	D4/D5	8.917 - 9.153	3	7.00	5.50	90.00	N/A	10.005	9012940100050	○
M12 X 1.00	D4/D5	10.917 - 11.153	3	9.00	7.00	100.00	N/A	12.005	9012940120050	○
M12 X 1.50	D4/D5	10.376 - 10.676	3	9.00	7.00	100.00	N/A	12.007	9012940120070	○
M14 X 1.50	D4/D5	12.376 - 12.676	3	11.00	9.00	100.00	N/A	14.007	9012940140070	○
M16 X 1.50	D4/D5	14.376 - 14.676	4	12.00	9.00	100.00	N/A	16.007	9012940160070	○
M18 X 1.50	D4/D5	16.376 - 16.676	4	14.00	11.00	110.00	N/A	18.007	9012940180070	○
M20 X 1.50	D6/D7	18.376 - 18.676	4	16.00	12.00	125.00	N/A	20.007	9012940200070	○

Metric - Oversized + 0.003"

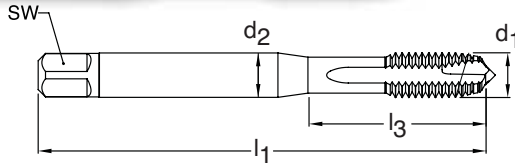

Series 4331
Standard DIN 371/376
Tool Material HSS-E (Cobalt)
Spiral Point Straight flute
Chamfer Form B • 3.5 - 5
Class of Fit 6H + 0.003"



Through holes



TiN coated



External cooling

d1 - P	D Limits	Tap Drill Range mm	Number of Flutes	d2 mm	SW mm	l1 mm	l3 mm	Order Code	EDP Number	Stock
M5 x 0.80	D10	4.210 - 4.410	3	6.00	4.90	70.00	25.00	5.000	9043310050000	●
M6 x 1.00	D11	4.993 - 5.229	3	6.00	4.90	80.00	30.00	6.000	9043310060000	●
M8 x 1.25	D11	6.723 - 6.988	3	8.00	6.20	90.00	35.00	8.000	9043310080000	●
M10 x 1.50	D12	8.452 - 8.752	3	10.00	8.00	100.00	39.00	10.000	9043310100000	●
M12 x 1.75	D12	10.182 - 10.517	4	9.00	7.00	110.00	N/A	12.000	9043310120000	●
M16 x 2.00	D13	13.911 - 14.286	4	12.00	9.00	110.00	N/A	16.000	9043310160000	●
M20 x 2.50	D13	17.370 - 17.820	4	16.00	12.00	140.00	N/A	20.000	9043310200000	●

Metric - Oversized + 0.003"

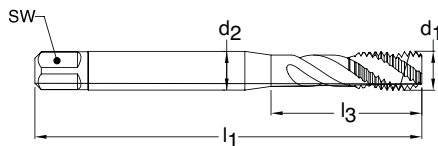

Series 4311
Standard DIN 371/376
Tool Material HSS-E (Cobalt)
Spiral Point Straight flute
Chamfer Form C • 2-3
Class of Fit 6H + 0.003"



Blind holes



TiN coated



External cooling

d1 - P	D Limits	Tap Drill Range mm	Number of Flutes	d2 mm	SW mm	l1 mm	l3 mm	Order Code	EDP Number	Stock
M5 x 0.80	D10	4.210 - 4.410	3	6.00	4.90	70.00	25.00	5.000	9043110050000	●
M6 x 1.00	D11	4.993 - 5.229	3	6.00	4.90	80.00	30.00	6.000	9043110060000	●
M8 x 1.25	D11	6.723 - 6.988	3	8.00	6.20	90.00	35.00	8.000	9043110080000	●
M10 x 1.50	D12	8.452 - 8.752	3	10.00	8.00	100.00	39.00	10.000	9043110100000	●
M12 x 1.75	D12	10.182 - 10.517	3	9.00	7.00	110.00	N/A	12.000	9043110120000	●
M16 x 2.00	D13	13.911 - 14.286	4	12.00	9.00	110.00	N/A	16.000	9043110160000	●
M20 x 2.50	D13	17.370 - 17.820	4	16.00	12.00	140.00	N/A	20.000	9043110200000	●

TECH TIP: Oversized pitch Ø taps

Due to varied machining capabilities and manufacturing processes there are times that a customer will be looking for a tap with what is considered to be an oversize pitch diameter. Most of these cases involve either some form of plating or over-coating being applied to the manufactured part or a heat treatment process that would cause some material shrinkage. Guhring now offers you a Standard Fractional offering option of +0.003" or +0.005" and a Metric offering with +0.003".

METRIC — EG-M

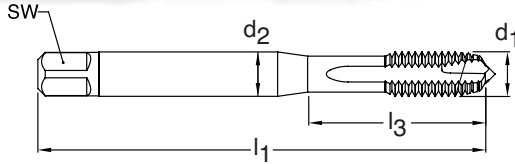

Series 1010
Standard DIN 40435
Tool Material HSS-E (Cobalt)
Spiral Point Straight flute
Chamfer Form B • 3.5 - 5
Class of Fit 6H mod

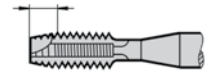

Through holes **TiN coated** **External cooling**

d1 - P	D Limits	Tap Drill Range mm	Number of Flutes	d2 mm	SW mm	l1 mm	l3 mm	Order Code	EDP Number	Stock
M4 X 0.70	D3/D4	4.152 - 4.292	3	6.00	4.90	70.00	25.00	4.000	9010100040000	○
M5 X 0.80	D3/D4	5.174 - 5.334	3	6.00	4.90	80.00	30.00	5.000	9010100050000	○
M6 X 1.00	D4/D5	6.217 - 6.407	3	8.00	6.20	90.00	35.00	6.000	9010100060000	●
M8 X 1.25	D4/D5	8.271 - 8.483	3	10.00	8.00	100.00	39.00	8.000	9010100080000	●
M10 X 1.50	D4/D5	10.324 - 10.560	3	9.00	7.00	110.00	N/A	10.000	9010100100000	●
M12 X 1.75	D5/D6	12.379 - 12.644	4	11.00	9.00	110.00	N/A	12.000	9010100120000	○
M14 X 2.00	D5/D6	14.271 - 14.483	4	12.00	9.00	110.00	N/A	14.000	9010100140000	○
M16 X 2.00	D6/D7	16.433 - 16.733	4	14.00	11.00	125.00	N/A	16.000	9010100160000	○

METRIC — EG-M

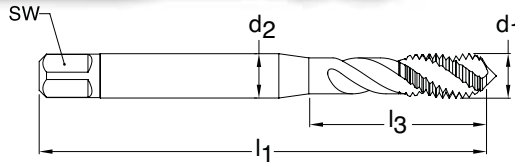

Series 1011
Standard DIN 40435
Tool Material HSS-E (Cobalt)
Spiral Flute 40° Helix
Chamfer Form C • 2-3
Class of Fit 6H mod



Blind holes **TiN coated** **External cooling**

d1 - P	D Limits	Tap Drill Range mm	Number of Flutes	d2 mm	SW mm	l1 mm	l3 mm	Order Code	EDP Number	Stock
M4 X 0.70	D3/D4	4.152 - 4.292	3	6.00	4.90	70.00	25.00	4.000	9010110040000	○
M5 X 0.08	D3/D4	5.174 - 5.334	3	6.00	4.90	80.00	30.00	5.000	9010110050000	○
M6 X 1.00	D4/D5	6.217 - 6.407	3	8.00	6.20	90.00	35.00	6.000	9010110060000	○
M8 X 1.25	D4/D5	8.271 - 8.483	3	10.00	8.00	100.00	39.00	8.000	9010110080000	●
M10 X 1.50	D4/D5	10.324 - 10.560	3	9.00	7.00	110.00	N/A	10.000	9010110100000	●
M12 X 1.75	D5/D6	12.379 - 12.644	3	11.00	9.00	110.00	N/A	12.000	9010110120000	○
M14 X 2.00	D5/D6	14.271 - 14.483	4	12.00	9.00	110.00	N/A	14.000	9010110140000	○
M16 X 2.00	D6/D7	16.433 - 16.733	4	14.00	11.00	125.00	N/A	16.000	9010110160000	○

TECH TIP: Heli-Coil or STI Taps – with EG designation (Metric and Metric Fine)

EG is the German equivalent of STI. Einsatz Gewinde translates to “Thread insert”

An EG (or STI) Tap is designed to create an oversized, threaded hole so it can accommodate the required Heli-Coil insert. Screw Thread Inserts are helically formed coils of diamond-shaped stainless steel or Phosphorous bronze wire that screw into a threaded hole to form a mating internal thread.

Screw Thread Inserts are a convenient way of repairing stripped out threads and are also used to provide stronger threads in soft materials than what can be obtained by directly tapping the base material. Aluminum, zinc die cast, magnesium and even wood are some materials that an STI may be used in.

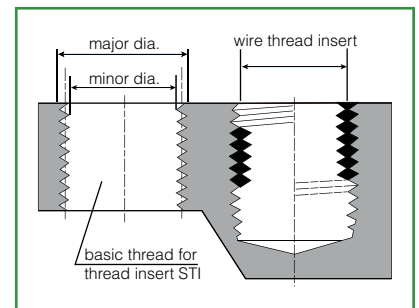

TAPS FOR THE ENERGY INDUSTRY

Oil and Gas, Wind Generators,
and other applications

Material group	Approximate Rc	Approximate HB	Recommended SFM			
			HSS-E		HSS-E-PM	
			bright finish	hard coated	bright finish	hard coated
Structural steels	<25	<250	--	25 - 50	--	35 - 60
Alloyed and heat-treatable steels	<30	<280	--	20 - 40	--	30 - 50
Stainless steels	<35	<320	--	15 - 30	--	25 - 45
	<38	<380	--	6 - 10	--	8 - 15

UNC HSS-E Taps for Alloyed & Stainless

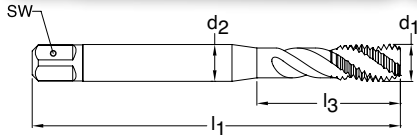

Series 4392
Standard DIN/ANSI
Tool Material HSS-E
Spiral Flute 40° Helix

Chamfer Form C • 2-3



Class of Fit 2BX



Blind holes



TiN coated



External cooling

d1 - P	D Limits	Tap Drill Range mm	Number of Flutes	d2 inch	SW inch	l1 inch	l3 inch	Order Code	EDP Number	Stock
2-56	H3/H4	0.067 - 0.074	3	0.141	0.110	1.969	0.441	2.184	9043920021840	●
4-40	H3/H4	0.085 - 0.094	3	0.141	0.110	2.205	0.709	2.845	9043920028450	●
5-40	H3/H4	0.098 - 0.106	3	0.141	0.110	2.205	0.709	3.175	9043920031750	●
6-32	H4/H5	0.104 - 0.114	3	0.141	0.110	2.205	0.709	3.505	9043920035050	●
8-32	H4/H5	0.130 - 0.139	3	0.168	0.131	2.480	0.827	4.166	9043920041660	●
10-24	H4/H5	0.145 - 0.155	3	0.194	0.152	2.756	0.945	4.826	9043920048260	●
12-24	H4/H5	0.171 - 0.181	3	0.220	0.165	3.150	1.024	5.486	9043920054860	●
1/4-20	H5/H6	0.196 - 0.207	3	0.255	0.191	3.150	1.181	6.350	9043920063500	●
5/16-18	H5/H6	0.252 - 0.265	3	0.318	0.238	3.543	1.377	7.938	9043920079380	●
3/8-16	H6/H7	0.307 - 0.321	3	0.381	0.286	3.937	1.456	9.525	9043920095250	●
7/16-14	H6/H7	0.360 - 0.376	3	0.323	0.242	3.937	N/A	11.113	9043920111130	●
1/2-13	H6/H7	0.417 - 0.434	3	0.367	0.275	4.331	N/A	12.700	9043920127000	●
9/16-12	H6/H7	0.472 - 0.490	3	0.429	0.322	4.331	N/A	14.288	9043920142880	●
5/8-11	H6/H7	0.527 - 0.546	4	0.480	0.360	4.331	N/A	15.875	9043920158750	●
3/4-10	H6/H7	0.642 - 0.663	4	0.590	0.442	4.921	N/A	19.050	9043920190500	●
7/8-9	H7/H8	0.755 - 0.778	4	0.697	0.523	5.512	N/A	22.225	9043920222250	●

UNF HSS-E Taps for Alloyed & Stainless

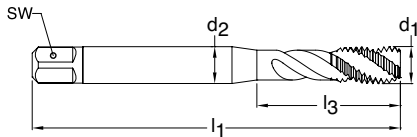

Series 4393
Standard DIN/ANSI
Tool Material HSS-E
Spiral Flute 40° Helix

Chamfer Form C • 2-3



Class of Fit 2BX



Blind holes



TiN coated



External cooling

d1 - P	D Limits	Tap Drill Range mm	Number of Flutes	d2 inch	SW inch	l1 inch	l3 inch	Order Code	EDP Number	Stock
2-64	H3/H4	0.069 - 0.075	3	0.141	0.110	1.969	0.441	2.184	9043930021840	●
4-48	H3/H4	0.089 - 0.097	3	0.141	0.110	2.205	0.709	2.845	9043930028450	●
5-44	H3/H4	0.100 - 0.108	3	0.141	0.110	2.205	0.709	3.175	9043930031750	●
6-40	H3/H4	0.111 - 0.119	3	0.141	0.110	2.205	0.709	3.505	9043930035050	●
8-36	H3/H4	0.134 - 0.142	3	0.168	0.131	2.480	0.827	4.166	9043930041660	●
10-32	H4/H5	0.156 - 0.164	3	0.194	0.152	2.756	0.945	4.826	9043930048260	●
12-28	H4/H5	0.177 - 0.186	3	0.220	0.165	3.150	1.024	5.486	9043930054860	●
1/4-28	H4/H5	0.211 - 0.220	3	0.255	0.191	3.150	1.181	6.350	9043930063500	●
5/16-24	H4/H5	0.267 - 0.277	3	0.318	0.238	3.543	1.377	7.938	9043930079380	●
3/8-24	H4/H5	0.330 - 0.340	3	0.381	0.286	3.543	1.456	9.525	9043930095250	●
7/16-20	H5/H6	0.383 - 0.395	3	0.323	0.242	3.937	N/A	11.113	9043930111130	●
1/2-20	H5/H6	0.446 - 0.457	3	0.367	0.275	3.937	N/A	12.700	9043930127000	●
9/16-18	H5/H6	0.502 - 0.515	3	0.429	0.322	3.937	N/A	14.288	9043930142880	●
5/8-18	H5/H6	0.565 - 0.578	4	0.480	0.360	3.937	N/A	15.875	9043930158750	●
3/4-16	H6/H7	0.682 - 0.696	4	0.590	0.442	4.331	N/A	19.050	9043930190500	●
7/8-14	H7/H8	0.798 - 0.813	4	0.697	0.523	4.921	N/A	22.225	9043930222250	●
1-12	H7/H8	0.910 - 0.928	4	0.800	0.600	5.512	N/A	25.400	9043930254000	●

HSS-E 8-Pitch Taps

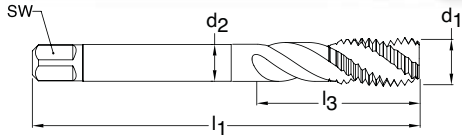

Series 4289
Standard DIN/ANSI
Tool Material HSS-E
Spiral Flute 40° Helix
Chamfer Form C • 2-3
Class of Fit 2B

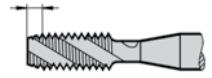

Blind holes **TiN coated** **External cooling**

d1 - P	D Limits	Tap Drill Range inch	Number of Flutes	d2 inch	SW inch	l1 inch	l3 inch	Order Code	EDP Number	Stock
1 - 8	H6	0.865 - 0.890	4	0.800	0.600	6.299	N/A	25.400	9042890254000	●
1 1/8 - 8	H7	0.990 - 1.015	4	0.896	0.672	7.087	N/A	28.575	9042890285750	●
1 1/4 - 8	H7	1.115 - 1.140	4	1.021	0.766	7.087	N/A	31.750	9042890317500	●
1 3/8 - 8	H7	1.240 - 1.265	4	1.108	0.831	7.874	N/A	34.925	9042890349250	●
1 1/2 - 8	H7	1.365 - 1.390	6	1.233	0.925	7.874	N/A	38.100	9042890381000	●
1 5/8 - 8	H7	1.490 - 1.515	6	1.305	0.979	7.874	N/A	41.275	9042890412750	●
1 3/4 - 8	H7	1.615 - 1.640	6	1.430	1.072	7.874	N/A	44.450	9042890444500	●
2 - 8	H7	1.865 - 1.890	6	1.644	1.233	8.858	N/A	50.800	9042890508000	●
2 1/4 - 8	H8	2.115 - 2.140	6	1.894	1.420	9.843	N/A	57.150	9042890571500	●

METRIC

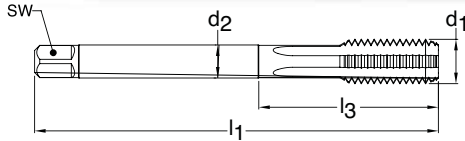

Series 778
Standard DIN 376
Tool Material HSS-E (Cobalt)
Flute Straight flute
Chamfer Form C • 2-3
Class of Fit 6HX



Blind holes **TiCN coated** **Axial coolant**

d1 - P	D Limits	Tap Drill Range mm	Number of Flutes	d2 mm	SW mm	l1 mm	l3 mm	Order Code	EDP Number	Stock
M16 X 2.00	D7/D8	13.835 - 14.210	4	12.00	9.00	110.00	N/A	16.000	9007780160000	●
M20 X 2.50	D7/D8	17.294 - 17.744	4	16.00	12.00	140.00	N/A	20.000	9007780200000	○
M24 X 3.00	D8/D9	20.752 - 21.252	5	18.00	14.50	160.00	N/A	24.000	9007780240000	●
M27 X 3.00	D8/D9	23.752 - 24.252	5	20.00	16.00	160.00	N/A	27.000	9007780270000	○
M30 X 3.50	D9/D10	26.211 - 26.771	5	22.00	18.00	180.00	N/A	30.000	9007780300000	●
M33 X 3.50	D9/D10	31.376 - 31.676	6	25.00	20.00	180.00	N/A	33.000	9007780330000	○
M36 X 4.00	D9/D10	31.670 - 32.270	6	28.00	22.00	200.00	N/A	36.000	9007780360000	○
M39 X 4.00	D10/D11	34.690 - 35.780	6	32.00	24.00	200.00	N/A	39.000	9007780390000	○

METRIC - EXTENDED LENGTH

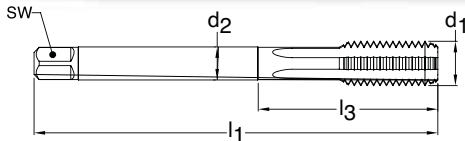

Series 779
Standard ~DIN 376
Tool Material HSS-E (Cobalt)
Flute Straight flute
Chamfer Form C • 2-3
Class of Fit 6HX



Blind holes **TiCN coated** **Axial coolant**

d1 - P	D Limits	Tap Drill Range mm	Number of Flutes	d2 mm	SW mm	l1 mm	l3 mm	Order Code	EDP Number	Stock
M16 X 2.00	D7/D8	13.835 - 14.210	3	12.00	9.00	160.00	N/A	16.000	9007790160000	○
M20 X 2.50	D7/D8	17.294 - 17.744	3	16.00	12.00	180.00	N/A	20.000	9007790200000	○
M24 X 3.00	D8/D9	20.752 - 21.252	4	18.00	14.50	200.00	N/A	24.000	9007790240000	○
M27 X 3.00	D8/D9	23.752 - 24.252	4	20.00	16.00	225.00	N/A	27.000	9007790270000	○
M30 X 3.50	D9/D10	26.211 - 26.711	4	22.00	18.00	250.00	N/A	30.000	9007790300000	○
M33 X 3.50	D9/D10	29.211 - 29.711	4	25.00	20.00	275.00	N/A	33.000	9007790330000	○
M36 X 4.00	D9/D10	31.670 - 32.270	5	28.00	22.00	300.00	N/A	36.000	9007790360000	○
M39 X 4.00	D11/D12	34.690 - 35.780	5	32.00	24.00	325.00	N/A	39.000	9007790390000	○

"Tap drill Range" given is per the Class of Fit shown per Series #
 Additional Tap Drill sizes & percent of thread engagement can be found on pages 229-237.



BLUE RING CUT TAPS

Stainless Steel
Aerospace Alloys

Material group	Approximate Rc	Approximate HB	Recommended SFM			
			HSS-E		HSS-E-PM	
			bright finish	hard coated	bright finish	hard coated
Stainless- and acid-resistant steels, sulphured austenitic martensitic		<180	25-35	40-55	30-55	35-70
	<25	<250	20-30	30-40	30-50	35-60
	<30	<280	20-30	25-40	25-45	30-50
	<35	<320	10-20	20-30	20-35	25-50

UNC

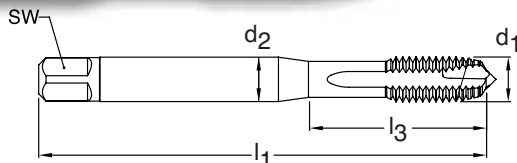

Series 3907
Standard ANSI
Tool Material HSS-E PM
Spiral Point Straight flute
Chamfer Form B • 3.5 - 5
Class of Fit 2B

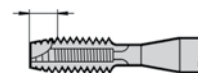

Through holes **TiN coated** **External cooling**

d1 - P	H Limits	Tap Drill Range inch	Number of Flutes	d2 inch	SW inch	l1 inch	l3 inch	Order Code	EDP Number	Stock
4-40	H2/H3	0.085 - 0.094	3	0.141	0.110	1.882	0.709	2.845	9039070028450	●
5-40	H2/H3	0.098 - 0.106	3	0.141	0.110	1.941	0.709	3.175	9039070031750	●
6-32	H3/H4	0.104 - 0.114	3	0.141	0.110	2.000	0.748	3.505	9039070035050	●
8-32	H3/H4	0.130 - 0.139	3	0.168	0.131	2.130	0.827	4.166	9039070041660	●
10-24	H3/H4	0.145 - 0.155	3	0.194	0.152	2.382	0.945	4.826	9039070048260	●
12-24	H3/H4	0.171 - 0.181	3	0.220	0.165	2.382	1.024	5.486	9039070054860	●
1/4-20	H4/H5	0.196 - 0.207	3	0.255	0.191	2.500	1.181	6.350	9039070063500	●
5/16-18	H4/H5	0.252 - 0.265	3	0.318	0.238	2.721	1.377	7.938	9039070079380	●
3/8-16	H5/H6	0.307 - 0.321	3	0.381	0.286	2.941	1.456	9.525	9039070095250	●
7/16-14	H5/H6	0.360 - 0.376	3	0.323	0.242	3.161	N/A	11.113	9039070111130	●
1/2-13	H5/H6	0.417 - 0.434	3	0.367	0.275	3.382	N/A	12.700	9039070127000	●
9/16-12	H5/H6	0.472 - 0.490	3	0.429	0.322	3.591	N/A	14.288	9039070142880	●
5/8-11	H5/H6	0.527 - 0.546	3	0.480	0.360	3.811	N/A	15.875	9039070158750	●
3/4-10	H5/H6	0.642 - 0.663	4	0.590	0.442	4.252	N/A	19.050	9039070190500	●
7/8-9	H6/H7	0.755 - 0.778	4	0.697	0.523	4.689	N/A	22.225	9039070222250	●
1-8	H6/H7	0.865 - 0.890	4	0.800	0.600	5.130	N/A	25.400	9039070254000	●

UNC

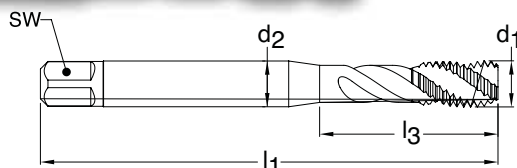

Series 3910
Standard ANSI
Tool Material HSS-E PM
Spiral Flute 40° Helix
Chamfer Form C • 2-3
Class of Fit 2B



Blind holes **TiN coated** **External cooling**

d1 - P	H Limits	Tap Drill Range inch	Number of Flutes	d2 inch	SW inch	l1 inch	l3 inch	Order Code	EDP Number	Stock
4-40	H2/H3	0.085 - 0.094	3	0.141	0.110	1.882	0.709	2.845	9039100028450	●
5-40	H2/H3	0.098 - 0.106	3	0.141	0.110	1.941	0.709	3.175	9039100031750	●
6-32	H3/H4	0.104 - 0.114	3	0.141	0.110	2.000	0.748	3.505	9039100035050	●
8-32	H3/H4	0.130 - 0.139	3	0.168	0.131	2.130	0.827	4.166	9039100041660	●
10-24	H3/H4	0.145 - 0.155	3	0.194	0.152	2.382	0.945	4.826	9039100048260	●
12-24	H3/H4	0.171 - 0.181	3	0.220	0.165	2.382	1.024	5.486	9039100054860	●
1/4-20	H4/H5	0.196 - 0.207	3	0.255	0.191	2.500	1.181	6.350	9039100063500	●
5/16-18	H4/H5	0.252 - 0.265	3	0.318	0.238	2.721	1.377	7.938	9039100079380	●
3/8-16	H5/H6	0.307 - 0.321	3	0.381	0.286	2.941	1.456	9.525	9039100095250	●
7/16-14	H5/H6	0.360 - 0.376	3	0.323	0.242	3.161	N/A	11.113	9039100111130	●
1/2-13	H5/H6	0.417 - 0.434	3	0.367	0.275	3.382	N/A	12.700	9039100127000	●
9/16-12	H5/H6	0.472 - 0.490	3	0.429	0.322	3.591	N/A	14.288	9039100142880	●
5/8-11	H5/H6	0.527 - 0.546	4	0.480	0.360	3.811	N/A	15.875	9039100158750	●
3/4-10	H5/H6	0.642 - 0.663	4	0.590	0.442	4.252	N/A	19.050	9039100190500	●
7/8-9	H6/H7	0.755 - 0.778	4	0.697	0.523	4.689	N/A	22.225	9039100222250	●
1-8	H6/H7	0.865 - 0.890	4	0.800	0.600	5.130	N/A	25.400	9039100254000	●

UNF

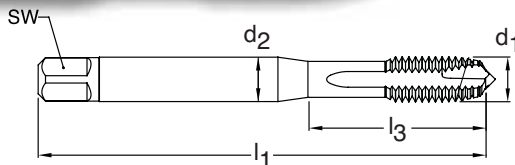

Series 3908
Standard ANSI
Tool Material HSS-E PM
Spiral Point Straight flute
Chamfer Form B • 3.5 - 5
Class of Fit 2B

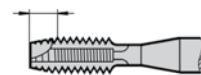

Through holes **TiN coated** **External cooling**

d1 - P	H Limits	Tap Drill Range inch	Number of Flutes	d2 inch	SW inch	l1 inch	l3 inch	Order Code	EDP Number	Stock
4-48	H2/H3	0.089 - 0.097	3	0.141	0.110	1.882	0.709	2.845	9039080028450	●
5-44	H2/H3	0.100 - 0.108	3	0.141	0.110	1.941	0.709	3.175	9039080031750	●
6-40	H2/H3	0.111 - 0.119	3	0.141	0.110	2.000	0.748	3.505	9039080035050	●
8-36	H2/H3	0.134 - 0.142	3	0.168	0.131	2.130	0.827	4.166	9039080041660	●
10-32	H3/H4	0.156 - 0.164	3	0.194	0.152	2.382	0.945	4.826	9039080048260	●
12-28	H3/H4	0.177 - 0.186	3	0.220	0.165	2.382	1.024	5.486	9039080054860	●
1/4-28	H3/H4	0.211 - 0.220	3	0.255	0.191	2.500	1.181	6.350	9039080063500	●
5/16-24	H3/H4	0.267 - 0.277	3	0.318	0.238	2.721	1.377	7.938	9039080079380	●
3/8-24	H3/H4	0.330 - 0.340	3	0.381	0.286	2.941	1.456	9.525	9039080095250	●
7/16-20	H4/H5	0.383 - 0.395	3	0.323	0.242	3.161	N/A	11.113	9039080111130	●
1/2-20	H4/H5	0.446 - 0.457	3	0.367	0.275	3.382	N/A	12.700	9039080127000	●
9/16-18	H4/H5	0.502 - 0.515	3	0.429	0.322	3.591	N/A	14.288	9039080142880	●
5/8-18	H4/H5	0.565 - 0.578	3	0.480	0.360	3.811	N/A	15.875	9039080158750	●
3/4-16	H5/H6	0.682 - 0.696	4	0.590	0.442	4.252	N/A	19.050	9039080190500	●
7/8-14	H6/H7	0.798 - 0.813	4	0.697	0.523	4.689	N/A	22.225	9039080222250	●
1-12	H6/H7	0.910 - 0.928	4	0.800	0.600	5.130	N/A	25.400	9039080254000	●

UNF

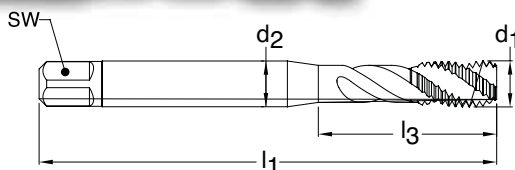

Series 3911
Standard ANSI
Tool Material HSS-E PM
Spiral Flute 40° Helix
Chamfer Form C • 2-3
Class of Fit 2B



Blind holes **TiN coated** **External cooling**

d1 - P	H Limits	Tap Drill Range inch	Number of Flutes	d2 inch	SW inch	l1 inch	l3 inch	Order Code	EDP Number	Stock
4-48	H2/H3	0.089 - 0.097	3	0.141	0.110	1.882	0.709	2.845	9039110028450	●
5-44	H2/H3	0.100 - 0.108	3	0.141	0.110	1.941	0.709	3.175	9039110031750	●
6-40	H2/H3	0.111 - 0.119	3	0.141	0.110	2.000	0.748	3.505	9039110035050	●
8-36	H2/H3	0.134 - 0.142	3	0.168	0.131	2.130	0.827	4.166	9039110041660	●
10-32	H3/H4	0.156 - 0.164	3	0.194	0.152	2.382	0.945	4.826	9039110048260	●
12-28	H3/H4	0.177 - 0.186	3	0.220	0.165	2.382	1.024	5.486	9039110054860	●
1/4-28	H3/H4	0.211 - 0.220	3	0.255	0.191	2.500	1.181	6.350	9039110063500	●
5/16-24	H3/H4	0.267 - 0.277	3	0.318	0.238	2.721	1.377	7.938	9039110079380	●
3/8-24	H3/H4	0.330 - 0.340	3	0.381	0.286	2.941	1.456	9.525	9039110095250	●
7/16-20	H4/H5	0.383 - 0.395	3	0.323	0.242	3.161	N/A	11.113	9039110111130	●
1/2-20	H4/H5	0.446 - 0.457	3	0.367	0.275	3.382	N/A	12.700	9039110127000	●
9/16-18	H4/H5	0.502 - 0.515	3	0.429	0.322	3.591	N/A	14.288	9039110142880	●
5/8-18	H4/H5	0.565 - 0.578	4	0.480	0.360	3.811	N/A	15.875	9039110158750	●
3/4-16	H5/H6	0.682 - 0.696	4	0.590	0.442	4.252	N/A	19.050	9039110190500	●
7/8-14	H6/H7	0.798 - 0.813	4	0.697	0.523	4.689	N/A	22.225	9039110222250	●
1-12	H6/H7	0.910 - 0.928	4	0.800	0.600	5.130	N/A	25.400	9039110254000	●

"Tap drill Range" given is per the Class of Fit shown per Series #
 Additional Tap Drill sizes & percent of thread engagement can be found on pages 229-237.

UNC

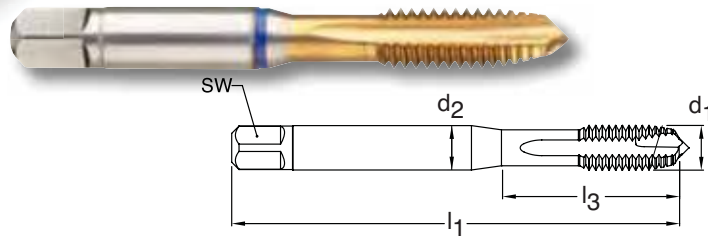

Series 3996
Standard ANSI
Tool Material HSS-E PM
Spiral Point Straight flute
Chamfer Form B • 3.5 - 5
Class of Fit 3B



Through holes **TiN coated** **External cooling**

d1 - P	H Limits	Tap Drill Range inch	Number of Flutes	d2 inch	SW inch	l1 inch	l3 inch	Order Code	EDP Number	Stock
4-40	H2	0.085 - 0.094	3	0.141	0.110	1.882	0.709	2.845	9039960028450	●
5-40	H2	0.098 - 0.106	3	0.141	0.110	1.941	0.709	3.175	9039960031750	●
6-32	H2	0.104 - 0.114	3	0.141	0.110	2.000	0.748	3.505	9039960035050	●
8-32	H2	0.130 - 0.139	3	0.168	0.131	2.130	0.827	4.166	9039960041660	●
10-24	H3	0.145 - 0.156	3	0.194	0.152	2.382	0.945	4.826	9039960048260	●
12-24	H3	0.171 - 0.181	3	0.220	0.165	2.382	1.024	5.486	9039960054860	●
1/4-20	H3	0.196 - 0.207	3	0.255	0.191	2.500	1.181	6.350	9039960063500	●
5/16-18	H3	0.252 - 0.263	3	0.318	0.238	2.721	1.377	7.938	9039960079380	●
3/8-16	H3	0.307 - 0.318	3	0.381	0.286	2.941	1.456	9.525	9039960095250	●
7/16-14	H3	0.360 - 0.372	3	0.323	0.242	3.161	N/A	11.113	9039960111130	●
1/2-13	H3	0.417 - 0.428	4	0.367	0.275	3.382	N/A	12.700	9039960127000	●
9/16-12	H3	0.472 - 0.484	4	0.429	0.322	3.591	N/A	14.288	9039960142880	●
5/8-11	H3	0.527 - 0.539	4	0.480	0.360	3.811	N/A	15.875	9039960158750	●
3/4-10	H4	0.642 - 0.655	4	0.590	0.442	4.252	N/A	19.050	9039960190500	●
1-8	H4	0.865 - 0.880	4	0.800	0.600	5.130	N/A	25.400	9039960254000	●

UNC

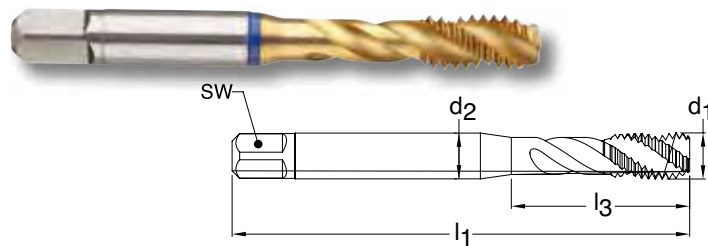

Series 3998
Standard ANSI
Tool Material HSS-E PM
Spiral Flute 40° Helix
Chamfer Form C • 2-3
Class of Fit 3B



Blind holes **TiN coated** **External cooling**

d1 - P	H Limits	Tap Drill Range inch	Number of Flutes	d2 inch	SW inch	l1 inch	l3 inch	Order Code	EDP Number	Stock
4-40	H2	0.085 - 0.094	3	0.141	0.110	1.882	0.709	2.845	9039980028450	●
5-40	H2	0.098 - 0.106	3	0.141	0.110	1.941	0.709	3.175	9039980031750	●
6-32	H2	0.104 - 0.114	3	0.141	0.110	2.000	0.748	3.505	9039980035050	●
8-32	H2	0.130 - 0.139	3	0.168	0.131	2.130	0.827	4.166	9039980041660	●
10-24	H3	0.145 - 0.156	3	0.194	0.152	2.382	0.945	4.826	9039980048260	●
12-24	H3	0.171 - 0.181	3	0.220	0.165	2.382	1.024	5.486	9039980054860	●
1/4-20	H3	0.196 - 0.207	3	0.255	0.191	2.500	1.181	6.350	9039980063500	●
5/16-18	H3	0.252 - 0.263	3	0.318	0.238	2.721	1.377	7.938	9039980079380	●
3/8-16	H3	0.307 - 0.318	3	0.381	0.286	2.941	1.456	9.525	9039980095250	●
7/16-14	H3	0.360 - 0.372	3	0.323	0.242	3.161	N/A	11.113	9039980111130	●
1/2-13	H3	0.417 - 0.428	3	0.367	0.275	3.382	N/A	12.700	9039980127000	●
9/16-12	H3	0.472 - 0.484	3	0.429	0.322	3.591	N/A	14.288	9039980142880	●
5/8-11	H3	0.527 - 0.539	4	0.480	0.360	3.811	N/A	15.875	9039980158750	●
3/4-10	H4	0.642 - 0.655	4	0.590	0.442	4.252	N/A	19.050	9039980190500	●
1-8	H4	0.865 - 0.880	4	0.800	0.600	5.130	N/A	25.400	9039980254000	●

UNF

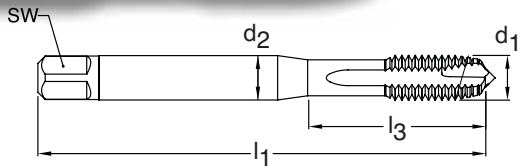

Series 3997
Standard ANSI
Tool Material HSS-E PM
Spiral Point Straight flute
Chamfer Form B • 3.5 - 5
Class of Fit 3B



Through holes



TiN coated



External cooling

d1 - P	H Limits	Tap Drill Range inch	Number of Flutes	d2 inch	SW inch	l1 inch	l3 inch	Order Code	EDP Number	Stock
4-48	H2	0.089 - 0.097	3	0.141	0.110	1.882	0.709	2.845	9039970028450	●
5-44	H2	0.100 - 0.108	3	0.141	0.110	1.941	0.709	3.175	9039970031750	●
6-40	H2	0.111 - 0.119	3	0.141	0.110	2.000	0.748	3.505	9039970035050	●
8-36	H2	0.134 - 0.142	3	0.168	0.131	2.130	0.827	4.166	9039970041660	●
10-32	H3	0.156 - 0.164	3	0.194	0.152	2.382	0.945	4.826	9039970048260	●
12-28	H3	0.177 - 0.186	3	0.220	0.165	2.382	1.024	5.486	9039970054860	●
1/4-28	H3	0.211 - 0.219	3	0.255	0.191	2.500	1.181	6.350	9039970063500	●
5/16-24	H3	0.267 - 0.275	3	0.318	0.238	2.721	1.377	7.938	9039970079380	●
3/8-24	H3	0.330 - 0.337	3	0.381	0.286	2.941	1.456	9.525	9039970095250	●
7/16-20	H3	0.383 - 0.392	3	0.323	0.242	3.161	N/A	11.113	9039970111130	●
1/2-20	H3	0.446 - 0.454	4	0.367	0.275	3.382	N/A	12.700	9039970127000	●
9/16-18	H3	0.502 - 0.511	4	0.429	0.322	3.591	N/A	14.288	9039970142880	●
5/8-18	H3	0.565 - 0.573	4	0.480	0.360	3.811	N/A	15.875	9039970158750	●
3/4-16	H3	0.682 - 0.691	4	0.590	0.442	4.252	N/A	19.050	9039970190500	●
1-12	H4	0.910 - 0.920	4	0.800	0.600	5.130	N/A	25.400	9039970254000	●

UNF

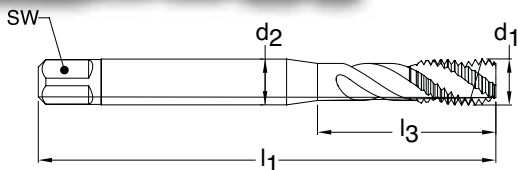

Series 3999
Standard ANSI
Tool Material HSS-E PM
Spiral Point 40° Helix
Chamfer Form C • 2-3
Class of Fit 3B



Blind holes



TiN coated



External cooling

d1 - P	H Limits	Tap Drill Range inch	Number of Flutes	d2 inch	SW inch	l1 inch	l3 inch	Order Code	EDP Number	Stock
4-48	H2	0.089 - 0.097	3	0.141	0.110	1.882	0.709	2.845	9039990028450	●
5-44	H2	0.100 - 0.108	3	0.141	0.110	1.941	0.709	3.175	9039990031750	●
6-40	H2	0.111 - 0.119	3	0.141	0.110	2.000	0.748	3.505	9039990035050	●
8-36	H2	0.134 - 0.142	3	0.168	0.131	2.130	0.827	4.166	9039990041660	●
10-32	H3	0.156 - 0.164	3	0.194	0.152	2.382	0.945	4.826	9039990048260	●
12-28	H3	0.177 - 0.186	3	0.220	0.165	2.382	1.024	5.486	9039990054860	●
1/4-28	H3	0.211 - 0.219	3	0.255	0.191	2.500	1.181	6.350	9039990063500	●
5/16-24	H3	0.267 - 0.275	3	0.318	0.238	2.721	1.377	7.938	9039990079380	●
3/8-24	H3	0.330 - 0.337	3	0.381	0.286	2.941	1.456	9.525	9039990095250	●
7/16-20	H3	0.383 - 0.392	3	0.323	0.242	3.161	N/A	11.113	9039990111130	●
1/2-20	H3	0.446 - 0.454	3	0.367	0.275	3.382	N/A	12.700	9039990127000	●
9/16-18	H3	0.502 - 0.511	3	0.429	0.322	3.591	N/A	14.288	9039990142880	●
5/8-18	H3	0.565 - 0.573	4	0.480	0.360	3.811	N/A	15.875	9039990158750	●
3/4-16	H3	0.682 - 0.691	4	0.590	0.442	4.252	N/A	19.050	9039990190500	●
1-12	H4	0.910 - 0.920	4	0.800	0.600	5.130	N/A	25.400	9039990254000	●

"Tap drill Range" given is per the Class of Fit shown per Series #
 Additional Tap Drill sizes & percent of thread engagement can be found on pages 229-237.

METRIC

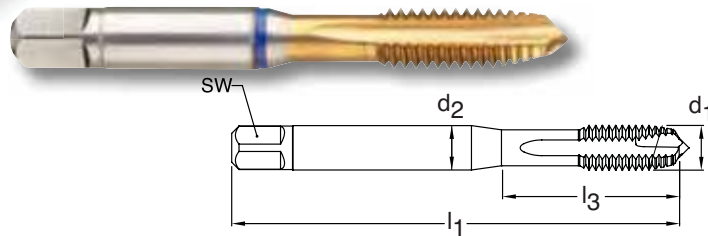

Series 3906
Standard ANSI
Tool Material HSS-E PM
Spiral Point Straight flute
Chamfer Form B • 3.5 - 5
Class of Fit ISO 2(6H)



Through holes **TiN coated** **External cooling**

d1 - P	D Limits	Tap Drill Range mm	Number of Flutes	d2 inch	SW inch	l1 inch	l3 inch	Order Code	EDP Number	Stock
M2 X 0.40	D2/D3	1.567 - 1.679	3	0.141	0.110	1.752	0.441	2.000	9039060020000	●
M3 X 0.50	D2/D3	2.459 - 2.599	3	0.141	0.110	1.941	0.709	3.000	9039060030000	●
M4 X 0.70	D3/D4	3.242 - 3.422	3	0.168	0.131	2.130	0.827	4.000	9039060040000	●
M5 X 0.80	D3/D4	4.134 - 4.334	3	0.194	0.152	2.382	0.945	5.000	9039060050000	●
M6 X 1.00	D4/D5	4.917 - 5.153	3	0.255	0.191	2.500	1.181	6.000	9039060060000	●
M8 X 1.25	D4/D5	6.647 - 6.912	3	0.318	0.238	2.721	1.377	8.000	9039060080000	●
M10 X 1.50	D4/D5	8.376 - 8.676	3	0.381	0.286	2.941	1.456	10.000	9039060100000	●
M12 X 1.75	D5/D6	10.106 - 10.441	3	0.367	0.275	3.382	N/A	12.000	9039060120000	●
M14 X 2.00	D5/D6	11.835 - 12.210	3	0.429	0.322	3.591	N/A	14.000	9039060140000	●
M16 X 2.00	D6/D7	13.835 - 14.210	3	0.480	0.360	3.811	N/A	16.000	9039060160000	●
M18 X 2.50	D6/D7	15.294 - 15.744	4	0.542	0.406	4.032	N/A	18.000	9039060180000	●
M20 X 2.50	D6/D7	17.294 - 17.744	4	0.652	0.489	4.469	N/A	20.000	9039060200000	●

METRIC

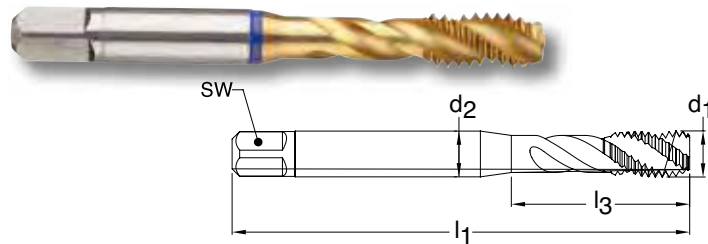

Series 3909
Standard ANSI
Tool Material HSS-E PM
Spiral Flute 40° Helix
Chamfer Form C • 2-3
Class of Fit ISO2 (6H)

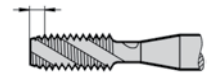

Blind holes **TiN coated** **External cooling**

d1 - P	D Limits	Tap Drill Range mm	Number of Flutes	d2 inch	SW inch	l1 inch	l3 inch	Order Code	EDP Number	Stock
M2 X 0.40	D2/D3	1.567 - 1.679	3	0.141	0.110	1.752	0.441	2.000	9039090020000	●
M3 X 0.50	D2/D3	2.459 - 2.599	3	0.141	0.110	1.941	0.709	3.000	9039090030000	●
M4 X 0.70	D3/D4	3.242 - 3.422	3	0.168	0.131	2.130	0.827	4.000	9039090040000	●
M5 X 0.80	D3/D4	4.134 - 4.334	3	0.194	0.152	2.382	0.945	5.000	9039090050000	●
M6 X 1.00	D4/D5	4.917 - 5.153	3	0.255	0.191	2.500	1.181	6.000	9039090060000	●
M8 X 1.25	D4/D5	6.647 - 6.912	3	0.318	0.238	2.721	1.377	8.000	9039090080000	●
M10 X 1.50	D4/D5	8.376 - 8.676	3	0.381	0.286	2.941	1.456	10.000	9039090100000	●
M12 X 1.75	D5/D6	10.106 - 10.441	3	0.367	0.275	3.382	N/A	12.000	9039090120000	●
M14 X 2.00	D5/D6	11.835 - 12.210	3	0.429	0.322	3.591	N/A	14.000	9039090140000	●
M16 X 2.00	D6/D7	13.835 - 14.210	4	0.480	0.360	3.811	N/A	16.000	9039090160000	●
M18 X 2.50	D6/D7	15.294 - 15.744	4	0.542	0.406	4.032	N/A	18.000	9039090180000	●
M20 X 2.50	D6/D7	17.294 - 17.744	4	0.652	0.489	4.469	N/A	20.000	9039090200000	●

METRIC

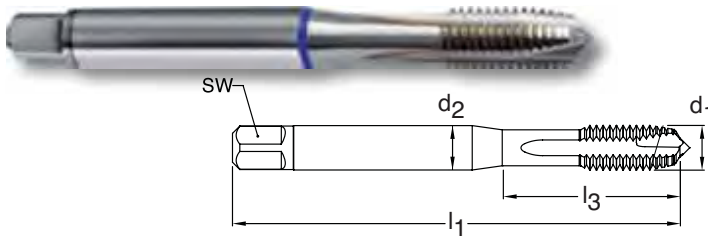

Series 877
Standard DIN 371
Tool Material HSS-E PM
Spiral Point Straight flute
Chamfer Form B • 3.5 - 5
Class of Fit ISO 2(6H)



Through holes
 Bright finish
 External cooling

d1 - P	D Limits	Tap Drill Range mm	Number of Flutes	d2 mm	SW mm	l1 mm	l3 mm	Order Code	EDP Number	Stock
M2 X 0.40	D2/D3	1.567 - 1.679	3	2.80	2.10	45.00	13.50	2.000	9008770020000	○
M2.5 X 0.45	D2/D3	2.013 - 2.138	3	2.80	2.10	50.00	14.50	2.500	9008770025000	○
M3 X 0.50	D2/D3	2.459 - 2.599	3	3.50	2.70	56.00	18.00	3.000	9008770030000	●
M4 X 0.70	D3/D4	3.242 - 3.422	3	4.50	3.40	63.00	21.00	4.000	9008770040000	●
M5 X 0.80	D3/D4	4.134 - 4.334	3	6.00	4.90	70.00	25.00	5.000	9008770050000	●
M6 X 1.00	D4/D5	4.917 - 5.153	3	6.00	4.90	80.00	30.00	6.000	9008770060000	●
M8 X 1.25	D4/D5	6.647 - 6.912	3	8.00	6.20	90.00	35.00	8.000	9008770080000	●
M10 X 1.50	D4/D5	8.376 - 8.676	3	10.00	8.00	100.00	39.00	10.000	9008770100000	●

METRIC

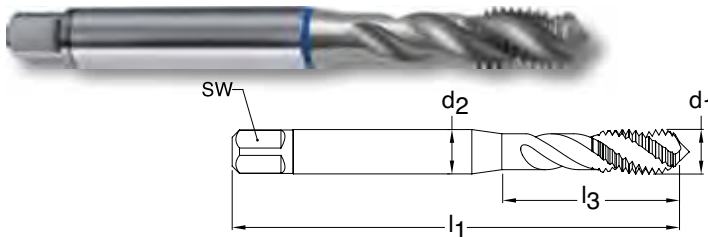

Series 909
Standard DIN 371
Tool Material HSS-E PM
Spiral Flute 40° Helix
Chamfer Form C • 2-3
Class of Fit ISO2 (6H)

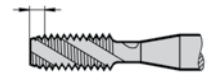

Blind holes
 Bright finish
 External cooling

d1 - P	D Limits	Tap Drill Range mm	Number of Flutes	d2 mm	SW mm	l1 mm	l3 mm	Order Code	EDP Number	Stock
M3 X 0.50	D2/D3	2.459 - 2.599	3	3.50	2.70	56.00	18.00	3.000	9009090030000	●
M4 X 0.70	D3/D4	3.242 - 3.422	3	4.50	3.40	63.00	21.00	4.000	9009090040000	○
M5 X 0.80	D3/D4	4.134 - 4.334	3	6.00	4.90	70.00	25.00	5.000	9009090050000	●
M6 X 1.00	D4/D5	4.917 - 5.153	3	6.00	4.90	80.00	30.00	6.000	9009090060000	●
M8 X 1.25	D4/D5	6.647 - 6.912	3	8.00	6.20	90.00	35.00	8.000	9009090080000	●
M10 X 1.50	D4/D5	8.376 - 8.676	3	10.00	8.00	100.00	39.00	10.000	9009090100000	●

"Tap drill Range" given is per the Class of Fit shown per Series #
 Additional Tap Drill sizes & percent of thread engagement can be found on pages 229-237.

METRIC

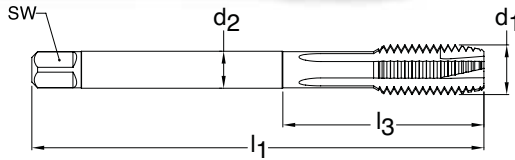

Series 1872
Standard DIN 376
Tool Material HSS-E (Cobalt)
Spiral Point Straight flute
Chamfer Form B • 3.5 - 5
Class of Fit ISO 2(6H)



Through holes **Bright finish** **External cooling**

d1 - P	D Limits	Tap Drill Range mm	Number of Flutes	d2 mm	SW mm	l1 mm	l3 mm	Order Code	EDP Number	Stock
M3 X 0.50	D2/D3	2.459 - 2.599	3	2.20	N/A	56.00	N/A	3.000	9018720030000	●
M4 X 0.70	D3/D4	3.242 - 3.422	3	2.80	2.10	63.00	N/A	4.000	9018720040000	●
M5 X 0.80	D3/D4	4.134 - 4.334	3	3.50	2.70	70.00	N/A	5.000	9018720050000	●
M6 X 1.00	D4/D5	4.917 - 5.153	3	4.50	3.40	80.00	N/A	6.000	9018720060000	●
M8 X 1.25	D4/D5	6.647 - 6.912	3	6.00	4.90	90.00	N/A	8.000	9018720080000	●
M10 X 1.50	D4/D5	8.376 - 8.676	3	7.00	5.50	100.00	N/A	10.000	9018720100000	●
M12 X 1.75	D5/D6	10.106 - 10.441	4	9.00	7.00	110.00	N/A	12.000	9018720120000	●
M14 X 2.00	D5/D6	11.835 - 12.210	4	11.00	9.00	110.00	N/A	14.000	9018720140000	○
M16 X 2.00	D6/D7	13.835 - 14.210	4	12.00	9.00	110.00	N/A	16.000	9018720160000	●
M18 X 2.50	D6/D7	15.294 - 15.744	4	14.00	11.00	125.00	N/A	18.000	9018720180000	●
M20 X 2.50	D6/D7	17.294 - 17.744	4	16.00	12.00	140.00	N/A	20.000	9018720200000	●
M22 X 2.50	D6/D7	19.294 - 19.744	4	18.00	14.50	140.00	N/A	22.000	9018720220000	○
M24 X 3.00	D7/D8	20.752 - 21.252	4	18.00	14.50	160.00	N/A	24.000	9018720240000	●
M30 X 3.50	D8/D9	26.211 - 26.771	4	22.00	18.00	180.00	N/A	30.000	9018720300000	●

METRIC FINE

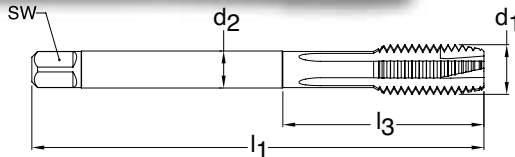

Series 1873
Standard DIN 374
Tool Material HSS-E (Cobalt)
Spiral Point Straight flute
Chamfer Form B • 3.5 - 5
Class of Fit ISO 2(6H)



Through holes **Bright finish** **External cooling**

d1 - P	D Limits	Tap Drill Range mm	Number of Flutes	d2 mm	SW mm	l1 mm	l3 mm	Order Code	EDP Number	Stock
M10 X 1.00	D4/D5	8.917 - 9.153	3	7.00	5.50	90.00	N/A	10.005	9018730100050	●
M12 X 1.00	D4/D5	10.917 - 11.153	4	9.00	7.00	100.00	N/A	12.005	9018730120050	○
M14 X 1.50	D4/D5	12.376 - 12.676	4	11.00	9.00	100.00	N/A	14.007	9018730140070	●
M16 X 1.50	D4/D5	14.376 - 14.676	4	12.00	9.00	100.00	N/A	16.007	9018730160070	○
M18 X 1.50	D4/D5	16.376 - 16.676	4	14.00	11.00	110.00	N/A	18.007	9018730180070	○

METRIC

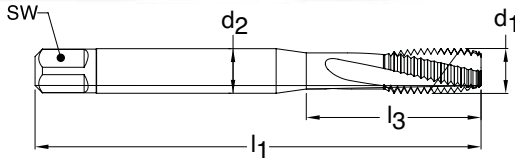

Series 2896
Standard DIN 371
Tool Material HSS-E (Cobalt)
Spiral Flute 15° Helix
Chamfer Form C • 2-3
Class of Fit ISO2 (6H)

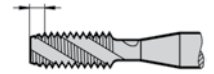

Blind holes



TiN coated



External cooling

d1 - P	D Limits	Tap Drill Range mm	Number of Flutes	d2 mm	SW mm	l1 mm	l3 mm	Order Code	EDP Number	Stock
M3 X 0.50	D2/D3	2.459 - 2.599	3	3.50	2.70	56.00	18.00	3.000	9028960030000	●
M4 X 0.70	D3/D4	3.242 - 3.422	3	4.50	3.40	63.00	21.00	4.000	9028960040000	●
M5 X 0.80	D3/D4	4.134 - 4.334	3	6.00	4.90	70.00	25.00	5.000	9028960050000	●
M6 X 1.00	D4/D5	4.917 - 5.153	3	6.00	4.90	80.00	30.00	6.000	9028960060000	●
M8 X 1.25	D4/D5	6.647 - 6.912	3	8.00	6.20	90.00	35.00	8.000	9028960080000	●
M10 X 1.50	D4/D5	8.376 - 8.676	3	10.00	8.00	100.00	39.00	10.000	9028960100000	○

METRIC

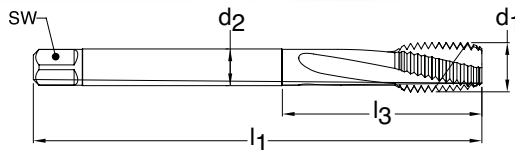

Series 2895
Standard DIN 376
Tool Material HSS-E (Cobalt)
Spiral Flute 15° Helix
Chamfer Form C • 2-3
Class of Fit ISO2 (6H)

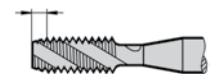

Blind holes



TiN coated



External cooling

d1 - P	D Limits	Tap Drill Range mm	Number of Flutes	d2 mm	SW mm	l1 mm	l3 mm	Order Code	EDP Number	Stock
M12 X 1.75	D5/D6	10.106 - 10.441	3	9.00	7.00	110.00	N/A	12.000	9028950120000	○
M16 X 2.00	D6/D7	13.835 - 14.210	4	12.00	9.00	110.00	N/A	16.000	9028950160000	●
M20 X 2.50	D6/D7	17.294 - 17.744	4	16.00	12.00	140.00	N/A	20.000	9028950200000	●
M22 X 2.50	D6/D7	19.294 - 19.744	4	18.00	14.50	140.00	N/A	22.000	9028950220000	●
M24 X 3.00	D7/D8	20.752 - 21.252	4	18.00	14.50	160.00	N/A	24.000	9028950240000	●

METRIC FINE

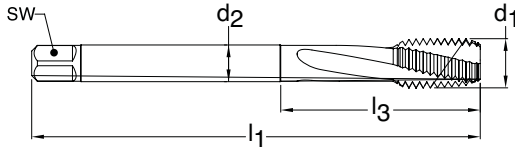

Series 2897
Standard DIN 374
Tool Material HSS-E (Cobalt)
Spiral Flute 15° Helix
Chamfer Form C • 2-3
Class of Fit ISO2 (6H)



Blind holes



TiN coated



External cooling

d1 - P	D Limits	Tap Drill Range mm	Number of Flutes	d2 mm	SW mm	l1 mm	l3 mm	Order Code	EDP Number	Stock
M4 X 0.50	D3/D4	3.459 - 3.599	3	2.80	2.10	63.00	N/A	4.003	9028970040030	○
M5 X 0.50	D3/D4	4.459 - 4.599	3	3.50	2.70	70.00	N/A	5.003	9028970050030	○
M6 X 0.50	D3/D4	5.460 - 5.600	3	4.50	3.40	80.00	N/A	6.003	9028970060030	○
M8 X 1.00	D4/D5	6.917 - 7.153	3	6.00	4.90	90.00	N/A	8.005	9028970080050	●
M10 X 1.00	D4/D5	8.917 - 9.153	3	7.00	5.50	90.00	N/A	10.005	9028970100050	○
M12 X 1.00	D4/D5	10.917 - 11.153	3	9.00	7.00	100.00	N/A	12.005	9028970120050	○
M12 X 1.50	D4/D5	10.376 - 10.676	3	9.00	7.00	100.00	N/A	12.007	9028970120070	○
M14 X 1.50	D4/D5	12.376 - 12.676	3	11.00	9.00	100.00	N/A	14.007	9028970140070	●
M16 X 1.50	D4/D5	14.376 - 14.676	4	12.00	9.00	100.00	N/A	16.007	9028970160070	●
M18 X 1.50	D4/D5	16.376 - 16.676	4	14.00	11.00	110.00	N/A	18.007	9028970180070	●
M20 X 2.00	D6/D7	17.835 - 18.210	4	16.00	12.00	140.00	N/A	20.008	9028970200080	○
M22 X 1.50	D6/D7	20.376 - 20.676	4	18.00	14.50	125.00	N/A	22.007	9028970220070	●
M24 X 1.50	D6/D7	22.376 - 22.676	4	18.00	14.50	140.00	N/A	24.007	9028970240070	○

METRIC

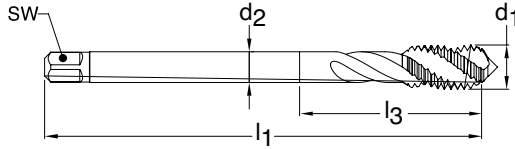

Series 910
Standard DIN 376
Tool Material HSS-E PM
Spiral Flute 40° Helix
Chamfer Form C • 2-3
Class of Fit ISO2 (6H)



Blind holes



Bright finish



External cooling

d1 - P	D Limits	Tap Drill Range mm	Number of Flutes	d2 mm	SW mm	l1 mm	l3 mm	Order Code	EDP Number	Stock
M12 X 1.75	D5/D6	10.106 - 10.441	3	9.00	7.00	110.00	N/A	12.000	9009100120000	●
M14 X 2.00	D5/D6	11.835 - 12.210	3	11.00	9.00	110.00	N/A	14.000	9009100140000	○
M16 X 2.00	D6/D7	13.835 - 14.210	4	12.00	9.00	110.00	N/A	16.000	9009100160000	●
M20 X 2.50	D6/D7	17.294 - 17.744	4	16.00	12.00	140.00	N/A	20.000	9009100200000	○
M24 X 3.00	D7/D8	20.752 - 21.252	4	18.00	14.50	160.00	N/A	24.000	9009100240000	●

METRIC FINE

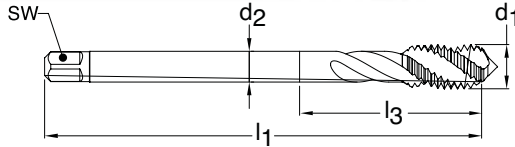

Series 936
Standard DIN 374
Tool Material HSS-E PM
Spiral Flute 40° Helix
Chamfer Form C • 2-3
Class of Fit ISO2 (6H)



Blind holes



Bright finish



External cooling

d1 - P	D Limits	Tap Drill Range mm	Number of Flutes	d2 mm	SW mm	l1 mm	l3 mm	Order Code	EDP Number	Stock
M8 X 1.00	D4/D5	6.917 - 7.153	3	6.00	4.90	90.00	N/A	8.005	9009360080050	●
M10 X 1.00	D4/D5	8.917 - 9.153	3	7.00	5.50	90.00	N/A	10.005	9009360100050	●
M12 X 1.00	D4/D5	10.917 - 11.153	3	9.00	7.00	100.00	N/A	12.005	9009360120050	○
M12 X 1.50	D4/D5	10.376 - 10.676	3	9.00	7.00	100.00	N/A	12.007	9009360120070	●
M14 X 1.50	D4/D5	12.376 - 12.676	3	11.00	9.00	100.00	N/A	14.007	9009360140070	●
M16 X 1.50	D4/D5	14.376 - 14.676	4	12.00	9.00	100.00	N/A	16.007	9009360160070	●
M18 X 1.50	D4/D5	16.376 - 16.676	4	14.00	11.00	110.00	N/A	18.007	9009360180070	●
M20 X 1.50	D6/D7	18.376 - 18.676	4	16.00	12.00	125.00	N/A	20.007	9009360200070	○

"Tap drill Range" given is per the Class of Fit shown per Series #
 Additional Tap Drill sizes & percent of thread engagement can be found on pages 229-237.

NPT

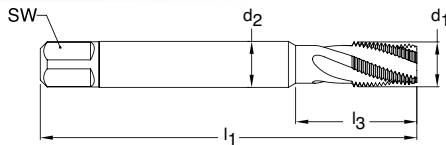

Series 1088
Standard Guhring Standard
Tool Material HSS-E (Cobalt)
Spiral Flute 25° Helix
Chamfer Form C • 2-3



Through holes **Blind holes** **TiN coated** **External cooling**

d1 - P	Tap Drill Range	Number of Flutes	d2 mm	SW mm	l1 mm	l3 mm	Order Code	EDP Number	Stock
1/16-27		4	8.00	6.20	90.00	N/A	8.190	9010880081900	●
1/8-27		4	11.00	9.00	90.00	N/A	10.620	9010880106200	●
1/4-18	See Chart Below	5	14.00	11.00	100.00	N/A	14.140	9010880141400	●
3/8-18		5	16.00	12.00	110.00	N/A	17.570	9010880175700	●
1/2-14		5	18.00	14.50	125.00	N/A	21.900	9010880219000	●
3/4-14		5	22.00	18.00	140.00	N/A	27.230	9010880272300	●
1 11-1/2		5	25.00	20.00	170.00	N/A	34.180	9010880341800	●

NPTF

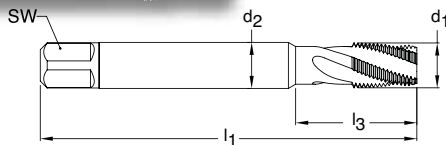

Series 4127
Standard Guhring Standard
Tool Material HSS-E (Cobalt)
Spiral Flute 25° Helix
Chamfer Form C • 2-3



Through holes **Blind holes** **TiN coated** **External cooling**

d1 - P	Tap Drill Range	Number of Flutes	d2 mm	SW mm	l1 mm	l3 mm	Order Code	EDP Number	Stock
1/16-27		4	8.00	6.20	90.00	N/A	8.190	9041270081900	●
1/8-27		4	11.00	9.00	90.00	N/A	10.620	9041270106200	●
1/4-18	See Chart Below	5	14.00	11.00	100.00	N/A	14.140	9041270141400	●
3/8-18		5	16.00	12.00	110.00	N/A	17.570	9041270175700	●
1/2-14		5	18.00	14.50	125.00	N/A	21.900	9041270219000	●
3/4-14		5	22.00	18.00	140.00	N/A	27.230	9041270272300	●
1 11-1/2		5	25.00	20.00	170.00	N/A	34.180	9041270341800	●

NPT

Drilling cylindrically without using a reamer

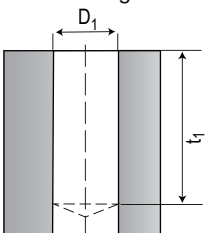

Drilling cylindrically and reaming conically using a reamer

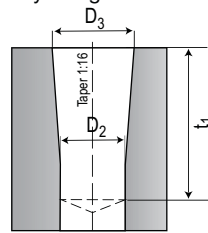

Nominal Size	Threads per Inch	D1 inch	D2 inch	D3 inch	t1 inch
1/16	27	0.2421	0.2343	0.2516	0.4724
1/8	27	0.3346	0.3248	0.3441	0.4724
1/4	18	0.4331	0.4232	0.4472	0.6890
3/8	18	0.5709	0.5551	0.5827	0.6929
1/2	14	0.7028	0.6890	0.7213	0.9016
3/4	14	0.9134	0.8937	0.9319	0.9055
1	11 1/2	1.1417	1.1260	1.1689	1.0787
1 1/4	11 1/2	1.4882	1.4685	1.5138	1.1063
1 1/2	11 1/2	1.7323	1.7087	1.7528	1.1181
2	11 1/2	2.2047	2.1850	2.2268	1.1181

NPTF

Drilling cylindrically without using a reamer

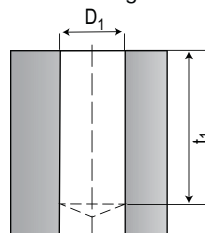

Drilling cylindrically and reaming conically using a reamer

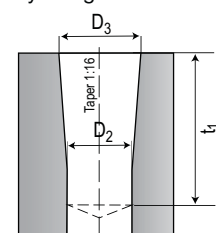

Nominal Size	Threads per Inch	D1 inch	D2 inch	D3 inch	t1 inch
1/16	27	0.2402	0.2343	0.2524	0.4724
1/8	27	0.3327	0.3248	0.3449	0.4724
1/4	18	0.4291	0.4232	0.4488	0.6890
3/8	18	0.5630	0.5551	0.5843	0.6929
1/2	14	0.6929	0.6890	0.7217	0.9016
3/4	14	0.9055	0.8937	0.9323	0.9055
1	11 1/2	1.1319	1.1260	1.1701	1.0787
1 1/4	11 1/2	1.4764	1.4685	1.5150	1.1063
1 1/2	11 1/2	1.7224	1.7087	1.7539	1.1181
2	11 1/2	2.1949	2.1850	2.2280	1.1181

TM

Tool Management
Powered by

GUHRING

Flexible
Professional
Sustainable





RED RING CUT TAPS

Alloyed case hardened steels

Alloyed heat-treatable steels

Alloyed tool steels

High speed tool steels

Material group	Approximate Rc	Approximate HB	Recommended SFM					
			HSS-E		HSS-E-PM		Solid carbide	
			bright finish	hard coated	bright finish	hard coated	bright finish	hard coated
Alloyed case hardened steels	<25	<250	25-35	30-50	30-50	35-70	—	—
Alloyed heat-treatable steels	<30	<280	15-30	30-40	25-45	35-65	—	—
Alloyed tool steels	<35	<320	10-20	20-40	20-45	30-60	—	—
High speed tool steels	<38	<380	8-15	10-30	15-35	25-55	—	—
	<44	<415	—	—	4-10	8-15	—	8-16
	<60	—	—	—	—	4-10	—	6-12

UNC

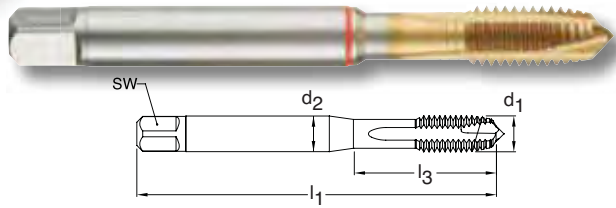

Series 3992
Standard DIN/ANSI
Tool Material HSS-E PM
Spiral Point Straight flute
Chamfer Form B • 3.5 - 5
Class of Fit 2B

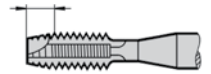

Through holes



TiN coated



External cooling

d1 - P	H Limits	Tap Drill Range inch	Number of Flutes	d2 inch	SW inch	l1 inch	l3 inch	Order Code	EDP Number	Stock
4-40	H2/H3	0.085 - 0.094	3	0.141	0.110	2.205	0.709	2.845	9039920028450	●
5-40	H2/H3	0.098 - 0.106	3	0.141	0.110	2.205	0.709	3.175	9039920031750	●
6-32	H3/H4	0.104 - 0.114	3	0.141	0.110	2.205	0.748	3.505	9039920035050	●
8-32	H3/H4	0.130 - 0.139	3	0.168	0.131	2.480	0.827	4.166	9039920041660	●
10-24	H3/H4	0.145 - 0.155	3	0.194	0.152	2.756	0.945	4.826	9039920048260	●
12-24	H3/H4	0.171 - 0.181	3	0.220	0.165	3.150	1.024	5.486	9039920054860	●
1/4-20	H4/H5	0.196 - 0.207	3	0.255	0.191	3.150	1.181	6.350	9039920063500	●
5/16-18	H4/H5	0.252 - 0.265	3	0.318	0.238	3.543	1.377	7.938	9039920079380	●
3/8-16	H5/H6	0.307 - 0.321	3	0.381	0.286	3.937	1.456	9.525	9039920095250	●
7/16-14	H5/H6	0.360 - 0.376	3	0.323	0.242	3.937	N/A	11.113	9039920111130	●
1/2-13	H5/H6	0.417 - 0.434	4	0.367	0.275	4.331	N/A	12.700	9039920127000	●
9/16-12	H5/H6	0.472 - 0.490	4	0.429	0.322	4.331	N/A	14.288	9039920142880	●
5/8-11	H5/H6	0.527 - 0.546	4	0.480	0.360	4.331	N/A	15.875	9039920158750	●
3/4-10	H5/H6	0.642 - 0.663	4	0.590	0.442	4.921	N/A	19.050	9039920190500	●
7/8-9	H6/H7	0.755 - 0.778	4	0.697	0.523	5.512	N/A	22.225	9039920222250	●
1-8	H6/H7	0.865 - 0.890	4	0.800	0.600	6.299	N/A	25.400	9039920254000	●
1 1/8-7	H7/H8	0.970 - 0.998	4	0.896	0.672	7.087	N/A	28.575	9039920285750	●
1 1/4-7	H7/H8	1.095 - 1.123	4	1.021	0.766	7.087	N/A	31.750	9039920317500	●
1 3/8-6	H7/H8	1.195 - 1.225	5	1.108	0.831	7.874	N/A	34.925	9039920349250	●
1 1/2-6	H7/H8	1.320 - 1.350	5	1.233	0.925	7.874	N/A	38.100	9039920381000	●

UNC

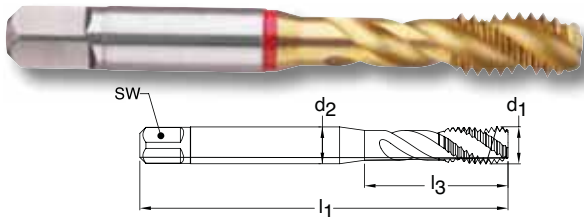

Series 3993
Standard DIN/ANSI
Tool Material HSS-E PM
Spiral Flute 40° Helix
Chamfer Form C • 2-3
Class of Fit 2B

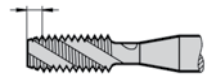

Blind holes



TiN coated



External cooling

d1 - P	H Limits	Tap Drill Range inch	Number of Flutes	d2 inch	SW inch	l1 inch	l3 inch	Order Code	EDP Number	Stock
4-40	H2/H3	0.085 - 0.094	3	0.141	0.110	2.205	0.709	2.845	9039930028450	●
5-40	H2/H3	0.098 - 0.106	3	0.141	0.110	2.205	0.709	3.175	9039930031750	●
6-32	H3/H4	0.104 - 0.114	3	0.141	0.110	2.205	0.748	3.505	9039930035050	●
8-32	H3/H4	0.130 - 0.139	3	0.168	0.131	2.480	0.827	4.166	9039930041660	●
10-24	H3/H4	0.145 - 0.155	3	0.194	0.152	2.756	0.945	4.826	9039930048260	●
12-24	H3/H4	0.171 - 0.181	3	0.220	0.165	3.150	1.024	5.486	9039930054860	●
1/4-20	H4/H5	0.196 - 0.207	3	0.255	0.191	3.150	1.181	6.350	9039930063500	●
5/16-18	H4/H5	0.252 - 0.265	3	0.318	0.238	3.543	1.377	7.938	9039930079380	●
3/8-16	H5/H6	0.307 - 0.321	3	0.381	0.286	3.937	1.456	9.525	9039930095250	●
7/16-14	H5/H6	0.360 - 0.376	3	0.323	0.242	3.937	N/A	11.113	9039930111130	●
1/2-13	H5/H6	0.417 - 0.434	3	0.367	0.275	4.331	N/A	12.700	9039930127000	●
9/16-12	H5/H6	0.502 - 0.515	3	0.429	0.322	4.331	N/A	14.288	9039930142880	●
5/8-11	H5/H6	0.527 - 0.546	4	0.480	0.360	4.331	N/A	15.875	9039930158750	●
3/4-10	H5/H6	0.642 - 0.663	4	0.590	0.442	4.921	N/A	19.050	9039930190500	●
7/8-9	H6/H7	0.755 - 0.778	5	0.697	0.523	5.512	N/A	22.225	9039930222250	●
1-8	H6/H7	0.865 - 0.890	5	0.800	0.600	6.299	N/A	25.400	9039930254000	●
1 1/8-7	H6/H7	1.035 - 1.053	5	0.896	0.672	7.087	N/A	28.575	9039930285750	●
1 1/4-7	H7/H8	1.095 - 1.123	5	1.021	0.766	7.087	N/A	31.750	9039930317500	●
1 3/8-6	H7/H8	1.285 - 1.303	5	1.108	0.831	7.874	N/A	34.925	9039930349250	●
1 1/2-6	H7/H8	1.320 - 1.350	6	1.233	0.925	7.874	N/A	38.100	9039930381000	●

UNF

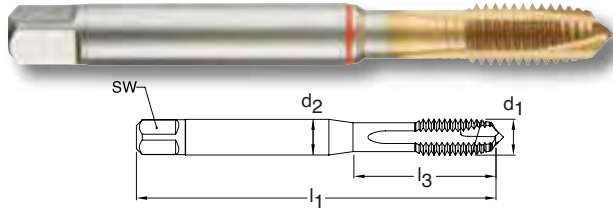

Series 3994
Standard DIN/ANSI
Tool Material HSS-E PM
Spiral Point Straight flute
Chamfer Form B • 3.5 - 5
Class of Fit 2B

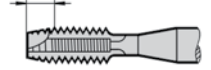

Through holes **S TiN coated** **External cooling**

d1 - P	H Limits	Tap Drill Range inch	Number of Flutes	d2 inch	SW inch	l1 inch	l3 inch	Order Code	EDP Number	Stock
4-48	H2/H3	0.089 - 0.097	3	0.141	0.110	2.205	0.709	2.845	9039940028450	●
5-44	H2/H3	0.100 - 0.108	3	0.141	0.110	2.205	0.709	3.175	9039940031750	●
6-40	H2/H3	0.111 - 0.119	3	0.141	0.110	2.205	0.748	3.505	9039940035050	●
8-36	H2/H3	0.134 - 0.142	3	0.168	0.131	2.480	0.827	4.166	9039940041660	●
10-32	H3/H4	0.156 - 0.164	3	0.194	0.152	2.756	0.945	4.826	9039940048260	●
12-28	H3/H4	0.177 - 0.186	3	0.220	0.165	3.150	1.024	5.486	9039940054860	●
1/4-28	H3/H4	0.211 - 0.220	3	0.255	0.191	3.150	1.181	6.350	9039940063500	●
5/16-24	H3/H4	0.267 - 0.277	3	0.318	0.238	3.543	1.377	7.938	9039940079380	●
3/8-24	H3/H4	0.330 - 0.340	3	0.381	0.286	3.543	1.456	9.525	9039940095250	●
7/16-20	H4/H5	0.383 - 0.395	3	0.323	0.242	3.937	N/A	11.113	9039940111130	●
1/2-20	H4/H5	0.446 - 0.457	4	0.367	0.275	3.937	N/A	12.700	9039940127000	●
9/16-18	H4/H5	0.472 - 0.490	4	0.429	0.322	3.937	N/A	14.288	9039940142880	●
5/8-18	H4/H5	0.565 - 0.578	4	0.480	0.360	3.937	N/A	15.875	9039940158750	●
3/4-16	H5/H6	0.682 - 0.696	4	0.590	0.442	4.331	N/A	19.050	9039940190500	●
7/8-14	H6/H7	0.798 - 0.813	4	0.697	0.523	4.921	N/A	22.225	9039940222250	●
1-12	H6/H7	0.910 - 0.928	4	0.800	0.600	5.512	N/A	25.400	9039940254000	●
1 1/8-12	H6/H7	0.970 - 0.998	4	0.896	0.672	5.906	N/A	28.575	9039940285750	●
1 1/4-12	H6/H7	1.160 - 1.178	4	1.021	0.766	5.906	N/A	31.750	9039940317500	●
1 3/8-12	H6/H7	1.195 - 1.225	6	1.108	0.831	6.693	N/A	34.925	9039940349250	●
1 1/2-12	H6/H7	1.410 - 1.428	6	1.233	0.925	6.693	N/A	38.100	9039940381000	●

UNF

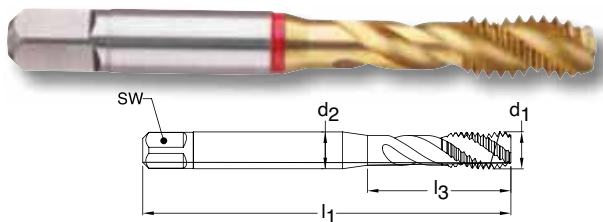

Series 3995
Standard DIN/ANSI
Tool Material HSS-E PM
Spiral Flute 40° Helix
Chamfer Form C • 2-3
Class of Fit 2B

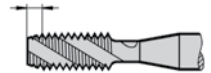

Blind holes **S TiN coated** **External cooling**

d1 - P	H Limits	Tap Drill Range inch	Number of Flutes	d2 inch	SW inch	l1 inch	l3 inch	Order Code	EDP Number	Stock
4-48	H2/H3	0.089 - 0.097	3	0.141	0.110	2.205	0.709	2.845	9039950028450	●
5-44	H2/H3	0.100 - 0.108	3	0.141	0.110	2.205	0.709	3.175	9039950031750	●
6-40	H2/H3	0.111 - 0.119	3	0.141	0.110	2.205	0.748	3.505	9039950035050	●
8-36	H2/H3	0.134 - 0.142	3	0.168	0.131	2.480	0.827	4.166	9039950041660	●
10-32	H3/H4	0.156 - 0.164	3	0.194	0.152	2.756	0.945	4.826	9039950048260	●
12-28	H3/H4	0.177 - 0.186	3	0.220	0.165	3.150	1.024	5.486	9039950054860	●
1/4-28	H3/H4	0.211 - 0.220	3	0.255	0.191	3.150	1.181	6.350	9039950063500	●
5/16-24	H3/H4	0.267 - 0.277	3	0.318	0.238	3.543	1.377	7.938	9039950079380	●
3/8-24	H3/H4	0.330 - 0.340	3	0.381	0.286	3.543	1.456	9.525	9039950095250	●
7/16-20	H4/H5	0.383 - 0.395	3	0.323	0.242	3.937	N/A	11.113	9039950111130	●
1/2-20	H4/H5	0.446 - 0.457	3	0.367	0.275	3.937	N/A	12.700	9039950127000	●
9/16-18	H4/H5	0.502 - 0.515	3	0.429	0.322	3.937	N/A	14.288	9039950142880	●
5/8-18	H4/H5	0.565 - 0.578	4	0.480	0.360	3.937	N/A	15.875	9039950158750	●
3/4-16	H5/H6	0.682 - 0.696	4	0.590	0.442	4.331	N/A	19.050	9039950190500	●
7/8-14	H6/H7	0.798 - 0.813	5	0.697	0.523	4.921	N/A	22.225	9039950222250	●
1-12	H6/H7	0.910 - 0.928	5	0.800	0.600	5.512	N/A	25.400	9039950254000	●
1 1/8-12	H6/H7	1.035 - 1.053	5	0.896	0.672	5.906	N/A	28.575	9039950285750	●
1 1/4-12	H6/H7	1.160 - 1.178	5	1.021	0.766	5.906	N/A	31.750	9039950317500	●
1 3/8-12	H6/H7	1.285 - 1.303	5	1.108	0.831	6.693	N/A	34.925	9039950349250	●
1 1/2-12	H6/H7	1.410 - 1.428	6	1.233	0.925	6.693	N/A	38.100	9039950381000	●

"Tap drill Range" given is per the Class of Fit shown per Series #
 Additional Tap Drill sizes & percent of thread engagement can be found on pages 229-237.

High-Tensile, Heat-Treatable Hardened and Tool Steels

UNC

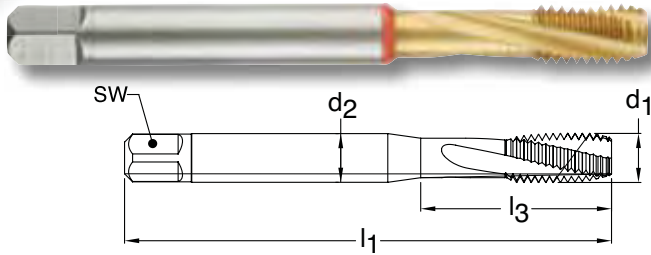

Series 4124
Standard DIN/ANSI
Tool Material HSS-E PM
Spiral Flute 15° Helix
Chamfer Form C • 2-3
Class of Fit 2B



Blind holes **TiN coated** **External cooling**

d1 - P	H Limits	Tap Drill Range inch	Number of Flutes	d2 inch	SW inch	l1 inch	l3 inch	Order Code	EDP Number	Stock
4-40	H2/H3	0.085 - 0.094	3	0.141	0.110	2.205	0.709	2.845	9041240028450	●
5-40	H2/H3	0.098 - 0.106	3	0.141	0.110	2.205	0.709	3.175	9041240031750	●
6-32	H3/H4	0.104 - 0.114	3	0.141	0.110	2.205	0.748	3.505	9041240035050	●
8-32	H3/H4	0.130 - 0.139	3	0.168	0.131	2.480	0.827	4.166	9041240041660	●
10-24	H3/H4	0.145 - 0.155	3	0.194	0.152	2.756	0.945	4.826	9041240048260	●
12-24	H3/H4	0.171 - 0.181	3	0.220	0.165	3.150	1.024	5.486	9041240054860	●
1/4-20	H4/H5	0.196 - 0.207	3	0.255	0.191	3.150	1.181	6.350	9041240063500	●
5/16-18	H4/H5	0.252 - 0.265	3	0.318	0.238	3.543	1.377	7.938	9041240079380	●
3/8-16	H5/H6	0.307 - 0.321	3	0.381	0.286	3.937	1.456	9.525	9041240095250	●
7/16-14	H5/H6	0.360 - 0.376	3	0.323	0.242	3.937	N/A	11.113	9041240111130	●
1/2-13	H5/H6	0.417 - 0.434	3	0.367	0.275	4.331	N/A	12.700	9041240127000	●
9/16-12	H5/H6	0.472 - 0.490	3	0.429	0.322	4.331	N/A	14.288	9041240142880	●
5/8-11	H5/H6	0.527 - 0.546	4	0.480	0.360	4.331	N/A	15.875	9041240158750	●
3/4-10	H5/H6	0.642 - 0.663	4	0.590	0.442	4.921	N/A	19.050	9041240190500	●
7/8-9	H6/H7	0.755 - 0.778	5	0.697	0.523	5.512	N/A	22.225	9041240222250	●
1-8	H6/H7	0.865 - 0.890	5	0.800	0.600	6.299	N/A	25.400	9041240254000	●

UNF

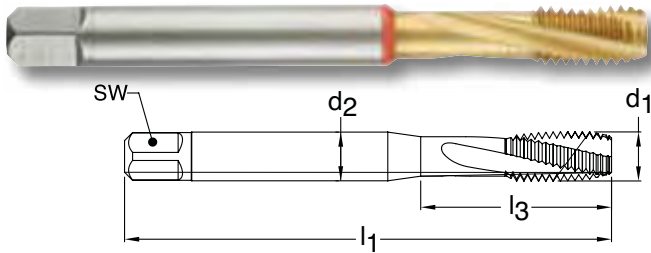

Series 4125
Standard DIN/ANSI
Tool Material HSS-E PM
Spiral Flute 15° Helix
Chamfer Form C • 2-3
Class of Fit 2B



Blind holes **TiN coated** **External cooling**

d1 - P	H Limits	Tap Drill Range inch	Number of Flutes	d2 inch	SW inch	l1 inch	l3 inch	Order Code	EDP Number	Stock
4-48	H2/H3	0.089 - 0.097	3	0.141	0.110	2.205	0.709	2.845	9041250028450	●
5-44	H2/H3	0.100 - 0.108	3	0.141	0.110	2.205	0.709	3.175	9041250031750	●
6-40	H2/H3	0.111 - 0.119	3	0.141	0.110	2.205	0.748	3.505	9041250035050	●
8-36	H2/H3	0.134 - 0.142	3	0.168	0.131	2.480	0.827	4.166	9041250041660	●
10-32	H3/H4	0.156 - 0.164	3	0.194	0.152	2.756	0.945	4.826	9041250048260	●
12-28	H3/H4	0.177 - 0.186	3	0.220	0.165	3.150	1.024	5.486	9041250054860	●
1/4-28	H3/H4	0.211 - 0.220	3	0.255	0.191	3.150	1.181	6.350	9041250063500	●
5/16-24	H3/H4	0.267 - 0.277	3	0.318	0.238	3.543	1.377	7.938	9041250079380	●
3/8-24	H3/H4	0.330 - 0.340	3	0.381	0.286	3.937	1.456	9.525	9041250095250	●
7/16-20	H4/H5	0.383 - 0.395	3	0.323	0.242	3.937	N/A	11.113	9041250111130	●
1/2-20	H4/H5	0.446 - 0.457	3	0.367	0.275	4.331	N/A	12.700	9041250127000	●
9/16-18	H4/H5	0.502 - 0.515	3	0.429	0.322	4.331	N/A	14.288	9041250142880	●
5/8-18	H4/H5	0.565 - 0.578	4	0.480	0.360	4.331	N/A	15.875	9041250158750	●
3/4-16	H5/H6	0.682 - 0.696	4	0.590	0.442	4.331	N/A	19.050	9041250190500	●
7/8-14	H6/H7	0.798 - 0.813	5	0.697	0.523	4.921	N/A	22.225	9041250222250	●
1-12	H6/H7	0.910 - 0.928	5	0.800	0.600	5.512	N/A	25.400	9041250254000	●

UNC Slow helix PM taps

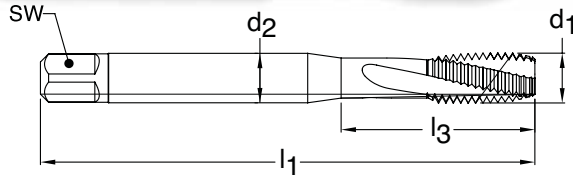

Blind holes



TiCN coated



Axial coolant

Series 4388
Standard DIN/ANSI
Tool Material HSS-E-PM
Spiral Flute 15° Helix
Chamfer Form C • 2-3
Class of Fit 2BX

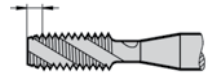

d1 - P	H Limits	Tap Drill Range inch	Number of Flutes	d2 inch	SW inch	l1 inch	l3 inch	Order Code	EDP Number	Stock
10-24	H4/H5	0.145 - 0.155	3	0.194	0.152	2.756	0.945	4.826	9043880048260	●
1/4-20	H5/H6	0.196 - 0.207	3	0.255	0.191	3.150	1.181	6.350	9043880063500	●
5/16-18	H5/H6	0.252 - 0.265	3	0.318	0.238	3.543	1.377	7.938	9043880079380	●
3/8-16	H6/H7	0.307 - 0.321	3	0.381	0.286	3.937	1.456	9.525	9043880095250	●
7/16-14	H6/H7	0.360 - 0.376	4	0.323	0.242	3.937	N/A	11.113	9043880111130	●
1/2-13	H6/H7	0.417 - 0.434	4	0.367	0.275	4.331	N/A	12.700	9043880127000	●
5/8-11	H6/H7	0.527 - 0.546	4	0.480	0.360	4.331	N/A	15.875	9043880158750	●
3/4-10	H6/H7	0.642 - 0.663	4	0.590	0.442	4.921	N/A	19.050	9043880190500	●
7/8-9	H7/H8	0.755 - 0.778	4	0.697	0.523	5.512	N/A	22.225	9043880222250	●
1-8	H7/H8	0.865 - 0.890	4	0.800	0.600	6.299	N/A	25.400	9043880254000	●

UNF Slow helix PM taps

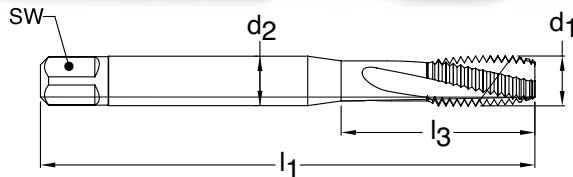

Blind holes



TiCN coated



Axial coolant

Series 4389
Standard DIN/ANSI
Tool Material HSS-E-PM
Spiral Flute 15° Helix
Chamfer Form C • 2-3
Class of Fit 2BX

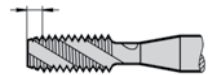

d1 - P	H Limits	Tap Drill Range inch	Number of Flutes	d2 inch	SW inch	l1 inch	l3 inch	Order Code	EDP Number	Stock
10-32	H4/H5	0.156 - 0.164	3	0.194	0.152	2.756	0.945	4.826	9043890048260	●
1/4-28	H4/H5	0.211 - 0.220	3	0.255	0.191	3.150	1.181	6.350	9043890063500	●
5/16-24	H4/H5	0.267 - 0.277	3	0.318	0.238	3.543	1.377	7.938	9043890079380	●
3/8-24	H4/H5	0.330 - 0.340	4	0.381	0.286	3.543	1.456	9.525	9043890095250	●
7/16-20	H5/H6	0.383 - 0.395	4	0.323	0.242	3.937	N/A	11.113	9043890111130	●
1/2-20	H5/H6	0.446 - 0.457	4	0.367	0.275	3.937	N/A	12.700	9043890127000	●
5/8-18	H5/H6	0.565 - 0.578	5	0.480	0.360	3.937	N/A	15.875	9043890158750	●
3/4-16	H6/H7	0.682 - 0.696	5	0.590	0.442	4.331	N/A	19.050	9043890190500	●
7/8-14	H7/H8	0.798 - 0.813	6	0.697	0.523	4.921	N/A	22.225	9043890222250	●
1-12	H7/H8	0.910 - 0.928	6	0.800	0.600	5.512	N/A	25.400	9043890254000	●

High-Tensile, Heat-Treatable Hardened and Tool Steels

UNC Slow helix PM taps

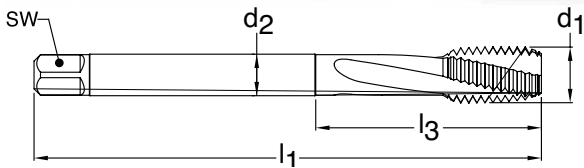

Blind holes



TiCN coated



External cooling

Chamfer Form E • 1.5 - 2

Class of Fit

2BX

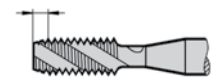

Series **4373**

Standard **DIN/ANSI**

Tool Material **HSS-E-PM**

Spiral Flute **15° Helix**

d1 - P	H Limits	Tap Drill Range inch	Number of Flutes	d2 inch	SW inch	l1 inch	l3 inch	Order Code	EDP Number	Stock
2-56	H3/H4	0.067 - 0.074	3	0.141	0.110	1.772	0.441	2.184	9043730021840	●
4-40	H3/H4	0.085 - 0.094	3	0.141	0.110	2.205	0.709	2.845	9043730028450	●
5-40	H3/H4	0.098 - 0.106	3	0.141	0.110	2.205	0.709	3.175	9043730031750	●
6-32	H4/H5	0.104 - 0.114	3	0.141	0.110	2.205	0.709	3.505	9043730035050	●
8-32	H4/H5	0.130 - 0.139	3	0.168	0.131	2.480	0.827	4.166	9043730041660	●

UNC Slow helix PM taps

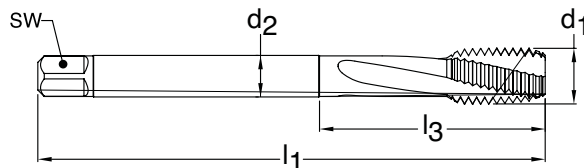

Blind holes



TiCN coated



Axial coolant

Chamfer Form E • 1.5 - 2

Class of Fit

2BX

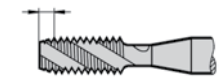

Series **4375**

Standard **DIN/ANSI**

Tool Material **HSS-E-PM**

Spiral Flute **15° Helix**

d1 - P	H Limits	Tap Drill Range inch	Number of Flutes	d2 inch	SW inch	l1 inch	l3 inch	Order Code	EDP Number	Stock
10-24	H4/H5	0.145 - 0.155	3	0.194	0.152	2.756	0.945	4.826	9043750048260	●
12-24	H4/H5	0.171 - 0.181	3	0.220	0.165	3.150	1.024	5.486	9043750054860	●
1/4-20	H5/H6	0.196 - 0.207	3	0.255	0.191	3.150	1.181	6.350	9043750063500	●
5/16-18	H5/H6	0.252 - 0.265	3	0.318	0.238	3.543	1.377	7.938	9043750079380	●
3/8-16	H6/H7	0.307 - 0.321	3	0.381	0.286	3.937	1.456	9.525	9043750095250	●
7/16-14	H6/H7	0.360 - 0.376	4	0.323	0.242	3.937	N/A	11.113	9043750111130	●
1/2-13	H6/H7	0.417 - 0.434	4	0.367	0.275	4.331	N/A	12.700	9043750127000	●
9/16-12	H6/H7	0.472 - 0.490	4	0.429	0.322	4.331	N/A	14.288	9043750142880	●
5/8-11	H6/H7	0.527 - 0.546	4	0.480	0.360	4.331	N/A	15.875	9043750158750	●
3/4-10	H6/H7	0.642 - 0.663	4	0.590	0.442	4.921	N/A	19.050	9043750190500	●
7/8-9	H7/H8	0.755 - 0.778	4	0.697	0.523	5.512	N/A	22.225	9043750222250	●
1-8	H7/H8	0.865 - 0.890	4	0.800	0.600	6.299	N/A	25.400	9043750254000	●

UNF Slow helix PM taps

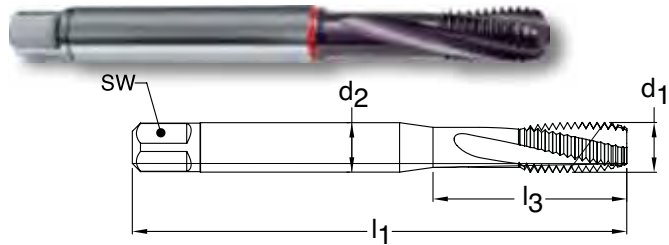

Series 4374
Standard DIN/ANSI
Tool Material HSS-E-PM
Spiral Flute 15° Helix

Chamfer Form E • 1.5 - 2

Class of Fit 2BX



Blind holes



TiCN coated



External cooling

d1 - P	H Limits	Tap Drill Range inch	Number of Flutes	d2 inch	SW inch	l1 inch	l3 inch	Order Code	EDP Number	Stock
2-64	H3/H4	0.069 - 0.075	3	0.141	0.110	1.772	0.441	2.184	9043740021840	●
4-48	H3/H4	0.089 - 0.097	3	0.141	0.110	2.205	0.709	2.845	9043740028450	●
5-44	H3/H4	0.100 - 0.108	3	0.141	0.110	2.205	0.709	3.175	9043740031750	●
6-40	H3/H4	0.111 - 0.119	3	0.141	0.110	2.205	0.709	3.505	9043740035050	●
8-36	H3/H4	0.134 - 0.142	3	0.168	0.131	2.480	0.827	4.166	9043740041660	●

UNF Slow helix PM taps

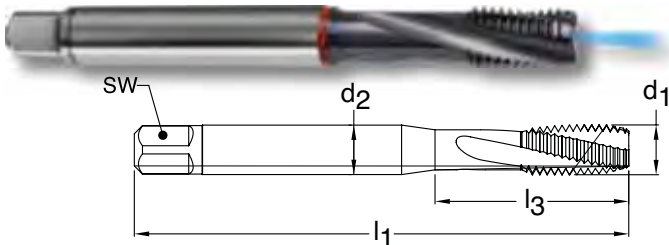

Series 4376
Standard DIN/ANSI
Tool Material HSS-E-PM
Spiral Flute 15° Helix

Chamfer Form E • 1.5 - 2

Class of Fit 2BX



Blind holes



TiCN coated



Axial coolant

d1 - P	H Limits	Tap Drill Range inch	Number of Flutes	d2 inch	SW inch	l1 inch	l3 inch	Order Code	EDP Number	Stock
10-32	H4/H5	0.156 - 0.164	3	0.194	0.152	2.756	0.945	4.826	9043760048260	●
12-28	H4/H5	0.177 - 0.186	3	0.220	0.165	3.150	1.024	5.486	9043760054860	●
1/4-28	H4/H5	0.211 - 0.220	3	0.255	0.191	3.150	1.181	6.350	9043760063500	●
5/16-24	H4/H5	0.267 - 0.277	3	0.318	0.238	3.543	1.377	7.938	9043760079380	●
3/8-24	H4/H5	0.330 - 0.340	4	0.381	0.286	3.543	1.456	9.525	9043760095250	●
7/16-20	H5/H6	0.383 - 0.395	4	0.323	0.242	3.937	N/A	11.113	9043760111130	●
1/2-20	H5/H6	0.446 - 0.457	4	0.367	0.275	3.937	N/A	12.700	9043760127000	●
9/16-18	H5/H6	0.502 - 0.515	4	0.429	0.322	3.937	N/A	14.288	9043760142880	●
5/8-18	H5/H6	0.565 - 0.578	5	0.480	0.360	3.937	N/A	15.875	9043760158750	●
3/4-16	H6/H7	0.682 - 0.696	5	0.590	0.442	4.331	N/A	19.050	9043760190500	●
7/8-14	H7/H8	0.798 - 0.813	6	0.697	0.523	4.921	N/A	22.225	9043760222250	●
1-12	H7/H8	0.910 - 0.928	6	0.800	0.600	5.512	N/A	25.400	9043760254000	●

"Tap drill Range" given is per the Class of Fit shown per Series #
 Additional Tap Drill sizes & percent of thread engagement can be found on pages 229-237.

UNC Straight flute PM taps

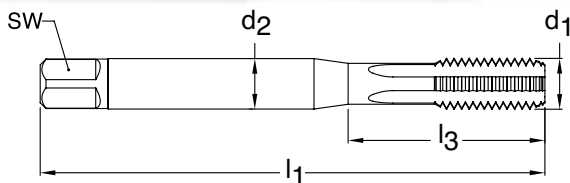

Blind holes



TiCN coated



Axial coolant

Series 4394
Standard DIN/ANSI
Tool Material HSS-E-PM
Flute Straight Flute
Chamfer Form C • 2-3
Class of Fit 2BX

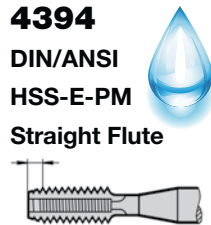

d1 - P	D Limits	Tap Drill Range in	Number of Flutes	d2 inch	SW inch	l1 inch	l3 inch	Order Code	EDP Number	Stock
10-24	H4/H5	0.145 - 0.155	3	0.194	0.152	2.756	0.945	4.826	9043940048260	●
1/4-20	H5/H6	0.196 - 0.207	3	0.255	0.191	3.150	1.181	6.350	9043940063500	●
5/16-18	H5/H6	0.252 - 0.265	3	0.318	0.238	3.543	1.377	7.938	9043940079380	●
3/8-16	H6/H7	0.307 - 0.321	3	0.381	0.286	3.937	1.456	9.525	9043940095250	●
1/2-13	H6/H7	0.417 - 0.434	3	0.367	0.275	4.331	N/A	12.700	9043940127000	●
5/8-11	H6/H7	0.527 - 0.546	4	0.480	0.360	4.331	N/A	15.875	9043940158750	●
3/4-10	H6/H7	0.642 - 0.663	4	0.590	0.442	4.921	N/A	19.050	9043940190500	●
7/8-9	H7/H8	0.755 - 0.778	5	0.697	0.523	5.512	N/A	22.225	9043940222250	●
1-8	H7/H8	0.865 - 0.890	5	0.800	0.600	6.299	N/A	25.400	9043940254000	●

UNF Straight flute PM taps

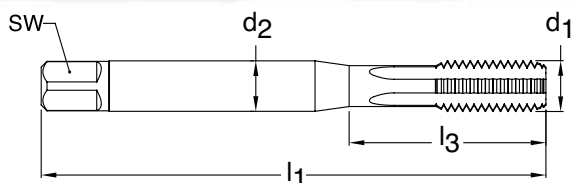

Blind holes



TiCN coated



Axial coolant

Series 4391
Standard DIN/ANSI
Tool Material HSS-E-PM
Flute Straight Flute
Chamfer Form C • 2-3
Class of Fit 2BX

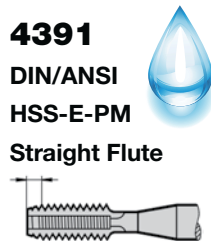

d1 - P	D Limits	Tap Drill Range mm	Number of Flutes	d2 inch	SW inch	l1 inch	l3 inch	Order Code	EDP Number	Stock
10-32	H4/H5	0.156 - 0.164	3	0.194	0.152	2.756	0.945	4.826	9043910048260	●
1/4-28	H4/H5	0.211 - 0.220	3	0.255	0.191	3.150	1.181	6.350	9043910063500	●
5/16-24	H4/H5	0.267 - 0.277	3	0.318	0.238	3.543	1.377	7.938	9043910079380	●
3/8-24	H4/H5	0.330 - 0.340	3	0.381	0.286	3.543	1.456	9.525	9043910095250	●
1/2-20	H5/H6	0.446 - 0.457	3	0.367	0.275	3.937	N/A	12.700	9043910127000	●
5/8-18	H5/H6	0.565 - 0.578	4	0.480	0.360	3.937	N/A	15.875	9043910158750	●
3/4-16	H6/H7	0.682 - 0.696	4	0.590	0.442	4.331	N/A	19.050	9043910190500	●
7/8-14	H7/H8	0.798 - 0.813	5	0.697	0.523	4.921	N/A	22.225	9043910222250	●
1-12	H7/H8	0.910 - 0.928	5	0.800	0.600	5.512	N/A	25.400	9043910254000	●

METRIC

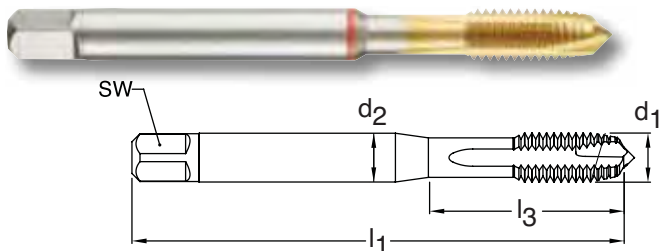

Series 4122
Standard DIN/ANSI
Tool Material HSS-E PM
Spiral Point Straight flute
Chamfer Form B • 3.5 - 5
Class of Fit ISO 2(6H)

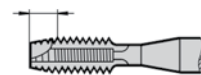

Through holes **TiN coated** **External cooling**

d1 - P	D Limits	Tap Drill Range mm	Number of Flutes	d2 inch	SW inch	l1 inch	l3 inch	Order Code	EDP Number	Stock
M3 X 0.50	D2/D3	2.459 - 2.599	3	0.141	0.110	2.205	0.709	3.000	9041220030000	●
M4 X 0.70	D3/D4	3.242 - 3.422	3	0.168	0.131	2.480	0.827	4.000	9041220040000	●
M5 X 0.80	D3/D4	4.134 - 4.334	3	0.194	0.152	2.756	0.945	5.000	9041220050000	●
M6 X 1.00	D4/D5	4.917 - 5.153	3	0.255	0.191	3.150	1.181	6.000	9041220060000	●
M8 X 1.25	D4/D5	6.647 - 6.912	3	0.318	0.238	3.543	1.377	8.000	9041220080000	●
M10 X 1.50	D4/D5	8.376 - 8.676	3	0.381	0.286	3.937	1.456	10.000	9041220100000	●
M12 X 1.75	D5/D6	10.106 - 10.441	4	0.367	0.275	4.331	N/A	12.000	9041220120000	●
M14 X 2.00	D5/D6	11.835 - 12.210	4	0.429	0.322	4.331	N/A	14.000	9041220140000	●
M16 X 2.00	D6/D7	13.835 - 14.210	4	0.480	0.360	4.331	N/A	16.000	9041220160000	●
M18 X 2.50	D6/D7	15.294 - 15.744	4	0.542	0.406	4.921	N/A	18.000	9041220180000	●
M20 X 2.50	D6/D7	17.294 - 17.744	4	0.652	0.489	5.512	N/A	20.000	9041220200000	●

METRIC

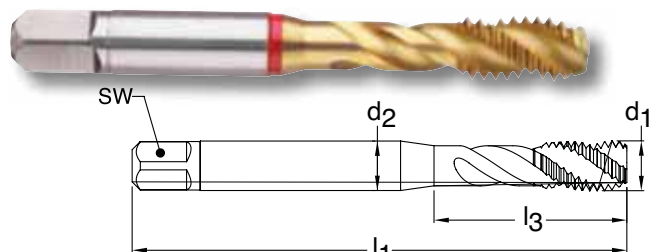

Series 4120
Standard DIN/ANSI
Tool Material HSS-E PM
Spiral Flute 40° Helix
Chamfer Form C • 2-3
Class of Fit ISO 2(6H)



Blind holes **TiN coated** **External cooling**

d1 - P	D Limits	Tap Drill Range mm	Number of Flutes	d2 inch	SW inch	l1 inch	l3 inch	Order Code	EDP Number	Stock
M3 X 0.50	D2/D3	2.459 - 2.599	3	0.141	0.110	2.205	0.709	3.000	9041200030000	●
M4 X 0.70	D3/D4	3.242 - 3.422	3	0.168	0.131	2.480	0.827	4.000	9041200040000	●
M5 X 0.80	D3/D4	4.134 - 4.334	3	0.194	0.152	2.756	0.945	5.000	9041200050000	●
M6 X 1.00	D4/D5	4.917 - 5.153	3	0.255	0.191	3.150	1.181	6.000	9041200060000	●
M8 X 1.25	D4/D5	6.647 - 6.912	3	0.318	0.238	3.543	1.377	8.000	9041200080000	●
M10 X 1.50	D4/D5	8.376 - 8.676	3	0.381	0.286	3.937	1.456	10.000	9041200100000	●
M12 X 1.75	D5/D6	10.106 - 10.441	3	0.367	0.275	4.331	N/A	12.000	9041200120000	●
M14 X 2.00	D5/D6	11.835 - 12.210	3	0.429	0.322	4.331	N/A	14.000	9041200140000	●
M16 X 2.00	D6/D7	13.835 - 14.210	4	0.480	0.360	4.331	N/A	16.000	9041200160000	●
M18 X 2.50	D6/D7	15.294 - 15.744	4	0.542	0.406	4.921	N/A	18.000	9041200180000	●
M20 X 2.50	D6/D7	17.294 - 17.744	4	0.652	0.489	5.512	N/A	20.000	9041200200000	●

"Tap drill Range" given is per the Class of Fit shown per Series #
 Additional Tap Drill sizes & percent of thread engagement can be found on pages 229-237.

METRIC FINE

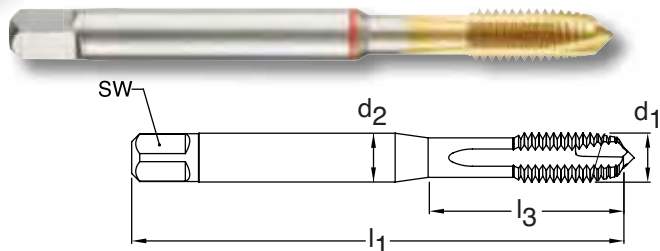

Through holes



TiN coated



External cooling

Series 4123
Standard DIN/ANSI
Tool Material HSS-E PM
Spiral Point Straight flute
Chamfer Form B • 3.5 - 5
Class of Fit ISO 2(6H)

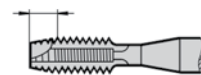

d1 - P	D Limits	Tap Drill Range mm	Number of Flutes	d2 inch	SW inch	l1 inch	l3 inch	Order Code	EDP Number	Stock
M8 X 1.00	D4/D5	6.917 - 7.153	3	0.318	0.238	3.543	1.377	8.005	9041230080050	●
M10 X 1.00	D4/D5	8.917 - 9.153	3	0.381	0.286	3.543	1.377	10.005	9041230100050	●
M10 X 1.25	D4/D5	8.647 - 8.912	3	0.381	0.286	3.543	1.456	10.006	9041230100060	●
M12 X 1.00	D4/D5	10.917 - 11.153	4	0.367	0.275	3.937	N/A	12.005	9041230120050	●
M12 X 1.25	D4/D5	10.647 - 10.912	4	0.367	0.275	3.937	N/A	12.006	9041230120060	●
M12 X 1.50	D5/D6	10.376 - 10.676	4	0.367	0.275	3.937	N/A	12.007	9041230120070	●
M14 X 1.25	D4/D5	12.647 - 12.912	4	0.429	0.322	3.937	N/A	14.006	9041230140060	●
M14 X 1.50	D4/D5	12.376 - 12.676	4	0.429	0.322	3.937	N/A	14.007	9041230140070	●
M16 X 1.50	D4/D5	14.376 - 14.676	4	0.480	0.360	3.937	N/A	16.007	9041230160070	●
M18 X 1.50	D4/D5	16.376 - 16.676	4	0.542	0.406	4.331	N/A	18.007	9041230180070	●
M20 X 1.50	D6/D7	18.376 - 18.676	4	0.652	0.489	4.921	N/A	20.007	9041230200070	●

METRIC FINE

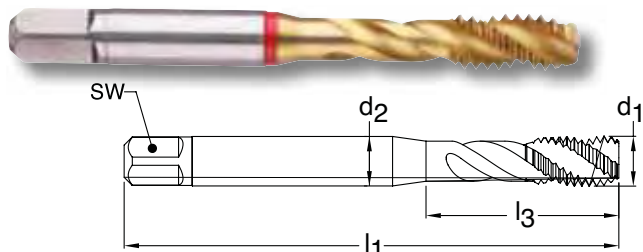

Blind holes



TiN coated



External cooling

Series 4121
Standard DIN/ANSI
Tool Material HSS-E PM
Spiral Flute 40° Helix
Chamfer Form C • 2-3
Class of Fit ISO 2(6H)



d1 - P	D Limits	Tap Drill Range mm	Number of Flutes	d2 inch	SW inch	l1 inch	l3 inch	Order Code	EDP Number	Stock
M8 X 1.00	D4/D5	6.917 - 7.153	3	0.318	0.238	3.543	1.377	8.005	9041210080050	●
M10 X 1.00	D4/D5	8.917 - 9.153	3	0.381	0.286	3.543	1.377	10.005	9041210100050	●
M10 X 1.25	D4/D5	8.647 - 8.912	3	0.381	0.286	3.937	1.456	10.006	9041210100060	●
M12 X 1.00	D4/D5	10.917 - 11.153	3	0.367	0.275	3.937	N/A	12.005	9041210120050	●
M12 X 1.25	D4/D5	10.647 - 10.912	3	0.367	0.275	3.937	N/A	12.006	9041210120060	●
M12 X 1.50	D5/D6	10.376 - 10.676	3	0.367	0.275	3.937	N/A	12.007	9041210120070	●
M14 X 1.25	D4/D5	12.647 - 12.912	3	0.429	0.322	3.937	N/A	14.006	9041210140060	●
M14 X 1.50	D4/D5	12.376 - 12.676	3	0.429	0.322	3.937	N/A	14.007	9041210140070	●
M16 X 1.50	D4/D5	14.376 - 14.676	4	0.480	0.360	3.937	N/A	16.007	9041210160070	●
M18 X 1.50	D4/D5	16.376 - 16.676	4	0.542	0.406	3.937	N/A	18.007	9041210180070	●
M20 X 1.50	D6/D7	18.376 - 18.676	4	0.652	0.489	4.921	N/A	20.007	9041210200070	●

METRIC

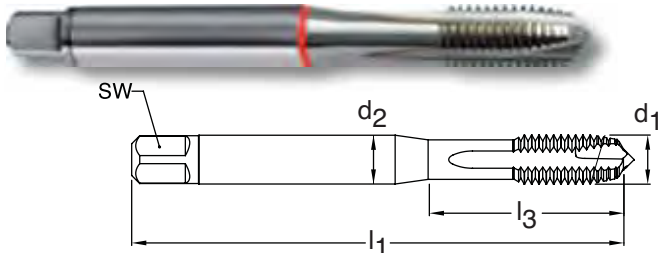

Series 804
Standard DIN 371
Tool Material HSS-E (Cobalt)
Spiral Point Straight flute
Chamfer Form B • 3.5 - 5
Class of Fit 6H



Through holes **bright finish** **External cooling**

d1 - P	D Limits	Tap Drill Range mm	Number of Flutes	d2 mm	SW mm	l1 mm	l3 mm	Order Code	EDP Number	Stock
M2 X 0.40	D2/D3	1.567 - 1.679	3	2.80	2.10	45.00	13.50	2.000	9008040020000	●
M2.2 X 0.45	D2/D3	1.713 - 1.838	3	2.80	2.10	45.00	14.50	2.200	9008040022000	○
M2.3 X 0.40	D2/D3	1.870 - 1.980	3	2.80	2.10	45.00	14.50	2.300	9008040023000	○
M2.5 X 0.45	D2/D3	2.013 - 2.138	3	2.80	2.10	50.00	14.50	2.500	9008040025000	●
M2.6 X 0.45	D2/D3	2.110 - 2.240	3	2.80	2.10	50.00	14.50	2.600	9008040026000	○
M3 X 0.50	D2/D3	2.459 - 2.599	3	3.50	2.70	56.00	18.00	3.000	9008040030000	○
M3.5 X 0.60	D3/D4	2.850 - 3.010	3	4.00	3.00	56.00	20.00	3.500	9008040035000	●
M4 X 0.70	D3/D4	3.242 - 3.422	3	4.50	3.40	63.00	21.00	4.000	9008040040000	●
M5 X 0.80	D3/D4	4.134 - 4.334	3	6.00	4.90	70.00	25.00	5.000	9008040050000	●
M6 X 1.00	D4/D5	4.917 - 5.153	3	6.00	4.90	80.00	30.00	6.000	9008040060000	●
M8 X 1.25	D4/D5	6.647 - 6.912	3	8.00	6.20	90.00	35.00	8.000	9008040080000	●
M10 X 1.50	D4/D5	8.376 - 8.676	3	10.00	8.00	100.00	39.00	10.000	9008040100000	●

METRIC

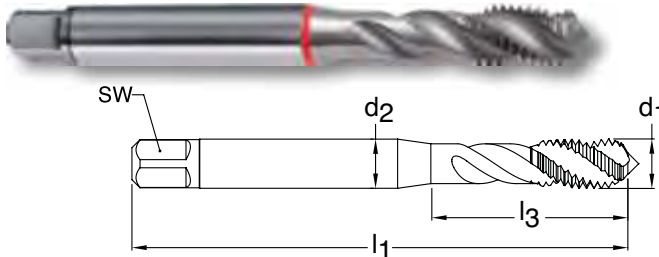

Series 811
Standard DIN 371
Tool Material HSS-E (Cobalt)
Spiral Flute 40° Helix
Chamfer Form C • 2-3
Class of Fit ISO 2(6H)

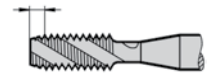

Blind holes **bright finish** **External cooling**

d1 - P	D Limits	Tap Drill Range mm	Number of Flutes	d2 mm	SW mm	l1 mm	l3 mm	Order Code	EDP Number	Stock
M2 X 0.40	D2/D3	1.567 - 1.679	3	2.80	2.10	45.00	13.50	2.000	9008110020000	●
M2.5 X 0.45	D2/D3	2.013 - 2.138	3	2.80	2.10	50.00	14.50	2.500	9008110025000	●
M2.6 X 0.45	D2/D3	2.110 - 2.240	3	2.80	2.10	50.00	14.50	2.600	9008110026000	○
M3 X 0.50	D2/D3	2.459 - 2.599	3	3.50	2.70	56.00	18.00	3.000	9008110030000	○
M3.5 X 0.60	D3/D4	2.850 - 3.010	3	4.00	3.00	56.00	20.00	3.500	9008110035000	○
M4 X 0.70	D3/D4	3.242 - 3.422	3	4.50	3.40	63.00	21.00	4.000	9008110040000	○
M5 X 0.80	D3/D4	4.134 - 4.334	3	6.00	4.90	70.00	25.00	5.000	9008110050000	●
M6 X 1.00	D4/D5	4.917 - 5.153	3	6.00	4.90	80.00	30.00	6.000	9008110060000	○
M7 X 1.00	D4/D5	5.917 - 6.153	3	7.00	5.50	80.00	30.00	7.000	9008110070000	○
M8 X 1.25	D4/D5	6.647 - 6.912	3	8.00	6.20	90.00	35.00	8.000	9008110080000	●
M10 X 1.50	D4/D5	8.376 - 8.676	3	10.00	8.00	100.00	39.00	10.000	9008110100000	●

"Tap drill Range" given is per the Class of Fit shown per Series #
 Additional Tap Drill sizes & percent of thread engagement can be found on pages 229-237.

METRIC

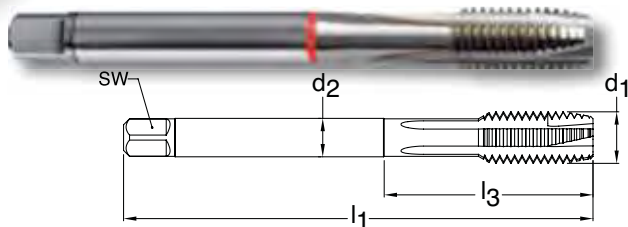

Series 816
Standard DIN 376
Tool Material HSS-E (Cobalt)
Spiral Point Straight flute
Chamfer Form B • 3.5 - 5
Class of Fit ISO 2(6H)

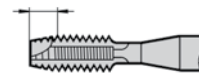

Through holes **bright finish** **External cooling**

d1 - P	D Limits	Tap Drill Range mm	Number of Flutes	d2 mm	SW mm	l1 mm	l3 mm	Order Code	EDP Number	Stock
M3 X 0.50	D2/D3	2.459 - 2.599	3	2.20	N/A	56.00	N/A	3.000	9008160030000	○
M4 X 0.70	D3/D4	3.242 - 3.422	3	2.80	2.10	63.00	N/A	4.000	9008160040000	○
M5 X 0.80	D3/D4	4.134 - 4.334	3	3.50	2.70	70.00	N/A	5.000	9008160050000	○
M6 X 1.00	D4/D5	4.917 - 5.153	3	4.50	3.40	80.00	N/A	6.000	9008160060000	●
M8 X 1.25	D4/D5	6.647 - 6.912	3	6.00	4.90	90.00	N/A	8.000	9008160080000	○
M10 X 1.50	D4/D5	8.376 - 8.676	3	7.00	5.50	100.00	N/A	10.000	9008160100000	●
M12 X 1.75	D5/D6	10.106 - 10.441	4	9.00	7.00	110.00	N/A	12.000	9008160120000	○
M14 X 2.00	D5/D6	11.835 - 12.210	4	11.00	9.00	110.00	N/A	14.000	9008160140000	●
M16 X 2.00	D6/D7	13.835 - 14.210	4	12.00	9.00	110.00	N/A	16.000	9008160160000	●
M18 X 2.50	D6/D7	15.294 - 15.744	4	14.00	11.00	125.00	N/A	18.000	9008160180000	○
M20 X 2.50	D6/D7	17.294 - 17.744	4	16.00	12.00	140.00	N/A	20.000	9008160200000	●
M24 X 3.00	D7/D8	20.752 - 21.252	4	18.00	14.50	160.00	N/A	24.000	9008160240000	●

METRIC

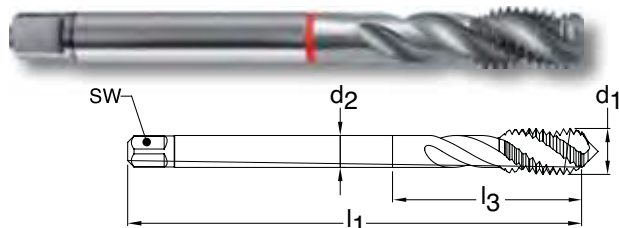

Series 823
Standard DIN 376
Tool Material HSS-E (Cobalt)
Spiral Flute 40° Helix
Chamfer Form C • 2-3
Class of Fit ISO 2(6H)



Blind holes **bright finish** **External cooling**

d1 - P	D Limits	Tap Drill Range mm	Number of Flutes	d2 mm	SW mm	l1 mm	l3 mm	Order Code	EDP Number	Stock
M3 X 0.50	D2/D3	2.459 - 2.599	3	2.20	N/A	56.00	N/A	3.000	9008230030000	●
M4 X 0.70	D3/D4	3.242 - 3.422	3	2.80	2.10	63.00	N/A	4.000	9008230040000	●
M5 X 0.80	D3/D4	4.134 - 4.334	3	3.50	2.70	70.00	N/A	5.000	9008230050000	●
M6 X 1.00	D4/D5	4.917 - 5.153	3	4.50	3.40	80.00	N/A	6.000	9008230060000	●
M8 X 1.25	D4/D5	6.647 - 6.912	3	6.00	4.90	90.00	N/A	8.000	9008230080000	●
M10 X 1.50	D4/D5	8.376 - 8.676	3	7.00	5.50	100.00	N/A	10.000	9008230100000	●
M12 X 1.75	D5/D6	10.106 - 10.441	3	9.00	7.00	110.00	N/A	12.000	9008230120000	●
M14 X 2.00	D5/D6	11.835 - 12.210	3	11.00	9.00	110.00	N/A	14.000	9008230140000	●
M16 X 2.00	D6/D7	13.835 - 14.210	4	12.00	9.00	110.00	N/A	16.000	9008230160000	●
M18 X 2.50	D6/D7	15.294 - 15.744	4	14.00	11.00	125.00	N/A	18.000	9008230180000	○
M20 X 2.50	D6/D7	17.294 - 17.744	4	16.00	12.00	140.00	N/A	20.000	9008230200000	○
M22 X 2.50	D6/D7	19.294 - 19.744	5	18.00	14.50	140.00	N/A	22.000	9008230220000	○
M24 X 3.00	D7/D8	20.752 - 21.252	5	18.00	14.50	160.00	N/A	24.000	9008230240000	●
M30 X 3.50	D7/D8	26.211 - 26.771	5	22.00	18.00	180.00	N/A	30.000	9008230300000	●

METRIC FINE

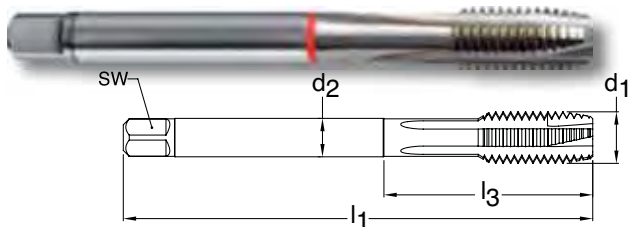

Series 828
Standard DIN 374
Tool Material HSS-E (Cobalt)
Spiral Point Straight flute
Chamfer Form B • 3.5 - 5

Class of Fit ISO 2(GH)
 External cooling

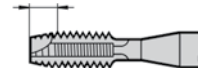

Through holes **bright finish**

d1 - P	D Limits	Tap Drill Range mm	Number of Flutes	d2 mm	SW mm	l1 mm	l3 mm	Order Code	EDP Number	Stock
M3 X 0.35	D2/D3	2.621 - 2.721	3	2.20	N/A	56.00	N/A	3.002	9008280030020	○
M4 X 0.50	D3/D4	3.459 - 3.599	3	2.80	2.10	63.00	N/A	4.003	9008280040030	○
M5 X 0.50	D3/D4	4.459 - 4.599	3	3.50	2.70	70.00	N/A	5.003	9008280050030	○
M6 X 0.50	D3/D4	5.460 - 5.600	3	4.50	3.40	80.00	N/A	6.003	9008280060030	○
M6 X 0.75	D3/D4	5.188 - 5.378	3	4.50	3.40	80.00	N/A	6.004	9008280060040	●
M8 X 0.75	D3/D4	7.188 - 7.378	3	6.00	4.90	80.00	N/A	8.004	9008280080040	○
M8 X 1.00	D4/D5	6.917 - 7.153	3	6.00	4.90	90.00	N/A	8.005	9008280080050	○
M10 X 1.00	D4/D5	8.917 - 9.153	3	7.00	5.50	90.00	N/A	10.005	9008280100050	○
M12 X 1.00	D4/D5	10.917 - 11.153	4	9.00	7.00	100.00	N/A	12.005	9008280120050	○
M12 X 1.50	D4/D5	10.376 - 10.676	4	9.00	7.00	100.00	N/A	12.007	9008280120070	●
M14 X 1.50	D4/D5	12.376 - 12.676	4	11.00	9.00	100.00	N/A	14.007	9008280140070	○
M16 X 1.50	D4/D5	14.376 - 14.676	4	12.00	9.00	100.00	N/A	16.007	9008280160070	○
M18 X 1.50	D4/D5	16.376 - 16.676	4	14.00	11.00	110.00	N/A	18.007	9008280180070	○
M20 X 1.50	D6/D7	18.376 - 18.676	4	16.00	12.00	125.00	N/A	20.007	9008280200070	●
M22 X 1.50	D6/D7	20.376 - 20.676	4	18.00	14.50	125.00	N/A	22.007	9008280220070	○

METRIC FINE

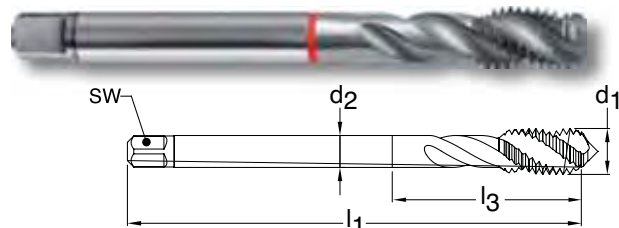

Series 835
Standard DIN 374
Tool Material HSS-E (Cobalt)
Spiral Flute 40° Helix
Chamfer Form C • 2-3

Class of Fit ISO 2(6H)
 External cooling

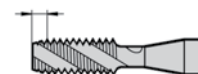

Blind holes **bright finish** **External cooling**

d1 - P	D Limits	Tap Drill Range mm	Number of Flutes	d2 mm	SW mm	l1 mm	l3 mm	Order Code	EDP Number	Stock
M8 X 0.75	D3/D4	7.188 - 7.378	3	6.00	4.90	80.00	N/A	8.004	9008350080040	○
M8 X 1.00	D4/D5	6.917 - 7.153	3	6.00	4.90	90.00	N/A	8.005	9008350080050	●
M10 X 1.00	D4/D5	8.917 - 9.153	3	7.00	5.50	90.00	N/A	10.005	9008350100050	●
M12 X 1.50	D4/D5	10.376 - 10.676	3	9.00	7.00	100.00	N/A	12.007	9008350120070	●
M14 X 1.50	D4/D5	12.376 - 12.676	3	11.00	9.00	100.00	N/A	14.007	9008350140070	●
M16 X 1.50	D4/D5	14.376 - 14.676	4	12.00	9.00	100.00	N/A	16.007	9008350160070	○
M18 X 1.50	D4/D5	16.376 - 16.676	4	14.00	11.00	110.00	N/A	18.007	9008350180070	●
M20 X 1.50	D6/D7	18.376 - 18.676	4	16.00	12.00	125.00	N/A	20.007	9008350200070	●
M22 X 1.50	D6/D7	20.376 - 20.676	5	18.00	14.50	125.00	N/A	22.007	9008350220070	○
M24 X 1.50	D6/D7	22.376 - 22.676	5	18.00	14.50	140.00	N/A	24.007	9008350240070	●

"Tap drill Range" given is per the Class of Fit shown per Series #
 Additional Tap Drill sizes & percent of thread engagement can be found on pages 229-237.

METRIC

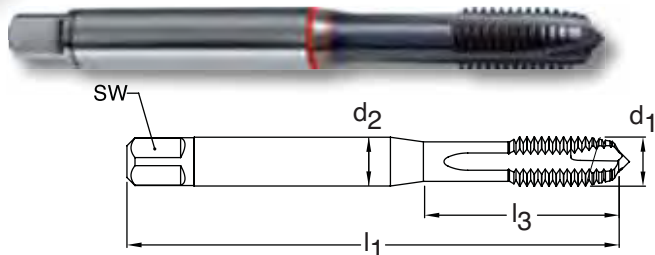

Series 1914
Standard DIN 371
Tool Material HSS-E (Cobalt)
Spiral Point Straight flute
Chamfer Form B • 3.5 - 5
Class of Fit ISO 2(6H)

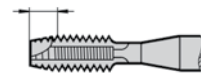

Through holes **TiCN coated** **External cooling**

d1 - P	D Limits	Tap Drill Range mm	Number of Flutes	d2 mm	SW mm	l1 mm	l3 mm	Order Code	EDP Number	Stock
M2 X 0.40	D2/D3	1.567 - 1.679	3	2.80	2.10	45.00	13.50	2.000	9019140020000	○
M2.2 X 0.45	D2/D3	1.713 - 1.838	3	2.80	2.10	45.00	14.50	2.200	9019140022000	●
M2.5 X 0.45	D2/D3	2.013 - 2.138	3	2.80	2.10	50.00	14.50	2.500	9019140025000	●
M2.6 X 0.45	D2/D3	2.110 - 2.240	3	2.80	2.10	50.00	14.50	2.600	9019140026000	○
M3 X 0.50	D2/D3	2.459 - 2.599	3	3.50	2.70	56.00	18.00	3.000	9019140030000	●
M4 X 0.70	D3/D4	3.242 - 3.422	3	4.50	3.40	63.00	21.00	4.000	9019140040000	●
M5 X 0.80	D3/D4	4.134 - 4.334	3	6.00	4.90	70.00	25.00	5.000	9019140050000	○
M6 X 1.00	D4/D5	4.917 - 5.153	3	6.00	4.90	80.00	30.00	6.000	9019140060000	●
M8 X 1.25	D4/D5	6.647 - 6.912	3	8.00	6.20	90.00	35.00	8.000	9019140080000	●
M10 X 1.50	D4/D5	8.376 - 8.676	3	10.00	8.00	100.00	39.00	10.000	9019140100000	●

METRIC

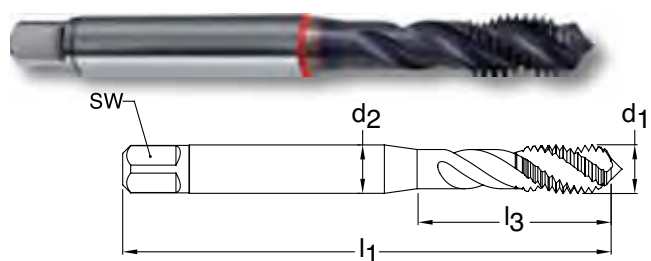

Series 1916
Standard DIN 371
Tool Material HSS-E (Cobalt)
Spiral Flute 40° Helix
Chamfer Form C • 2-3
Class of Fit ISO 2(6H)



Blind holes **TiCN coated** **External cooling**

d1 - P	D Limits	Tap Drill Range mm	Number of Flutes	d2 mm	SW mm	l1 mm	l3 mm	Order Code	EDP Number	Stock
M2 X 0.40	D2/D3	1.567 - 1.679	3	2.80	2.10	45.00	13.50	2.000	9019160020000	●
M3 X 0.50	D2/D3	2.459 - 2.599	3	3.50	2.70	56.00	18.00	3.000	9019160030000	○
M3.5 X 0.60	D3/D4	2.850 - 3.010	3	4.00	3.00	56.00	20.00	3.500	9019160035000	○
M4 X 0.70	D3/D4	3.242 - 3.422	3	4.50	3.40	63.00	21.00	4.000	9019160040000	●
M5 X 0.80	D3/D4	4.134 - 4.334	3	6.00	4.90	70.00	25.00	5.000	9019160050000	○
M6 X 1.00	D4/D5	4.917 - 5.153	3	6.00	4.90	80.00	30.00	6.000	9019160060000	●
M7 X 1.00	D4/D5	5.917 - 6.153	3	7.00	5.50	80.00	30.00	7.000	9019160070000	○
M8 X 1.25	D4/D5	6.647 - 6.912	3	8.00	6.20	90.00	35.00	8.000	9019160080000	●
M10 X 1.50	D4/D5	8.376 - 8.676	3	10.00	8.00	100.00	39.00	10.000	9019160100000	●

METRIC

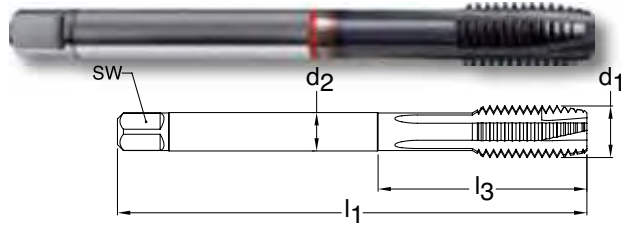

Series 1915
Standard DIN 376
Tool Material HSS-E (Cobalt)
Spiral Point Straight flute
Chamfer Form B • 3.5 - 5
Class of Fit ISO 2(6H)

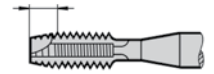

Through holes

TiCN coated

External cooling

d1 - P	D Limits	Tap Drill Range mm	Number of Flutes	d2 mm	SW mm	l1 mm	l3 mm	Order Code	EDP Number	Stock
M3 X 0.50	D2/D3	2.459 - 2.599	3	2.20	N/A	56.00	N/A	3.000	9019150030000	○
M4 X 0.70	D3/D4	3.242 - 3.422	3	2.80	2.10	63.00	N/A	4.000	9019150040000	○
M5 X 0.80	D3/D4	4.134 - 4.334	3	3.50	2.70	70.00	N/A	5.000	9019150050000	○
M6 X 1.00	D4/D5	4.917 - 5.153	3	4.50	3.40	80.00	N/A	6.000	9019150060000	○
M8 X 1.25	D4/D5	6.647 - 6.912	3	6.00	4.90	90.00	N/A	8.000	9019150080000	○
M10 X 1.50	D4/D5	8.376 - 8.676	3	7.00	5.50	100.00	N/A	10.000	9019150100000	○
M12 X 1.75	D5/D6	10.106 - 10.441	4	9.00	7.00	110.00	N/A	12.000	9019150120000	●
M14 X 2.00	D5/D6	11.835 - 12.210	4	11.00	9.00	110.00	N/A	14.000	9019150140000	○
M16 X 2.00	D6/D7	13.835 - 14.210	4	12.00	9.00	110.00	N/A	16.000	9019150160000	○
M18 X 2.50	D6/D7	15.294 - 15.744	4	14.00	11.00	125.00	N/A	18.000	9019150180000	○
M20 X 2.50	D6/D7	17.294 - 17.744	4	16.00	12.00	140.00	N/A	20.000	9019150200000	●
M24 X 3.00	D7/D8	20.752 - 21.252	4	18.00	14.50	160.00	N/A	24.000	9019150240000	●

METRIC

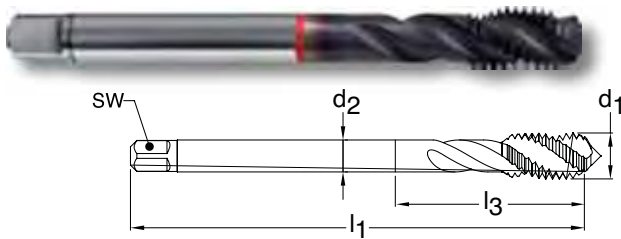

Series 1917
Standard DIN 376
Tool Material HSS-E (Cobalt)
Spiral Flute 40° Helix
Chamfer Form C • 2-3
Class of Fit ISO 2(6H)

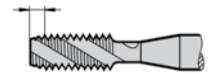

Blind holes

TiCN coated

External cooling

d1 - P	D Limits	Tap Drill Range mm	Number of Flutes	d2 mm	SW mm	l1 mm	l3 mm	Order Code	EDP Number	Stock
M3 X 0.50	D2/D3	2.459 - 2.599	3	2.20	N/A	56.00	N/A	3.000	9019170030000	●
M4 X 0.70	D3/D4	3.242 - 3.422	3	2.80	2.10	63.00	N/A	4.000	9019170040000	○
M5 X 0.80	D3/D4	4.134 - 4.334	3	3.50	2.70	70.00	N/A	5.000	9019170050000	●
M6 X 1.00	D4/D5	4.917 - 5.153	3	4.50	3.40	80.00	N/A	6.000	9019170060000	○
M8 X 1.25	D4/D5	6.647 - 6.912	3	6.00	4.90	90.00	N/A	8.000	9019170080000	●
M10 X 1.50	D4/D5	8.376 - 8.676	3	7.00	5.50	100.00	N/A	10.000	9019170100000	●
M12 X 1.75	D5/D6	10.106 - 10.441	3	9.00	7.00	110.00	N/A	12.000	9019170120000	●
M14 X 2.00	D5/D6	11.835 - 12.210	3	11.00	9.00	110.00	N/A	14.000	9019170140000	●
M16 X 2.00	D6/D7	13.835 - 14.210	4	12.00	9.00	110.00	N/A	16.000	9019170160000	○
M18 X 2.50	D6/D7	15.294 - 15.744	4	14.00	11.00	125.00	N/A	18.000	9019170180000	○
M20 X 2.50	D6/D7	17.294 - 17.744	4	16.00	12.00	140.00	N/A	20.000	9019170200000	●
M22 X 2.50	D6/D7	19.294 - 19.744	5	18.00	14.50	140.00	N/A	22.000	9019170220000	○
M24 X 3.00	D7/D8	20.752 - 21.252	5	18.00	14.50	160.00	N/A	24.000	9019170240000	●
M30 X 3.50	D7/D8	26.211 - 26.771	5	22.00	18.00	180.00	N/A	30.000	9019170300000	●

"Tap drill Range" given is per the Class of Fit shown per Series #
 Additional Tap Drill sizes & percent of thread engagement can be found on pages 229-237.

METRIC

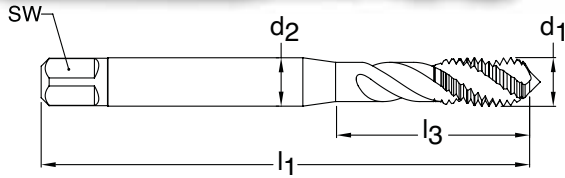

Blind holes



bright finish



Axial coolant

Series 1894
Standard DIN 371
Tool Material HSS-E (Cobalt)
Spiral Flute 40° Helix
Chamfer Form C • 2-3
Class of Fit ISO 2(6H)



d1 - P	D Limits	Tap Drill Range mm	Number of Flutes	d2 mm	SW mm	l1 mm	l3 mm	Order Code	EDP Number	Stock
M5 X 0.80	D3/D4	4.134 - 4.334	3	6.00	4.90	70.00	25.00	5.000	9018940050000	●
M6 X 1.00	D4/D5	4.917 - 5.153	3	6.00	4.90	80.00	30.00	6.000	9018940060000	○
M8 X 1.25	D4/D5	6.647 - 6.912	3	8.00	6.20	90.00	35.00	8.000	9018940080000	●
M10 X 1.50	D4/D5	8.376 - 8.676	3	10.00	8.00	100.00	39.00	10.000	9018940100000	○

METRIC

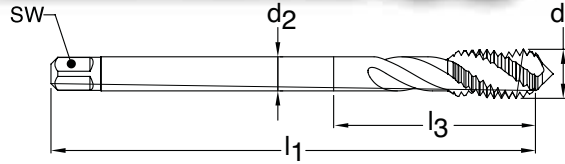

Blind holes



bright finish



Axial coolant

Series 1901
Standard DIN 376
Tool Material HSS-E (Cobalt)
Spiral Flute 40° Helix
Chamfer Form C • 2-3
Class of Fit ISO 2(6H)



d1 - P	D Limits	Tap Drill Range mm	Number of Flutes	d2 mm	SW mm	l1 mm	l3 mm	Order Code	EDP Number	Stock
M12 X 1.75	D5/D6	10.106 - 10.441	3	9.00	7.00	110.00	N/A	12.000	9019010120000	○
M14 X 2.00	D5/D6	11.835 - 12.210	3	11.00	9.00	110.00	N/A	14.000	9019010140000	●
M16 X 2.00	D6/D7	13.835 - 14.210	4	12.00	9.00	110.00	N/A	16.000	9019010160000	●
M18 X 2.50	D6/D7	15.294 - 15.744	4	14.00	11.00	125.00	N/A	18.000	9019010180000	○
M20 X 2.50	D6/D7	17.294 - 17.744	4	16.00	12.00	140.00	N/A	20.000	9019010200000	●

METRIC

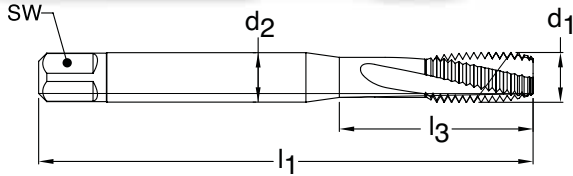

Blind holes



TiAlN coated



External cooling

Series 1577
Standard DIN 371
Tool Material HSS-E PM
Spiral Flute 15° Helix
Chamfer Form C • 2-3
Class of Fit ISO 2(6H)



d1 - P	D Limits	Tap Drill Range mm	Number of Flutes	d2 mm	SW mm	l1 mm	l3 mm	Order Code	EDP Number	Stock
M4 X 0.70	D3/D4	3.242 - 3.422	3	4.50	3.40	63.00	21.00	4.000	9015770040000	○
M5 X 0.80	D3/D4	4.134 - 4.334	3	6.00	4.90	70.00	25.00	5.000	9015770050000	●
M6 X 1.00	D4/D5	4.917 - 5.153	3	6.00	4.90	80.00	30.00	6.000	9015770060000	●
M8 X 1.25	D4/D5	6.647 - 6.912	3	8.00	6.20	90.00	35.00	8.000	9015770080000	●
M10 X 1.50	D4/D5	8.376 - 8.676	3	10.00	8.00	100.00	39.00	10.000	9015770100000	●

METRIC

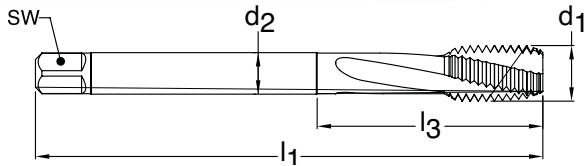

Blind holes



TiAlN coated



External cooling

Series 1578
Standard DIN 376
Tool Material HSS-E PM
Spiral Flute 15° Helix
Chamfer Form C • 2-3
Class of Fit ISO 2(6H)



d1 - P	D Limits	Tap Drill Range mm	Number of Flutes	d2 mm	SW mm	l1 mm	l3 mm	Order Code	EDP Number	Stock
M12 X 1.75	D5/D6	10.106 - 10.441	3	9.00	7.00	110.00	N/A	12.000	9015780120000	●
M16 X 2.00	D6/D7	13.835 - 14.210	4	12.00	9.00	110.00	N/A	16.000	9015780160000	○
M20 X 2.50	D6/D7	17.294 - 17.744	4	16.00	12.00	140.00	N/A	20.000	9015780200000	●

METRIC

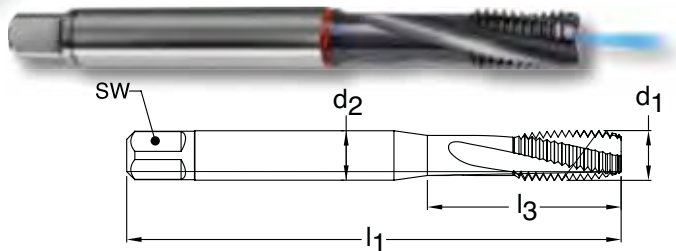

Blind holes



TiCN coated



Axial coolant

Series 1188
Standard DIN 371
Tool Material HSS-E PM
Spiral Flute 15° Helix
Chamfer Form C • 2-3
Class of Fit 6HX

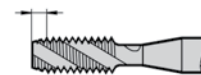

d1 - P	D Limits	Tap Drill Range mm	Number of Flutes	d2 mm	SW mm	l1 mm	l3 mm	Order Code	EDP Number	Stock
M6 X 1.00	D5/D6	4.917 - 5.153	3	6.00	4.90	80.00	30.00	6.000	9011880060000	○
M8 X 1.25	D5/D6	6.647 - 6.912	3	8.00	6.20	90.00	35.00	8.000	9011880080000	○
M10 X 1.50	D5/D6	8.376 - 8.676	3	10.00	8.00	100.00	39.00	10.000	9011880100000	●

METRIC

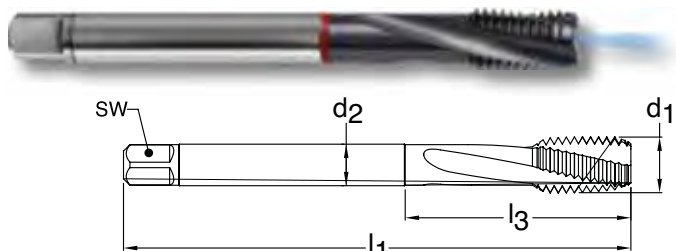

Blind holes



TiCN coated



Axial coolant

Series 1194
Standard DIN 376
Tool Material HSS-E PM
Spiral Flute 15° Helix
Chamfer Form C • 2-3
Class of Fit 6HX



d1 - P	D Limits	Tap Drill Range mm	Number of Flutes	d2 mm	SW mm	l1 mm	l3 mm	Order Code	EDP Number	Stock
M12 X 1.75	D5/D6	10.106 - 10.441	4	9.00	7.00	110.00	N/A	12.000	9011940120000	●
M14 X 2.00	D5/D6	11.835 - 12.210	4	11.00	9.00	110.00	N/A	14.000	9011940140000	●
M16 X 2.00	D7/D8	13.835 - 14.210	4	12.00	9.00	110.00	N/A	16.000	9011940160000	○
M20 X 2.50	D7/D8	17.294 - 17.744	5	16.00	12.00	140.00	N/A	20.000	9011940200000	○
M24 X 3.00	D8/D9	20.752 - 21.252	5	18.00	14.50	160.00	N/A	24.000	9011940240000	○

METRIC FINE

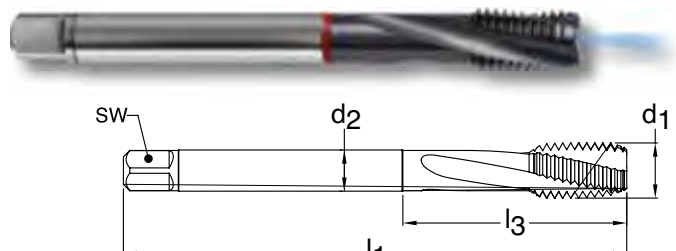

Blind holes



TiCN coated



Axial coolant

Series 1200
Standard DIN 374
Tool Material HSS-E-PM
Spiral Flute 15° Helix
Chamfer Form C • 2-3
Class of Fit 6HX



d1 - P	D Limits	Tap Drill Range mm	Number of Flutes	d2 mm	SW mm	l1 mm	l3 mm	Order Code	EDP Number	Stock
M9 X 1.00	D5/D6	7.917 - 8.153	4	7.00	5.50	90.00	N/A	9.005	9012000090050	○
M10 X 1.00	D5/D6	8.917 - 9.153	4	7.00	5.50	90.00	N/A	10.005	9012000100050	○
M12 X 1.00	D5/D6	10.917 - 11.153	4	9.00	7.00	100.00	N/A	12.005	9012000120050	○
M12 X 1.25	D5/D6	10.647 - 10.912	4	9.00	7.00	100.00	N/A	12.006	9012000120060	●
M12 X 1.50	D5/D6	10.376 - 10.676	4	9.00	7.00	100.00	N/A	12.007	9012000120070	○
M14 X 1.50	D5/D6	12.376 - 12.676	4	11.00	9.00	100.00	N/A	14.007	9012000140070	○
M16 X 1.50	D5/D6	14.376 - 14.676	5	12.00	9.00	100.00	N/A	16.007	9012000160070	○
M18 X 1.50	D5/D6	16.376 - 16.676	5	14.00	11.00	110.00	N/A	18.007	9012000180070	○
M20 X 1.50	D7/D8	18.376 - 18.676	6	16.00	12.00	125.00	N/A	20.007	9012000200070	○
M24 X 1.50	D7/D8	22.376 - 22.676	6	18.00	14.50	140.00	N/A	24.007	9012000240070	○

METRIC

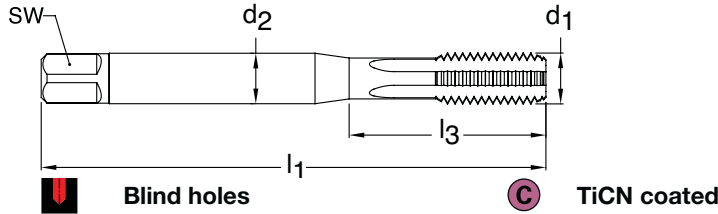

Series 302
Standard DIN 371
Tool Material HSS-E-PM
Flute Straight Flute
Chamfer Form C • 2-3
Class of Fit 6HX



d1 - P	D Limits	Tap Drill Range mm	Number of Flutes	d2 mm	SW mm	l1 mm	l3 mm	Order Code	EDP Number	Stock
M5 X 0.80	D4/D5	4.134 - 4.334	3	6.00	4.90	70.00	25.00	5.000	9003020050000	○
M6 X 1.00	D5/D6	4.917 - 5.153	3	6.00	4.90	80.00	30.00	6.000	9003020060000	●
M8 X 1.25	D5/D6	6.647 - 6.912	3	8.00	6.20	90.00	35.00	8.000	9003020080000	●
M10 X 1.50	D5/D6	8.376 - 8.676	3	10.00	8.00	100.00	39.00	10.000	9003020100000	●

METRIC

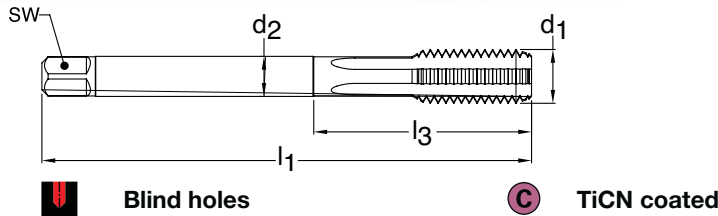

Series 297
Standard DIN 376
Tool Material HSS-E-PM
Flute Straight Flute
Chamfer Form C • 2-3
Class of Fit 6HX



d1 - P	D Limits	Tap Drill Range mm	Number of Flutes	d2 mm	SW mm	l1 mm	l3 mm	Order Code	EDP Number	Stock
M10 X 1.50	D5/D6	8.376 - 8.676	3	7.00	5.50	100.00	N/A	10.000	9002970100000	●
M12 X 1.75	D6/D7	10.106 - 10.441	3	9.00	7.00	110.00	N/A	12.000	9002970120000	●
M14 X 2.00	D6/D7	11.835 - 12.210	3	11.00	9.00	110.00	N/A	14.000	9002970140000	○

METRIC FINE

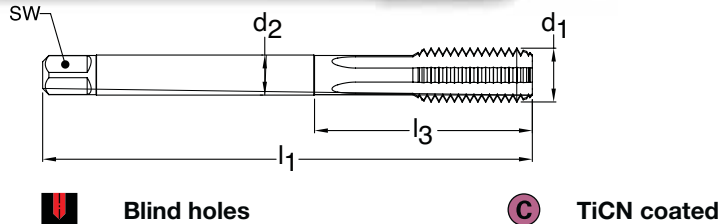

Series 1090
Standard DIN 374
Tool Material HSS-E-PM
Flute Straight Flute
Chamfer Form C • 2-3
Class of Fit 6HX



d1 - P	D Limits	Tap Drill Range mm	Number of Flutes	d2 mm	SW mm	l1 mm	l3 mm	Order Code	EDP Number	Stock
M5 X 0.50	D4/D5	4.459 - 4.599	3	3.50	2.70	70.00	N/A	5.003	9010900050030	○
M6 X 0.50	D5/D6	5.460 - 5.600	3	4.50	3.40	80.00	N/A	6.003	9010900060030	○
M6 X 0.75	D5/D6	5.188 - 5.378	3	4.50	3.40	80.00	N/A	6.004	9010900060040	○
M8 X 0.75	D5/D6	7.188 - 7.378	3	6.00	4.90	80.00	N/A	8.004	9010900080040	○
M8 X 1.00	D5/D6	6.917 - 7.153	3	6.00	4.90	90.00	N/A	8.005	9010900080050	●
M10 X 1.00	D5/D6	8.917 - 9.153	3	7.00	5.50	90.00	N/A	10.005	9010900100050	●
M10 X 1.25	D5/D6	8.647 - 8.912	3	7.00	5.50	100.00	N/A	10.006	9010900100060	○
M12 X 1.00	D5/D6	10.917 - 11.153	3	9.00	7.00	100.00	N/A	12.005	9010900120050	●
M12 X 1.25	D5/D6	10.647 - 10.912	3	9.00	7.00	100.00	N/A	12.006	9010900120060	●
M12 X 1.50	D5/D6	10.376 - 10.676	3	9.00	7.00	100.00	N/A	12.007	9010900120070	●
M14 X 1.50	D5/D6	12.376 - 12.676	3	11.00	9.00	100.00	N/A	14.007	9010900140070	●
M16 X 1.50	D5/D6	14.376 - 14.676	4	12.00	9.00	100.00	N/A	16.007	9010900160070	○

"Tap drill Range" given is per the Class of Fit shown per Series #
 Additional Tap Drill sizes & percent of thread engagement can be found on pages 229-237.

METRIC

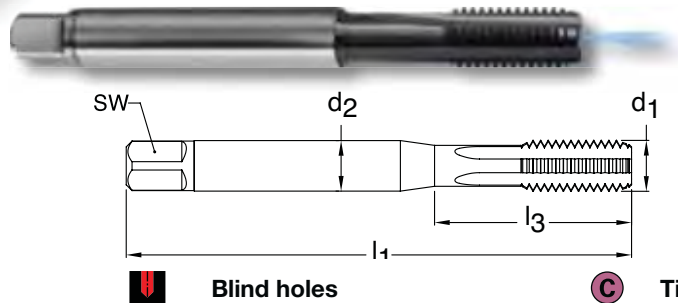

Blind holes



TiCN coated



Axial coolant

Chamfer Form E • 1.5 - 2

Series 1091
Standard DIN 371
Tool Material HSS-E-PM
Flute Straight Flute

Class of Fit 6HX



d1 - P	D Limits	Tap Drill Range mm	Number of Flutes	d2 mm	SW mm	l1 mm	l3 mm	Order Code	EDP Number	Stock
M5 X 0.80	D4/D5	4.134 - 4.334	3	6.00	4.90	70.00	25.00	5.000	9010910050000	○
M6 X 1.00	D5/D6	4.917 - 5.153	3	6.00	4.90	80.00	30.00	6.000	9010910060000	●
M8 X 1.25	D5/D6	6.647 - 6.912	3	8.00	6.20	90.00	35.00	8.000	9010910080000	●
M10 X 1.50	D5/D6	8.376 - 8.676	3	10.00	8.00	100.00	39.00	10.000	9010910100000	●

METRIC

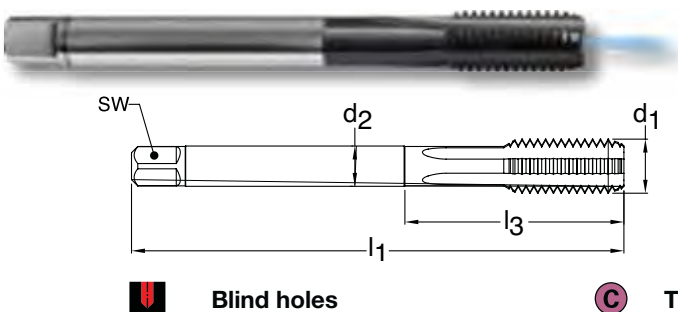

Blind holes



TiCN coated



Axial coolant

Chamfer Form E • 1.5 - 2

Series 4165
Standard DIN 376
Tool Material HSS-E-PM
Flute Straight Flute

Class of Fit 6HX

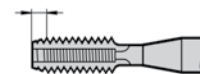

d1 - P	D Limits	Tap Drill Range mm	Number of Flutes	d2 mm	SW mm	l1 mm	l3 mm	Order Code	EDP Number	Stock
M10 X 1.50	D5/D6	8.376 - 8.676	3	7.00	5.50	100.00	N/A	10.000	9041650100000	○
M12 X 1.75	D6/D7	10.106 - 10.441	3	9.00	7.00	110.00	N/A	12.000	9041650120000	○
M16 X 2.00	D7/D8	13.835 - 14.210	4	12.00	9.00	110.00	N/A	16.000	9041650160000	○
M20 X 2.50	D7/D8	17.294 - 17.744	4	16.00	12.00	140.00	N/A	20.000	9041650200000	○

METRIC FINE

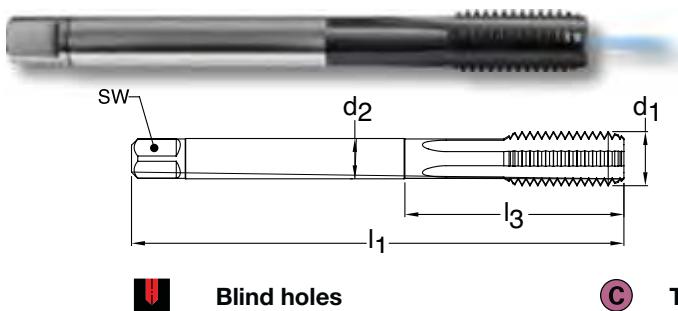

Blind holes



TiCN coated



Axial coolant

Chamfer Form E • 1.5 - 2

Series 1007
Standard DIN 374
Tool Material HSS-E-PM
Flute Straight Flute

Class of Fit 6HX

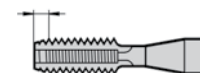

d1 - P	D Limits	Tap Drill Range mm	Number of Flutes	d2 mm	SW mm	l1 mm	l3 mm	Order Code	EDP Number	Stock
M5 X 0.50	D4/D5	4.459 - 4.599	3	3.50	2.70	70.00	N/A	5.003	9010070050030	○
M6 X 0.50	D5/D6	5.460 - 5.600	3	4.50	3.40	80.00	N/A	6.003	9010070060030	○
M6 X 0.75	D5/D6	5.188 - 5.378	3	4.50	3.40	80.00	N/A	6.004	9010070060040	○
M8 X 0.75	D5/D6	7.188 - 7.378	3	6.00	4.90	80.00	N/A	8.004	9010070080040	○
M8 X 1.00	D5/D6	6.917 - 7.153	3	6.00	4.90	90.00	N/A	8.005	9010070080050	●
M9 X 1.00	D5/D6	7.917 - 8.153	3	7.00	5.50	90.00	N/A	9.005	9010070090050	●
M10 X 1.00	D5/D6	8.917 - 9.153	3	7.00	5.50	90.00	N/A	10.005	9010070100050	●
M10 X 1.25	D5/D6	8.647 - 8.912	3	7.00	5.50	100.00	N/A	10.006	9010070100060	●
M12 X 1.00	D5/D6	10.917 - 11.153	3	9.00	7.00	100.00	N/A	12.005	9010070120050	○
M12 X 1.25	D5/D6	10.647 - 10.912	3	9.00	7.00	100.00	N/A	12.006	9010070120060	●
M12 X 1.50	D5/D6	10.376 - 10.676	3	9.00	7.00	100.00	N/A	12.007	9010070120070	●
M14 X 1.00	D5/D6	12.917 - 13.153	3	11.00	9.00	100.00	N/A	14.005	9010070140050	○
M14 X 1.25	D5/D6	12.647 - 12.912	3	11.00	9.00	100.00	N/A	14.006	9010070140060	●
M14 X 1.50	D5/D6	12.376 - 12.676	3	11.00	9.00	100.00	N/A	14.007	9010070140070	●
M16 X 1.00	D5/D6	14.917 - 15.153	4	12.00	9.00	100.00	N/A	16.005	9010070160050	○
M16 X 1.50	D5/D6	14.376 - 14.676	4	12.00	9.00	100.00	N/A	16.007	9010070160070	●

METRIC

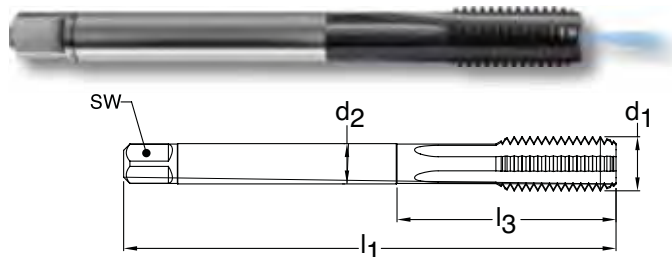

Series 778
Standard DIN 376
Tool Material HSS-E (Cobalt)
Flute Straight Flute
Chamfer Form C • 2-3
Class of Fit 6HX



Through holes **Blind holes** **TiCN coated** **Axial coolant**

d1 - P	D Limits	Tap Drill Range mm	Number of Flutes	d2 mm	SW mm	l1 mm	l3 mm	Order Code	EDP Number	Stock
M16 X 2.00	D7/D8	13.835 - 14.210	4	12.00	9.00	110.00	N/A	16.000	9007780160000	●
M20 X 2.50	D7/D8	17.294 - 17.744	4	16.00	12.00	140.00	N/A	20.000	9007780200000	○
M24 X 3.00	D8/D9	20.752 - 21.252	5	18.00	14.50	160.00	N/A	24.000	9007780240000	●
M27 X 3.00	D8/D9	23.752 - 24.252	5	20.00	16.00	160.00	N/A	27.000	9007780270000	○
M30 X 3.50	D9/D10	26.211 - 26.771	5	22.00	18.00	180.00	N/A	30.000	9007780300000	●
M33 X 3.50	D9/D10	31.376 - 31.676	6	25.00	20.00	180.00	N/A	33.000	9007780330000	○
M36 X 4.00	D9/D10	31.670 - 32.270	6	28.00	22.00	200.00	N/A	36.000	9007780360000	○
M39 X 4.00	D10/D11	34.690 - 35.780	6	32.00	24.00	200.00	N/A	39.000	9007780390000	○

METRIC - EXTENDED LENGTH

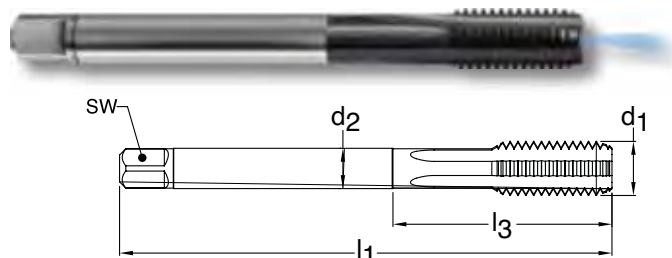

Series 779
Standard ~DIN 376
Tool Material HSS-E (Cobalt)
Flute Straight Flute
Chamfer Form C • 2-3
Class of Fit 6HX



Blind holes **TiCN coated** **Axial coolant**

d1 - P	D Limits	Tap Drill Range mm	Number of Flutes	d2 mm	SW mm	l1 mm	l3 mm	Order Code	EDP Number	Stock
M16 X 2.00	D7/D8	13.835 - 14.210	3	12.00	9.00	160.00	N/A	16.000	9007790160000	○
M20 X 2.50	D7/D8	17.294 - 17.744	3	16.00	12.00	180.00	N/A	20.000	9007790200000	○
M24 X 3.00	D8/D9	20.752 - 21.252	4	18.00	14.50	200.00	N/A	24.000	9007790240000	○
M27 X 3.00	D8/D9	23.752 - 24.252	4	20.00	16.00	225.00	N/A	27.000	9007790270000	○
M30 X 3.50	D9/D10	26.211 - 26.711	4	22.00	18.00	250.00	N/A	30.000	9007790300000	○
M33 X 3.50	D9/D10	29.211 - 29.711	4	25.00	20.00	275.00	N/A	33.000	9007790330000	○
M36 X 4.00	D9/D10	31.670 - 32.270	5	28.00	22.00	300.00	N/A	36.000	9007790360000	○
M39 X 4.00	D10/D11	34.690 - 35.780	5	32.00	24.00	325.00	N/A	39.000	9007790390000	○

"Tap drill Range" given is per the Class of Fit shown per Series #
 Additional Tap Drill sizes & percent of thread engagement can be found on pages 229-237.

METRIC

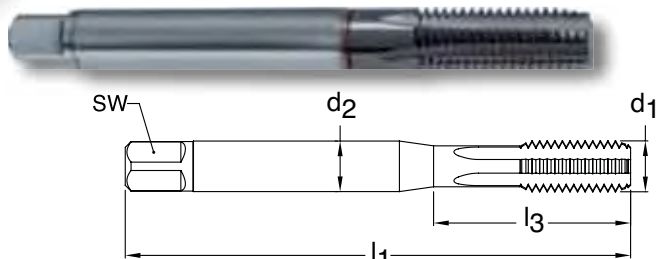

Series 2944
Standard Guhring Standard
Tool Material Carbide
Flute Straight Flute
Chamfer Form D • 3.5 - 5
Class of Fit ISO 2(6H)



Through holes **Blind holes** **TiCN coated** **External cooling**

d1 - P	D Limits	Number of Flutes	d2 inch	SW inch	Tap Drill Range mm	l1 mm	l3 mm	Order Code	EDP Number	Stock
M3 X 0.50	D2/D3	3	3.50	2.70	2.459 - 2.599	56.00	14.00	3.000	9029440030000	○
M4 X 0.70	D3/D4	4	4.50	3.40	3.242 - 3.422	63.00	17.00	4.000	9029440040000	○
M5 X 0.80	D3/D4	4	6.00	4.90	4.134 - 4.334	70.00	21.00	5.000	9029440050000	●
M6 X 1.00	D4/D5	4	6.00	4.90	4.917 - 5.153	80.00	26.00	6.000	9029440060000	●
M8 X 1.25	D4/D5	5	8.00	6.20	6.647 - 6.912	90.00	31.00	8.000	9029440080000	●
M10 X 1.50	D4/D5	5	10.00	8.00	8.376 - 8.676	100.00	N/A	10.000	9029440100000	●
M12 X 1.75	D5/D6	5	12.00	9.00	10.106 - 10.441	110.00	N/A	12.000	9029440120000	●
M16 X 2.00	D6/D7	5	16.00	12.00	13.835 - 14.210	110.00	N/A	16.000	9029440160000	○

METRIC FINE

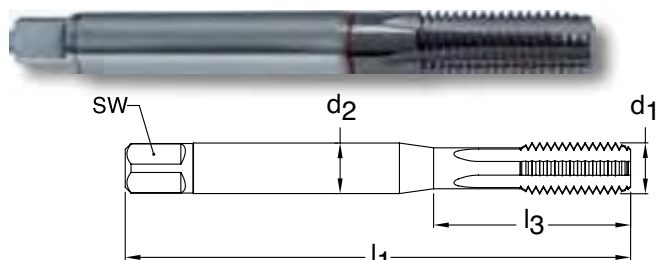

Series 1161
Standard Guhring Standard
Tool Material Carbide
Flute Straight Flute
Chamfer Form D • 3.5 - 5
Class of Fit ISO 2(6H)

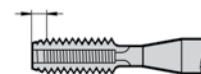

Through holes **Blind holes** **TiCN coated** **External cooling**

d1 - P	D Limits	Tap Drill Range mm	Number of Flutes	d2 inch	SW inch	l1 mm	l3 mm	Order Code	EDP Number	Stock
M6 X 0.50	D4/D5	5.460 - 5.600	4	6.00	4.90	80.00	16.00	6.003	9011610060030	○
M8 X 1.00	D4/D5	6.917 - 7.153	5	8.00	6.20	90.00	20.00	8.005	9011610080050	○
M10 X 1.00	D4/D5	8.917 - 9.153	5	10.00	8.00	90.00	24.00	10.005	9011610100050	●
M12 X 1.00	D4/D5	10.917 - 11.153	5	12.00	9.00	100.00	26.00	12.005	9011610120050	○
M12 X 1.50	D4/D5	10.376 - 10.676	5	12.00	9.00	100.00	30.00	12.007	9011610120070	●

TECH TIP: Type D Form

A type D chamfer form has a 3.5 - 5 thread chamfer lead. This chamfer can be used in both through holes and in blind holes when the tap drill depth permits this chamfer length. This is especially useful when tapping harder materials due to the EXTENDED chamfer length which distributes the thread cutting process over more cutting edges. The D chamfer form is usually found on rigid, straight fluted tap designs.

Carbide Thread Milling Cutters

Standard Offering:

- Solid carbide or coolant fed carbide thread mills
- Thread depth 2 x D or 2.5 x D
- TiCN coating for exceptional heat- and wear-resistance
- UNC, UNF, Metric and Metric Fine sizes; also NPT and NPTF
- DTMC thread mills drill and cut threads with the same tool
- TMU thread mills capable of creating more than one diameter of the same thread form





TI / NI CUT TAPS

Titanium and Ti-alloys
Nickel and Ni-alloys

Material group	Approximate Rc	Approximate HB	Recommended SFM					
			HSS-E		HSS-E-PM		Solid carbide	
			bright finish	hard coated	bright finish	hard coated	bright finish	hard coated
Titanium and Ti-alloys	—	140-275	—	—	—	20-30	—	—
	—	300-380	—	—	—	10-18	—	—
Nickel and Ni-alloys	—	200-300	—	—	—	10-18	—	—
	—	>300	—	—	—	6-12	—	—

If you have customers who are suppliers to the aerospace or military Industries, you will encounter “J” or “Controlled root radius” thread requirements.

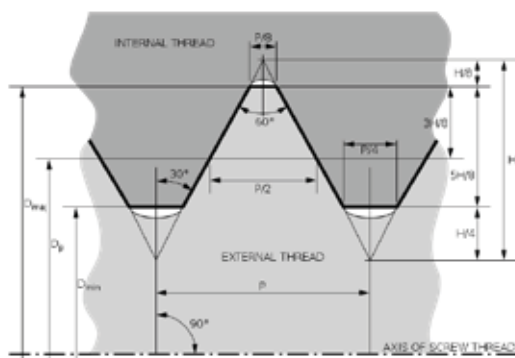

The differences between these and UNC or UNF threads are as follows:

The external thread is manufactured with radii in the root of the thread for added strength, and to extend the integrity of the threading tool.

The internal thread is manufactured to 3B class of fit tolerancing for the pitch diameter, and will need to use a larger drill for the minor diameter to accommodate the root radius in the bolt.

ANY UN-3B tap will produce a legitimate “UNJ” internal thread.

UNC Ti / Ti Alloys

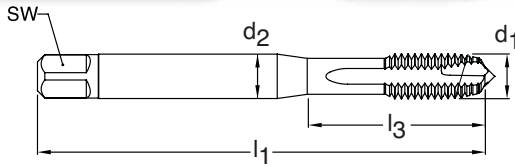

Through holes



TiCN coated



External cooling

Chamfer Form B • 3.5 - 5

Class of Fit 2BX



d1 - P	H Limits	Tap Drill Range inch	Number of Flutes	d2 mm	SW mm	l1 mm	l3 mm	Order Code	EDP Number	Stock
6-32	H4/H5	0.104 - 0.114	3	4.00	3.00	56.00	20.00	3.505	9029050035050	●
8-32	H4/H5	0.130 - 0.139	3	4.50	3.40	63.00	21.00	4.166	9029050041660	●
10-24	H4/H5	0.145 - 0.155	3	6.00	4.90	70.00	25.00	4.826	9029050048260	●
12-24	H4/H5	0.171 - 0.181	3	6.00	4.90	80.00	30.00	5.486	9029050054860	●
1/4-20	H5/H6	0.196 - 0.207	3	7.00	5.50	80.00	30.00	6.350	9029050063500	●
5/16-18	H5/H6	0.252 - 0.265	4	8.00	6.20	90.00	35.00	7.938	9029050079380	●
3/8-16	H6/H7	0.307 - 0.321	4	10.00	8.00	100.00	39.00	9.525	9029050095250	●

UNC Ti / Ti Alloys

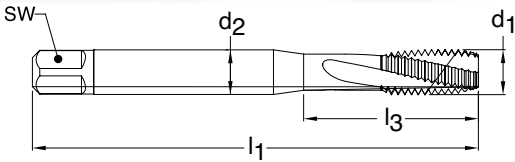

Blind holes



TiCN coated



External cooling

Chamfer Form C • 2-3

Class of Fit 2BX



d1 - P	H Limits	Tap Drill Range inch	Number of Flutes	d2 mm	SW mm	l1 mm	l3 mm	Order Code	EDP Number	Stock
4-40	H3/H4	0.085 - 0.094	3	3.50	2.70	56.00	18.00	2.845	9029120028450	●
5-40	H3/H4	0.098 - 0.106	3	3.50	2.70	56.00	18.00	3.175	9029120031750	●
6-32	H4/H5	0.104 - 0.114	3	4.00	3.00	56.00	20.00	3.505	9029120035050	●
8-32	H4/H5	0.130 - 0.139	3	4.50	3.40	63.00	21.00	4.166	9029120041660	●
10-24	H4/H5	0.145 - 0.155	3	6.00	4.90	70.00	25.00	4.826	9029120048260	●
12-24	H4/H5	0.171 - 0.181	3	6.00	4.90	80.00	30.00	5.486	9029120054860	●
1/4-20	H5/H6	0.196 - 0.207	3	7.00	5.50	80.00	30.00	6.350	9029120063500	●
5/16-18	H5/H6	0.252 - 0.265	3	8.00	6.20	90.00	35.00	7.938	9029120079380	●
3/8-16	H6/H7	0.307 - 0.321	3	10.00	8.00	100.00	39.00	9.525	9029120095250	●
7/16-14	H6/H7	0.360 - 0.376	4	8.00	6.20	100.00	N/A	11.113	9029120111130	●
1/2-13	H6/H7	0.417 - 0.434	4	9.00	7.00	110.00	N/A	12.700	9029120127000	●
5/8-11	H6/H7	0.527 - 0.546	4	12.00	9.00	110.00	N/A	15.875	9029120158750	●

UNF Ti / Ti Alloys

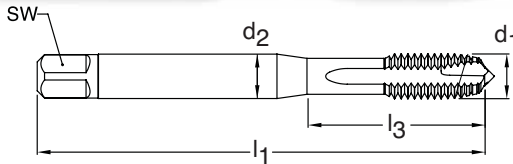

Through holes



TiCN coated



External cooling

Series 2907
Standard DIN 371
Tool Material HSS-E PM
Spiral Point Straight flute
Chamfer Form B • 3.5 - 5
Class of Fit 2BX



d1 - P	H Limits	Tap Drill Range inch	Number of Flutes	d2 mm	SW mm	l1 mm	l3 mm	Order Code	EDP Number	Stock
6-40	H3/H4	0.111 - 0.119	3	4.00	3.00	56.00	20.00	3.505	9029070035050	●
8-36	H3/H4	0.134 - 0.142	3	4.50	3.40	63.00	21.00	4.166	9029070041660	●
10-32	H4/H5	0.156 - 0.164	3	6.00	4.90	70.00	25.00	4.826	9029070048260	●
12-28	H4/H5	0.177 - 0.186	3	6.00	4.90	80.00	30.00	5.486	9029070054860	●
1/4-28	H4/H5	0.211 - 0.220	3	7.00	5.50	80.00	30.00	6.350	9029070063500	●
5/16-24	H4/H5	0.267 - 0.277	4	8.00	6.20	90.00	35.00	7.938	9029070079380	●
3/8-24	H4/H5	0.330 - 0.340	4	10.00	8.00	90.00	35.00	9.525	9029070095250	●

UNF Ti / Ti Alloys

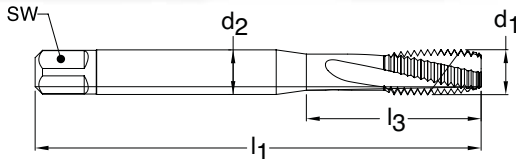

Blind holes



TiCN coated



External cooling

Series 2914
Standard DIN 371/376
Tool Material HSS-E PM
Spiral Flute 15° Helix
Chamfer Form C • 2-3
Class of Fit 2BX

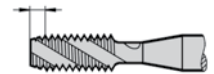

d1 - P	H Limits	Tap Drill Range inch	Number of Flutes	d2 mm	SW mm	l1 mm	l3 mm	Order Code	EDP Number	Stock
4-48	H3/H4	0.089 - 0.097	3	3.50	2.70	56.00	18.00	2.845	9029140028450	●
5-44	H3/H4	0.100 - 0.108	3	3.50	2.70	56.00	18.00	3.175	9029140031750	●
6-40	H3/H4	0.111 - 0.119	3	4.00	3.00	56.00	20.00	3.505	9029140035050	●
8-36	H3/H4	0.134 - 0.142	3	4.50	3.40	63.00	21.00	4.166	9029140041660	●
10-32	H4/H5	0.156 - 0.164	3	6.00	4.90	70.00	25.00	4.826	9029140048260	●
12-28	H4/H5	0.177 - 0.186	3	6.00	4.90	80.00	30.00	5.486	9029140054860	●
1/4-28	H4/H5	0.211 - 0.220	3	7.00	5.50	80.00	30.00	6.350	9029140063500	●
5/16-24	H4/H5	0.267 - 0.277	3	8.00	6.20	90.00	35.00	7.938	9029140079380	●
3/8-24	H4/H5	0.330 - 0.340	3	10.00	8.00	90.00	35.00	9.525	9029140095250	●
7/16-20	H5/H6	0.383 - 0.395	4	8.00	6.20	100.00	N/A	11.113	9029140111130	●
1/2-20	H5/H6	0.446 - 0.457	4	9.00	7.00	100.00	N/A	12.700	9029140127000	●
5/8-18	H5/H6	0.565 - 0.578	4	12.00	9.00	100.00	N/A	15.875	9029140158750	●

METRIC Ti / Ti Alloys

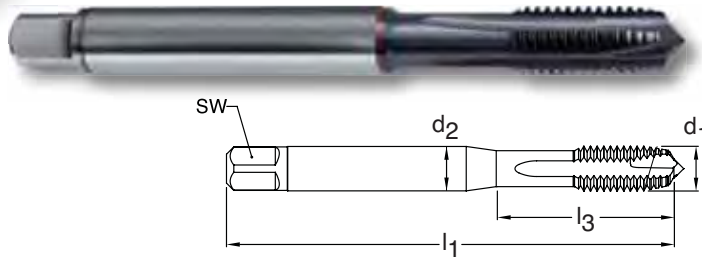

Series 2901
Standard DIN 371/376
Tool Material HSS-E PM
Spiral Point Straight flute
Chamfer Form B • 3.5 - 5
Class of Fit 6HX

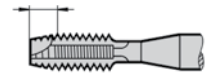

Through holes **TiCN coated** **External cooling**

d1 - P	D Limits	Tap Drill Range mm	Number of Flutes	d2 mm	SW mm	l1 mm	l3 mm	Order Code	EDP Number	Stock
M3 X 0.50	D3/D4	2.459 - 2.599	3	3.50	2.70	56.00	18.00	3.000	9029010030000	●
M4 X 0.70	D4/D5	3.242 - 3.422	3	4.50	3.40	63.00	21.00	4.000	9029010040000	●
M5 X 0.80	D4/D5	4.134 - 4.334	3	6.00	4.90	70.00	25.00	5.000	9029010050000	●
M6 X 1.00	D5/D6	4.917 - 5.153	3	6.00	4.90	80.00	30.00	6.000	9029010060000	●
M8 X 1.25	D5/D6	6.647 - 6.912	4	8.00	6.20	90.00	35.00	8.000	9029010080000	●
M10 X 1.50	D5/D6	8.376 - 8.676	4	10.00	8.00	100.00	39.00	10.000	9029010100000	●
M12 X 1.75	D6/D7	10.106 - 10.441	4	9.00	7.00	110.00	N/A	12.000	9029010120000	●
M16 X 2.0	D7/D8	13.835 - 14.210	4	12.00	9.00	110.00	N/A	16.000	9029010160000	●

METRIC Ti / Ti Alloys

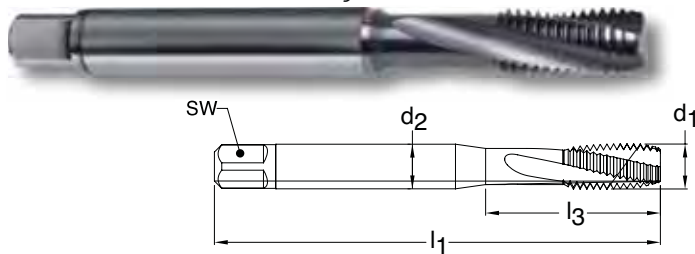

Series 2909
Standard DIN 371/376
Tool Material HSS-E PM
Spiral Flute 15° Helix
Chamfer Form C • 2-3
Class of Fit 6HX

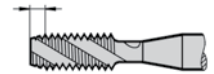

Blind holes **TiCN coated** **External cooling**

d1 - P	D Limits	Tap Drill Range mm	Number of Flutes	d2 mm	SW mm	l1 mm	l3 mm	Order Code	EDP Number	Stock
M3 X 0.50	D3/D4	2.459 - 2.599	3	3.50	2.70	56.00	18.00	3.000	9029090030000	○
M4 X 0.70	D4/D5	3.242 - 3.422	3	4.50	3.40	63.00	21.00	4.000	9029090040000	●
M5 X 0.80	D4/D5	4.134 - 4.334	3	6.00	4.90	70.00	25.00	5.000	9029090050000	○
M6 X 1.00	D5/D6	4.917 - 5.153	3	6.00	4.90	80.00	30.00	6.000	9029090060000	○
M8 X 1.25	D5/D6	6.647 - 6.912	3	8.00	6.20	90.00	35.00	8.000	9029090080000	○
M10 X 1.50	D5/D6	8.376 - 8.676	3	10.00	8.00	100.00	39.00	10.000	9029090100000	○
M12 X 1.75	D6/D7	10.106 - 10.441	4	9.00	7.00	110.00	N/A	12.000	9029090120000	○
M16 X 2.0	D7/D8	13.835 - 14.210	4	12.00	7.00	110.00	N/A	16.000	9029090160000	○

METRIC FINE *Ti / Ti Alloys*

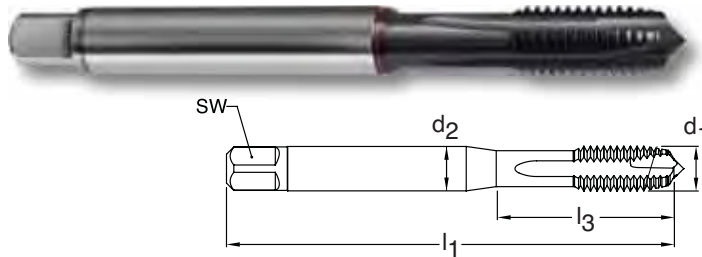

Series 2903
Standard DIN 371
Tool Material HSS-E PM
Spiral Point Straight flute
Chamfer Form B • 3.5 - 5
Class of Fit 6HX

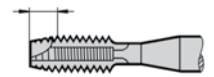

Through holes
 TiCN coated
 External cooling

d1 - P	D Limits	Tap Drill Range mm	Number of Flutes	d2 mm	SW mm	l1 mm	l3 mm	Order Code	EDP Number	Stock
M3 X 0.35	D3/D4	2.621 - 2.721	3	3.50	2.70	56.00	18.00	3.002	9029030030020	●
M4 X 0.50	D4/D5	3.459 - 3.599	3	4.50	3.40	63.00	21.00	4.003	9029030040030	●
M5 X 0.50	D4/D5	4.459 - 4.599	3	6.00	4.90	70.00	25.00	5.003	9029030050030	○
M6 X 0.50	D4/D5	5.460 - 5.600	3	6.00	4.90	80.00	30.00	6.003	9029030060030	●
M6 X 0.75	D4/D5	5.188 - 5.378	3	6.00	4.90	80.00	30.00	6.004	9029030060040	●
M8 X 0.75	D4/D5	7.188 - 7.378	4	8.00	6.20	80.00	30.00	8.004	9029030080040	●
M8 X 1.00	D5/D6	6.917 - 7.153	4	8.00	6.20	90.00	35.00	8.005	9029030080050	○
M10 X 1.00	D5/D6	8.917 - 9.153	4	10.00	8.00	90.00	35.00	10.005	9029030100050	○

METRIC FINE *Ti / Ti Alloys*

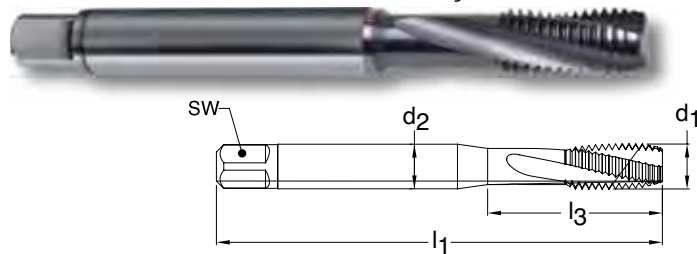

Series 2910
Standard DIN 371
Tool Material HSS-E PM
Spiral Flute 15° Helix
Chamfer Form C • 2-3
Class of Fit 6HX



Blind holes
 TiCN coated
 External cooling

d1 - P	D Limits	Tap Drill Range mm	Number of Flutes	d2 mm	SW mm	l1 mm	l3 mm	Order Code	EDP Number	Stock
M3 X 0.35	D3/D4	2.621 - 2.721	3	3.50	2.70	56.00	18.00	3.002	9029100030020	○
M4 X 0.50	D4/D5	3.459 - 3.599	3	4.50	3.40	63.00	21.00	4.003	9029100040030	○
M5 X 0.50	D4/D5	4.459 - 4.599	3	6.00	4.90	70.00	25.00	5.003	9029100050030	○
M6 X 0.50	D4/D5	5.460 - 5.600	3	6.00	4.90	80.00	30.00	6.003	9029100060030	○
M6 X 0.75	D4/D5	5.188 - 5.378	3	6.00	4.90	80.00	30.00	6.004	9029100060040	○
M8 X 0.75	D4/D5	7.188 - 7.378	3	8.00	6.20	80.00	30.00	8.004	9029100080040	○
M8 X 1.00	D5/D6	6.917 - 7.153	3	8.00	6.20	90.00	35.00	8.005	9029100080050	○
M10 X 1.00	D5/D6	8.917 - 9.153	3	10.00	8.00	90.00	35.00	10.005	9029100100050	○

"Tap drill Range" given is per the Class of Fit shown per Series #
 Additional Tap Drill sizes & percent of thread engagement can be found on pages 229-237.

UNC Ni / Ni Alloys

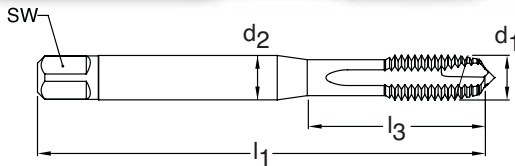

Through holes



TiAlN coated



External cooling

Chamfer Form B • 3.5 - 5

Class of Fit



2BX

d1 - P	H Limits	Tap Drill Range inch	Number of Flutes	d2 mm	SW mm	l1 mm	l3 mm	Order Code	EDP Number	Stock
6-32	H4/H5	0.104 - 0.114	3	4.00	3.00	56.00	20.00	3.505	9029180035050	●
8-32	H4/H5	0.130 - 0.139	3	4.50	3.40	63.00	21.00	4.166	9029180041660	●
10-24	H4/H5	0.145 - 0.155	3	6.00	4.90	70.00	25.00	4.826	9029180048260	●
12-24	H4/H5	0.171 - 0.181	3	6.00	4.90	80.00	30.00	5.486	9029180054860	●
1/4-20	H5/H6	0.196 - 0.207	3	7.00	5.50	80.00	30.00	6.350	9029180063500	●
5/16-18	H5/H6	0.252 - 0.265	4	8.00	6.20	90.00	35.00	7.938	9029180079380	●
3/8-16	H5/H6	0.307 - 0.321	4	10.00	8.00	100.00	39.00	9.525	9029180095250	●

UNC Ni / Ni Alloys

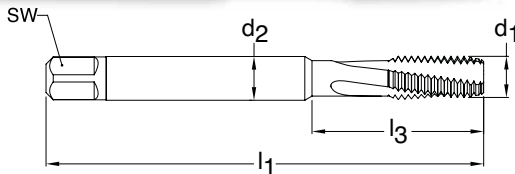

Blind holes



TiAlN coated



External cooling

Chamfer Form C • 2-3

Class of Fit



2BX

d1 - P	H Limits	Tap Drill Range inch	Number of Flutes	d2 mm	SW mm	l1 mm	l3 mm	Order Code	EDP Number	Stock
4-40	H3/H4	0.085 - 0.094	3	3.50	2.70	56.00	18.00	2.845	9029220028450	●
5-40	H3/H4	0.098 - 0.106	3	3.50	2.70	56.00	18.00	3.175	9029220031750	●
6-32	H4/H5	0.104 - 0.114	3	4.00	3.00	56.00	20.00	3.505	9029220035050	●
8-32	H4/H5	0.130 - 0.139	3	4.50	3.40	63.00	21.00	4.166	9029220041660	●
10-24	H4/H5	0.145 - 0.155	3	6.00	4.90	70.00	25.00	4.826	9029220048260	●
12-24	H4/H5	0.171 - 0.181	3	6.00	4.90	80.00	30.00	5.486	9029220054860	●
1/4-20	H5/H6	0.196 - 0.207	3	7.00	5.50	80.00	30.00	6.350	9029220063500	●
5/16-18	H5/H6	0.252 - 0.265	3	8.00	6.20	90.00	35.00	7.938	9029220079380	●
3/8-16	H6/H7	0.307 - 0.321	3	10.00	8.00	100.00	39.00	9.525	9029220095250	●
7/16-14	H6/H7	0.360 - 0.376	4	8.00	6.20	100.00	N/A	11.113	9029220111130	●
1/2-13	H6/H7	0.417 - 0.434	4	9.00	7.00	110.00	N/A	12.700	9029220127000	●
5/8-11	H6/H7	0.527 - 0.546	4	12.00	9.00	110.00	N/A	15.875	9029220158750	●

UNF Ni / Ni Alloys

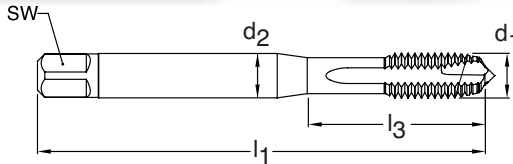

Through holes



TiAlN coated



External cooling

Series 2919
Standard DIN 371
Tool Material HSS-E PM
Spiral Point Straight flute
Chamfer Form B • 3.5 - 5
Class of Fit 2BX

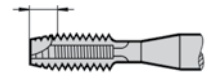

d1 - P	H Limits	Tap Drill Range inch	Number of Flutes	d2 mm	SW mm	l1 mm	l3 mm	Order Code	EDP Number	Stock
6-40	H3/H4	0.111 - 0.119	3	4.00	3.00	56.00	20.00	3.505	9029190035050	●
10-32	H4/H5	0.156 - 0.164	3	6.00	4.90	70.00	25.00	4.826	9029190048260	●
1/4-28	H4/H5	0.211 - 0.220	3	7.00	5.50	80.00	30.00	6.350	9029190063500	●
5/16-24	H4/H5	0.267 - 0.277	4	8.00	6.20	90.00	35.00	7.938	9029190079380	●
3/8-24	H4/H5	0.330 - 0.340	4	10.00	8.00	90.00	35.00	9.525	9029190095250	●

UNF Ni / Ni Alloys

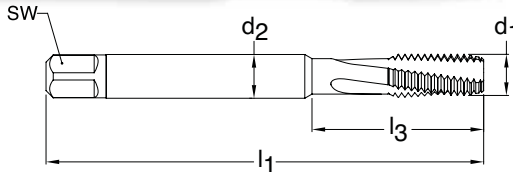

Blind holes



TiAlN coated



External cooling

Series 2923
Standard DIN 371/376
Tool Material HSS-E PM
Spiral Flute 10° Helix
Chamfer Form C • 2-3
Class of Fit 2BX



d1 - P	H Limits	Tap Drill Range mm	Number of Flutes	d2 mm	SW mm	l1 mm	l3 mm	Order Code	EDP Number	Stock
4-48	H3/H4	0.089 - 0.097	3	3.50	2.70	56.00	18.00	2.845	9029230028450	●
5-44	H3/H4	0.100 - 0.108	3	3.50	2.70	56.00	18.00	3.175	9029230031750	●
6-40	H3/H4	0.111 - 0.119	3	4.00	3.00	56.00	20.00	3.505	9029230035050	●
8-36	H3/H4	0.134 - 0.142	3	4.50	3.40	63.00	21.00	4.166	9029230041660	●
10-32	H4/H5	0.156 - 0.164	3	6.00	4.90	70.00	25.00	4.826	9029230048260	●
12-28	H4/H5	0.177 - 0.186	3	6.00	4.90	80.00	30.00	5.486	9029230054860	●
1/4-28	H4/H5	0.211 - 0.220	3	7.00	5.50	80.00	30.00	6.350	9029230063500	●
5/16-24	H4/H5	0.267 - 0.277	3	8.00	6.20	90.00	35.00	7.938	9029230079380	●
3/8-24	H4/H5	0.330 - 0.340	3	10.00	8.00	90.00	35.00	9.525	9029230095250	●
7/16-20	H5/H6	0.383 - 0.395	4	8.00	6.20	100.00	N/A	11.113	9029230111130	●
1/2-20	H5/H6	0.446 - 0.457	4	9.00	7.00	100.00	N/A	12.700	9029230127000	●
5/8-18	H5/H6	0.565 - 0.578	4	12.00	9.00	100.00	N/A	15.875	9029230158750	●

METRIC Ni / Ni Alloys

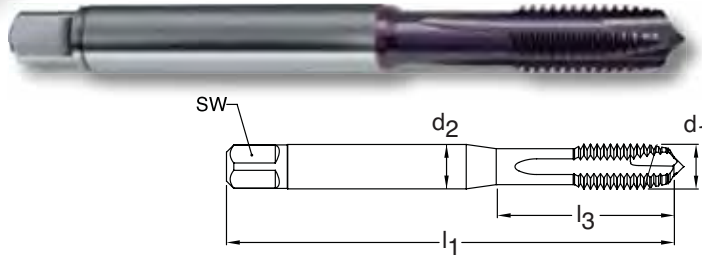

Series 2916
Standard DIN 371/376
Tool Material HSS-E PM
Spiral Point Straight flute
Chamfer Form B • 3.5 - 5
Class of Fit 6HX

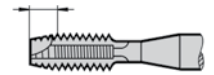

Through holes **TiAlN coated** **External cooling**

d1 - P	D Limits	Tap Drill Range mm	Number of Flutes	d2 mm	SW mm	l1 mm	l3 mm	Order Code	EDP Number	Stock
M3 X 0.50	D3/D4	2.459 - 2.599	3	3.50	2.70	56.00	18.00	3.000	9029160030000	●
M4 X 0.70	D4/D5	3.242 - 3.422	3	4.50	3.40	63.00	21.00	4.000	9029160040000	●
M5 X 0.80	D4/D5	4.134 - 4.334	3	6.00	4.90	70.00	25.00	5.000	9029160050000	●
M6 X 1.00	D5/D6	4.917 - 5.153	3	6.00	4.90	80.00	30.00	6.000	9029160060000	●
M8 X 1.25	D5/D6	6.647 - 6.912	4	8.00	6.20	90.00	35.00	8.000	9029160080000	●
M10 X 1.50	D5/D6	8.376 - 8.676	4	10.00	8.00	100.00	39.00	10.000	9029160100000	●
M12 X 1.75	D6/D7	10.106 - 10.441	4	9.00	7.00	110.00	N/A	12.000	9029160120000	○
M16 X 2.00	D7/D8	13.835 - 14.210	4	12.00	9.00	110.00	N/A	16.000	9029160160000	○

METRIC Ni / Ni Alloys

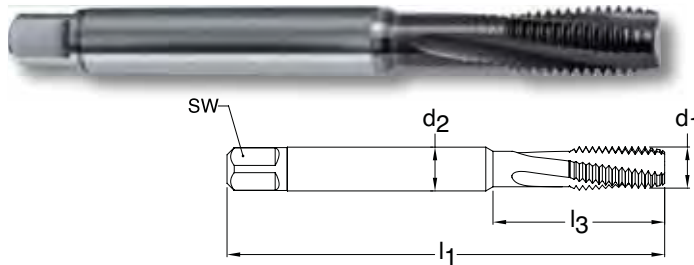

Series 2920
Standard DIN 371/376
Tool Material HSS-E PM
Spiral Flute 10° Helix
Chamfer Form C • 2-3
Class of Fit 6HX



Blind holes **TiAlN coated** **External cooling**

d1 - P	D Limits	Tap Drill Range mm	Number of Flutes	d2 mm	SW mm	l1 mm	l3 mm	Order Code	EDP Number	Stock
M3 X 0.50	D3/D4	2.459 - 2.599	3	3.50	2.70	56.00	18.00	3.000	9029200030000	●
M4 X 0.70	D4/D5	3.242 - 3.422	3	4.50	3.40	63.00	21.00	4.000	9029200040000	●
M5 X 0.80	D4/D5	4.134 - 4.334	3	6.00	4.90	70.00	25.00	5.000	9029200050000	●
M6 X 1.00	D5/D6	4.917 - 5.153	3	6.00	4.90	80.00	30.00	6.000	9029200060000	●
M8 X 1.25	D5/D6	6.647 - 6.912	3	8.00	6.20	90.00	35.00	8.000	9029200080000	●
M10 X 1.50	D5/D6	8.376 - 8.676	3	10.00	8.00	100.00	39.00	10.000	9029200100000	●
M12 X 1.75	D6/D7	10.106 - 10.441	4	9.00	7.00	110.00	N/A	12.000	9029200120000	○
M16 X 2.00	D7/D8	13.835 - 14.210	4	12.00	9.00	110.00	N/A	16.000	9029200160000	○

METRIC FINE Ni / Ni Alloys

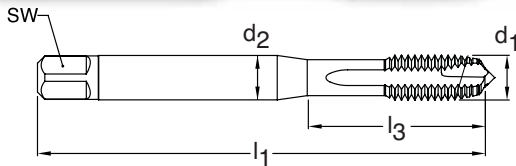

Series 2917
Standard DIN 371
Tool Material HSS-E PM
Spiral Point Straight flute
Chamfer Form B • 3.5 - 5
Class of Fit 6HX

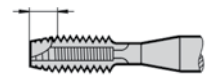

Through holes TiAlN coated External cooling

d1 - P	D Limits	Tap Drill Range mm	Number of Flutes	d2 mm	SW mm	l1 mm	l3 mm	Order Code	EDP Number	Stock
M5 X 0.50	D4/D5	4.459 - 4.599	3	6.00	4.90	70.00	25.00	5.003	9029170050030	○
M6 X 0.50	D4/D5	5.460 - 5.600	3	6.00	4.90	80.00	30.00	6.003	9029170060030	○
M6 X 0.75	D4/D5	5.188 - 5.378	3	6.00	4.90	80.00	30.00	6.004	9029170060040	●
M8 X 0.75	D4/D5	7.188 - 7.378	4	8.00	6.20	80.00	30.00	8.004	9029170080040	○
M8 X 1.00	D5/D6	6.917 - 7.153	4	8.00	6.20	90.00	35.00	8.005	9029170080050	○
M10 X 1.00	D5/D6	8.917 - 9.153	4	10.00	8.00	90.00	35.00	10.005	9029170100050	○
M10 X 1.25	D5/D6	8.647 - 8.912	4	10.00	8.00	100.00	35.00	10.006	9029170100060	●

METRIC FINE Ni / Ni Alloys

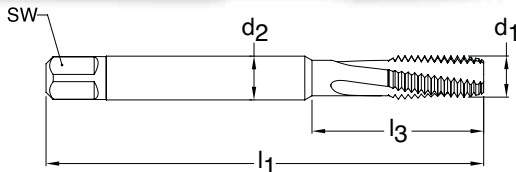

Series 2921
Standard DIN 371
Tool Material HSS-E PM
Spiral Flute 10° Helix
Chamfer Form C • 2-3
Class of Fit 6HX



Blind holes TiAlN coated External cooling

d1 - P	D Limits	Tap Drill Range mm	Number of Flutes	d2 mm	SW mm	l1 mm	l3 mm	Order Code	EDP Number	Stock
M3 X 0.35	D3/D4	2.621 - 2.721	3	3.50	2.70	56.00	18.00	3.002	9029210030020	●
M4 X 0.50	D4/D5	3.459 - 3.599	3	4.50	3.40	63.00	21.00	4.003	9029210040030	●
M5 X 0.50	D4/D5	4.459 - 4.599	3	6.00	4.90	70.00	25.00	5.003	9029210050030	●
M6 X 0.50	D4/D5	5.460 - 5.600	3	6.00	4.90	80.00	30.00	6.003	9029210060030	●
M6 X 0.75	D4/D5	5.188 - 5.378	3	6.00	4.90	80.00	30.00	6.004	9029210060040	●
M8 X 0.50	D4/D5	7.459 - 7.599	3	8.00	6.20	80.00	30.00	8.003	9029210080030	●
M8 X 0.75	D4/D5	7.188 - 7.378	3	8.00	6.20	80.00	30.00	8.004	9029210080040	●
M8 X 1.00	D5/D6	6.917 - 7.153	3	8.00	6.20	90.00	35.00	8.005	9029210080050	●
M10 X 1.00	D5/D6	8.917 - 9.153	3	10.00	8.00	90.00	35.00	10.005	9029210100050	●
M10 X 1.25	D5/D6	8.647 - 8.912	3	10.00	8.00	100.00	35.00	10.006	9029210100060	●

"Tap drill Range" given is per the Class of Fit shown per Series #
 Additional Tap Drill sizes & percent of thread engagement can be found on pages 229-237.

UNJC *Ti/Ni and Ti/Ni Alloys*

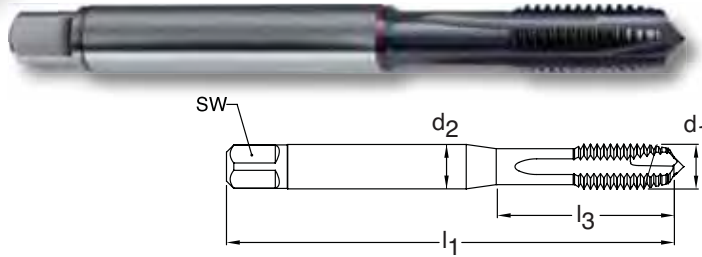

Series 1059
Standard DIN 371/376
Tool Material HSS-E PM
Spiral Point Straight flute
Chamfer Form B • 3.5 - 5
Class of Fit 3BX

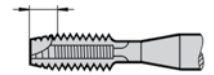

Through holes **TiCN coated** **External cooling**

d1 - P	H Limits	Tap Drill Range inch	Number of Flutes	d2 mm	SW mm	l1 mm	l3 mm	Order Code	EDP Number	Stock
6-32	H2/H3	0.108 - 0.116	3	4.00	3.00	56.00	20.00	3.505	9010590035050	●
8-32	H2/H3	0.134 - 0.142	3	4.50	3.40	63.00	21.00	4.166	9010590041660	●
10-24	H3/H4	0.149 - 0.160	3	6.00	4.90	70.00	25.00	4.826	9010590048260	●
12-24	H3/H4	0.175 - 0.185	3	6.00	4.90	80.00	30.00	5.486	9010590054860	●
1/4-20	H3/H4	0.201 - 0.212	4	7.00	5.50	80.00	30.00	6.350	9010590063500	●
5/16-18	H3/H4	0.258 - 0.269	4	8.00	6.20	90.00	35.00	7.938	9010590079380	●
3/8-16	H3/H4	0.314 - 0.325	4	10.00	8.00	100.00	39.00	9.525	9010590095250	●
7/16-14	H3/H4	0.368 - 0.379	4	8.00	6.20	100.00	N/A	11.113	9010590111130	●
1/2-13	H3/H4	0.425 - 0.437	4	9.00	7.00	110.00	N/A	12.700	9010590127000	●
5/8-11	H3/H4	0.536 - 0.547	4	12.00	9.00	110.00	N/A	15.875	9010590158750	●

UNJC *Ti / Ti Alloys*

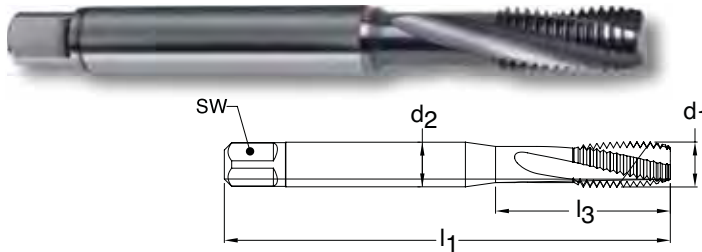

Series 1063
Standard DIN 371/376
Tool Material HSS-E PM
Spiral Flute 15° Helix
Chamfer Form C • 2-3
Class of Fit 3BX



Blind holes **TiCN coated** **External cooling**

d1 - P	H Limits	Tap Drill Range inch	Number of Flutes	d2 mm	SW mm	l1 mm	l3 mm	Order Code	EDP Number	Stock
6-32	H2/H3	0.108 - 0.116	3	4.00	3.00	56.00	20.00	3.505	9010630035050	●
8-32	H2/H3	0.134 - 0.142	3	4.50	3.40	63.00	21.00	4.166	9010630041660	●
10-24	H3/H4	0.149 - 0.160	3	6.00	4.90	70.00	25.00	4.826	9010630048260	●
12-24	H3/H4	0.175 - 0.185	3	6.00	4.90	80.00	30.00	5.486	9010630054860	●
1/4-20	H3/H4	0.201 - 0.212	3	7.00	5.50	80.00	30.00	6.350	9010630063500	●
5/16-18	H3/H4	0.258 - 0.269	3	8.00	6.20	90.00	35.00	7.938	9010630079380	●
3/8-16	H3/H4	0.314 - 0.325	3	10.00	8.00	100.00	39.00	9.525	9010630095250	●
7/16-14	H3/H4	0.368 - 0.379	4	8.00	6.20	100.00	N/A	11.113	9010630111130	●
1/2-13	H3/H4	0.425 - 0.437	4	9.00	7.00	110.00	N/A	12.700	9010630127000	●
5/8-11	H3/H4	0.536 - 0.547	4	12.00	9.00	110.00	N/A	15.875	9010630158750	●

If you have customers who are suppliers to the aerospace or military Industries, you will encounter “J” or “Controlled root radius” thread requirements.

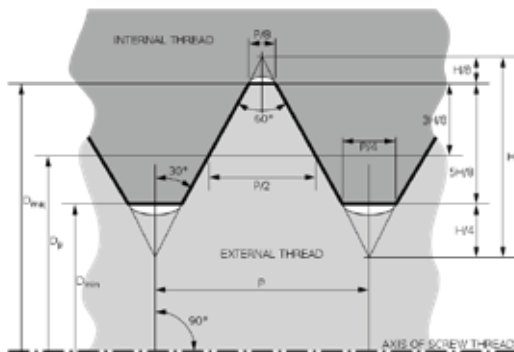

The differences between these and UNC or UNF threads are as follows:

The external thread is manufactured with radii in the root of the thread for added strength, and to extend the integrity of the threading tool.

The internal thread is manufactured to 3B class of fit tolerancing for the pitch diameter, and will need to use a larger drill for the minor diameter to accommodate the root radius in the bolt.

ANY UN-3B tap will produce a legitimate “UNJ” internal thread.

UNJF Ti/Ni and Ti/Ni Alloys

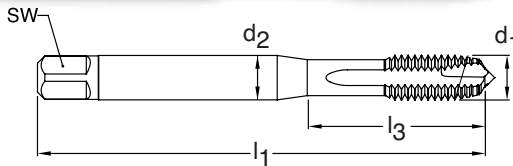

Series 1060
Standard DIN 371/376
Tool Material HSS-E PM
Spiral Point Straight flute
Chamfer Form B • 3.5 - 5
Class of Fit 3BX

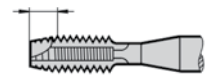

Through holes **TiCN coated** **External cooling**

d1 - P	H Limits	Tap Drill Range inch	Number of Flutes	d2 mm	SW mm	l1 mm	l3 mm	Order Code	EDP Number	Stock
6-40	H2/H3	0.114 - 0.120	3	4.00	3.00	56.00	20.00	3.505	9010600035050	●
10-32	H2/H3	0.160 - 0.168	3	6.00	4.90	70.00	25.00	4.826	9010600048260	●
12-28	H2/H3	0.181 - 0.190	3	6.00	4.90	80.00	30.00	5.486	9010600054860	●
1/4-28	H3/H4	0.215 - 0.223	4	7.00	5.50	80.00	30.00	6.350	9010600063500	●
5/16-24	H3/H4	0.272 - 0.280	4	8.00	6.20	90.00	35.00	7.938	9010600079380	●
3/8-24	H3/H4	0.334 - 0.342	4	10.00	8.00	100.00	39.00	9.525	9010600095250	●
7/16-20	H3/H4	0.389 - 0.397	4	8.00	6.20	100.00	N/A	11.113	9010600111130	●
1/2-20	H3/H4	0.451 - 0.459	4	9.00	7.00	100.00	N/A	12.700	9010600127000	●
5/8-18	H3/H4	0.571 - 0.579	4	12.00	9.00	100.00	N/A	15.875	9010600158750	●

UNJF Ti / Ti Alloys

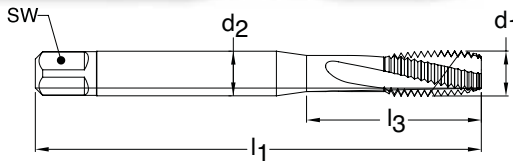

Series 1064
Standard DIN 371/376
Tool Material HSS-E PM
Spiral Flute 15° Helix
Chamfer Form C • 2-3
Class of Fit 3BX



Blind holes **TiCN coated** **External cooling**

d1 - P	H Limits	Tap Drill Range inch	Number of Flutes	d2 mm	SW mm	l1 mm	l3 mm	Order Code	EDP Number	Stock
6-40	H2/H3	0.114 - 0.120	3	4.00	3.00	56.00	20.00	3.505	9010640035050	●
8-36	H2/H3	0.137 - 0.144	3	4.50	3.40	63.00	21.00	4.166	9010640041660	●
10-32	H2/H3	0.160 - 0.168	3	6.00	4.90	70.00	25.00	4.826	9010640048260	●
12-28	H3/H4	0.181 - 0.190	3	6.00	4.90	80.00	30.00	5.486	9010640054860	●
1/4-28	H3/H4	0.215 - 0.223	3	7.00	5.50	80.00	30.00	6.350	9010640063500	●
5/16-24	H3/H4	0.272 - 0.280	3	8.00	6.20	90.00	35.00	7.938	9010640079380	●
3/8-24	H3/H4	0.334 - 0.342	3	10.00	8.00	100.00	39.00	9.525	9010640095250	●
7/16-20	H3/H4	0.389 - 0.397	4	8.00	6.20	100.00	N/A	11.113	9010640111130	●
1/2-20	H3/H4	0.451 - 0.459	4	9.00	7.00	100.00	N/A	12.700	9010640127000	●
5/8-18	H4/H5	0.571 - 0.579	4	12.00	9.00	100.00	N/A	15.875	9010640158750	●

"Tap drill Range" given is per the Class of Fit shown per Series #
 Additional Tap Drill sizes & percent of thread engagement can be found on pages 229-237.

METRIC "J" Ti/Ni and Ti/Ni Alloys

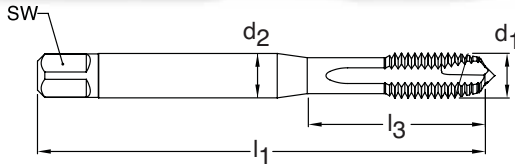

Series 1057
Standard DIN 371/376
Tool Material HSS-E PM
Spiral Point Straight flute
Chamfer Form B • 3.5 - 5
Class of Fit 4HX

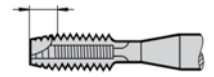

Through holes **TiCN coated** **External cooling**

d1 - P	D Limits	Tap Drill Range mm	Number of Flutes	d2 mm	SW mm	l1 mm	l3 mm	Order Code	EDP Number	Stock
M3 X 0.50	D1/D2	2.513 - 2.653	3	3.50	2.70	56.00	18.00	3.000	9010570030000	○
M4 X 0.70	D2/D3	3.318 - 3.498	3	4.50	3.40	63.00	21.00	4.000	9010570040000	○
M5 X 0.80	D2/D3	4.221 - 4.421	3	6.00	4.90	70.00	25.00	5.000	9010570050000	○
M6 X 1.00	D3/D4	5.026 - 5.216	3	6.00	4.90	80.00	30.00	6.000	9010570060000	●
M8 X 1.25	D3/D4	6.782 - 6.994	4	8.00	6.20	90.00	35.00	8.000	9010570080000	●
M10 X 1.50	D3/D4	8.539 - 8.775	4	10.00	8.00	100.00	39.00	10.000	9010570100000	●
M12 X 1.75	D4/D5	10.295 - 10.560	4	9.00	7.00	110.00	N/A	12.000	9010570120000	○
M16 X 2.00	D5/D6	14.051 - 14.351	4	12.00	9.00	110.00	N/A	16.000	9010570160000	○

METRIC "J" Ti / Ti Alloys

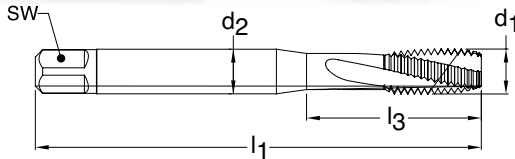

Series 1061
Standard DIN 371/376
Tool Material HSS-E PM
Spiral Flute 15° Helix
Chamfer Form C • 2-3
Class of Fit 4HX



Blind holes **TiCN coated** **External cooling**

d1 - P	D Limits	Tap Drill Range mm	Number of Flutes	d2 mm	SW mm	l1 mm	l3 mm	Order Code	EDP Number	Stock
M3 X 0.50	D1/D2	2.513 - 2.653	3	3.50	2.70	56.00	18.00	3.000	9010610030000	○
M4 X 0.70	D2/D3	3.318 - 3.498	3	4.50	3.40	63.00	21.00	4.000	9010610040000	○
M5 X 0.80	D2/D3	4.221 - 4.421	3	6.00	4.90	70.00	25.00	5.000	9010610050000	○
M6 X 1.00	D3/D4	5.026 - 5.216	3	6.00	4.90	80.00	30.00	6.000	9010610060000	●
M8 X 1.25	D3/D4	6.782 - 6.994	3	8.00	6.20	90.00	35.00	8.000	9010610080000	●
M10 X 1.50	D3/D4	8.539 - 8.775	3	10.00	8.00	100.00	39.00	10.000	9010610100000	●
M12 X 1.75	D4/D5	10.295 - 10.56	4	9.00	7.00	110.00	N/A	12.000	9010610120000	○
M16 X 2.00	D5/D6	14.051 - 14.351	4	12.00	9.00	110.00	N/A	16.000	9010610160000	○

METRIC "J" FINE *Ti/Ni and Ti/Ni Alloys*

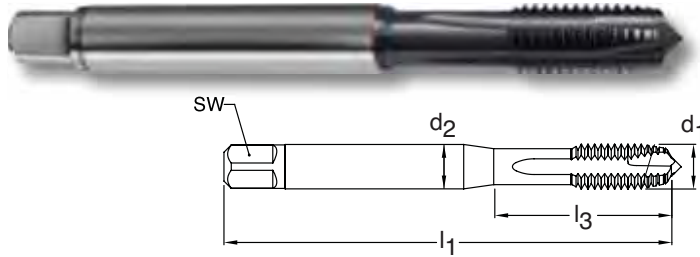

Series 1058
Standard DIN 371
Tool Material HSS-E PM
Spiral Point Straight flute
Chamfer Form B • 3.5 - 5
Class of Fit 4HX



Through holes **TiCN coated** **External cooling**

d1 - P	D Limits	Tap Drill Range mm	Number of Flutes	d2 mm	SW mm	l1 mm	l3 mm	Order Code	EDP Number	Stock
M6 X 0.50	D2/D3	5.513 - 5.625	3	6.00	4.90	80.00	30.00	6.003	9010580060030	○
M6 X 0.75	D2/D3	5.269 - 5.419	3	6.00	4.90	80.00	30.00	6.004	9010580060040	○
M8 X 1.00	D3/D4	7.026 - 7.216	4	8.00	6.20	90.00	35.00	8.005	9010580080050	○
M10 X 1.00	D3/D4	9.026 - 9.216	4	10.00	8.00	90.00	35.00	10.005	9010580100050	○
M10 X 1.25	D3/D4	8.782 - 8.994	4	10.00	8.00	100.00	39.00	10.006	9010580100060	○

METRIC "J" FINE *Ti / Ti Alloys*

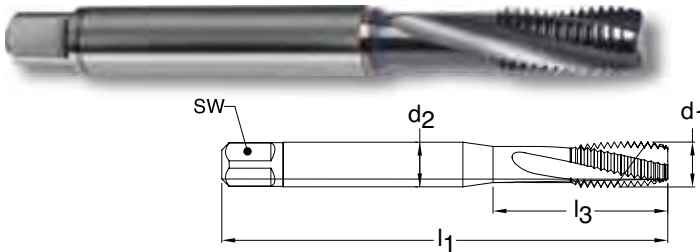

Series 1062
Standard DIN 371
Tool Material HSS-E PM
Spiral Flute 15° Helix
Chamfer Form C • 2-3
Class of Fit 4HX



Blind holes **TiCN coated** **External cooling**

d1 - P	D Limits	Tap Drill Range mm	Number of Flutes	d2 mm	SW mm	l1 mm	l3 mm	Order Code	EDP Number	Stock
M6 X 0.50	D2/D3	5.513 - 5.625	3	6.00	4.90	80.00	30.00	6.003	9010620060030	○
M6 X 0.75	D2/D3	5.269 - 5.419	3	6.00	4.90	80.00	30.00	6.004	9010620060040	○
M8 X 0.75	D2/D3	7.269 - 7.419	3	8.00	6.20	80.00	30.00	8.004	9010620080040	○
M8 X 1.00	D3/D4	7.026 - 7.216	3	8.00	6.20	90.00	35.00	8.005	9010620080050	○
M10 X 1.00	D3/D4	9.026 - 9.216	3	10.00	8.00	90.00	35.00	10.005	9010620100050	○
M10 X 1.25	D3/D4	8.782 - 8.994	3	10.00	8.00	100.00	39.00	10.006	9010620100060	○

If you have customers who are suppliers to the aerospace or military industries, you will encounter "J" or "Controlled root radius" thread requirements.

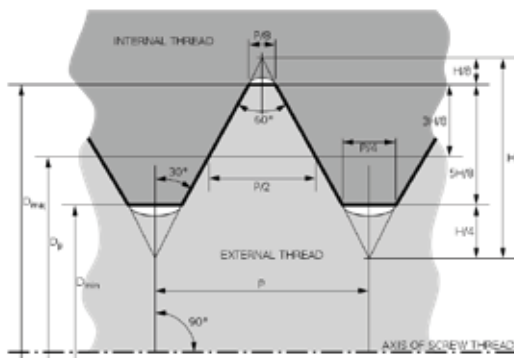

The differences between these and UNC or UNF threads are as follows:

The external thread is manufactured with radii in the root of the thread for added strength, and to extend the integrity of the threading tool.

The internal thread is manufactured to 3B class of fit tolerancing for the pitch diameter, and will need to use a larger drill for the minor diameter to accommodate the root radius in the bolt.

ANY UN-3B tap will produce a legitimate "UNJ" internal thread.

*"Tap drill Range" given is per the Class of Fit shown per Series #
 Additional Tap Drill sizes & percent of thread engagement can be found on pages 229-237.*

UNJC Ni / Ni Alloys

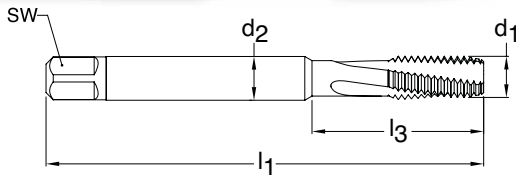

Blind holes



TiAlN coated



External cooling

Series 1067
Standard DIN 371/376
Tool Material HSS-E PM
Spiral Flute 10° Helix
Chamfer Form C • 2-3
Class of Fit 3BX



d1 - P	H Limits	Tap Drill Range inch	Number of Flutes	d2 mm	SW mm	l1 mm	l3 mm	Order Code	EDP Number	Stock
6-32	H2/H3	0.108 - 0.116	3	4.00	3.00	56.00	20.00	3.505	9010670035050	●
8-32	H2/H3	0.134 - 0.142	3	4.50	3.40	63.00	21.00	4.166	9010670041660	●
10-24	H3/H4	0.149 - 0.160	3	6.00	4.90	70.00	25.00	4.826	9010670048260	●
12-24	H3/H4	0.175 - 0.185	3	6.00	4.90	80.00	30.00	5.486	9010670054860	●
1/4-20	H3/H4	0.201 - 0.212	3	7.00	5.50	80.00	30.00	6.350	9010670063500	●
5/16-18	H3/H4	0.258 - 0.269	3	8.00	6.20	90.00	35.00	7.938	9010670079380	●
3/8-16	H3/H4	0.314 - 0.325	3	10.00	8.00	100.00	39.00	9.525	9010670095250	●
7/16-14	H3/H4	0.368 - 0.379	4	8.00	6.20	100.00	N/A	11.113	9010670111130	●
1/2-13	H3/H4	0.425 - 0.437	4	9.00	7.00	110.00	N/A	12.700	9010670127000	●
5/8-11	H3/H4	0.536 - 0.547	4	12.00	9.00	110.00	N/A	15.875	9010670158750	●

UNJF Ni / Ni Alloys

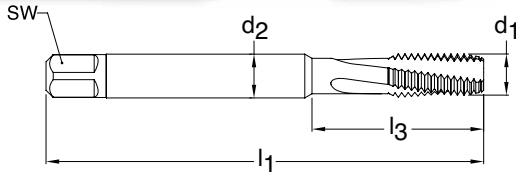

Blind holes



TiAlN coated



External cooling

Series 1068
Standard DIN 371/376
Tool Material HSS-E PM
Spiral Flute 10° Helix
Chamfer Form C • 2-3
Class of Fit 3BX



d1 - P	H Limits	Tap Drill Range inch	Number of Flutes	d2 mm	SW mm	l1 mm	l3 mm	Order Code	EDP Number	Stock
6-40	H2/H3	0.114 - 0.120	3	4.00	3.00	56.00	20.00	3.505	9010680035050	●
8-36	H2/H3	0.137 - 0.144	3	4.50	3.40	63.00	21.00	4.166	9010680041660	●
10-32	H3/H4	0.160 - 0.168	3	6.00	4.90	70.00	25.00	4.826	9010680048260	●
12-28	H3/H4	0.181 - 0.190	3	6.00	4.90	80.00	30.00	5.486	9010680054860	●
1/4-28	H3/H4	0.215 - 0.223	3	7.00	5.50	80.00	30.00	6.350	9010680063500	●
5/16-24	H3/H4	0.272 - 0.280	3	8.00	6.20	90.00	35.00	7.938	9010680079380	●
3/8-24	H3/H4	0.334 - 0.342	3	10.00	8.00	100.00	39.00	9.525	9010680095250	●
7/16-20	H3/H4	0.389 - 0.397	4	8.00	6.20	100.00	N/A	11.113	9010680111130	●
1/2-20	H3/H4	0.451 - 0.459	4	9.00	7.00	100.00	N/A	12.700	9010680127000	●
5/8-18	H3/H4	0.571 - 0.579	4	12.00	9.00	100.00	N/A	15.875	9010680158750	●

METRIC "J" Ni / Ni Alloys

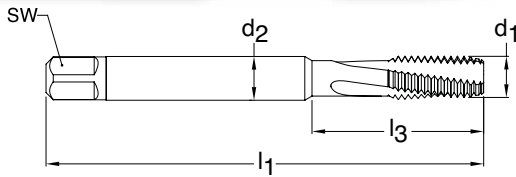

Blind holes



TiAlN coated



External cooling

Series 1065
Standard DIN 371/376
Tool Material HSS-E PM
Spiral Flute 10° Helix
Chamfer Form C • 2-3
Class of Fit 4HX



d1 - P	D Limits	Tap Drill Range mm	Number of Flutes	d2 mm	SW mm	l1 mm	l3 mm	Order Code	EDP Number	Stock
M3 X 0.50	D1/D2	2.513 - 2.653	3	3.50	2.70	56.00	18.00	3.000	9010650030000	○
M4 X 0.70	D2/D3	3.318 - 3.498	3	4.50	3.40	63.00	21.00	4.000	9010650040000	○
M5 X 0.80	D2/D3	4.221 - 4.421	3	6.00	4.90	70.00	25.00	5.000	9010650050000	○
M6 X 1.00	D3/D4	5.026 - 5.216	3	6.00	4.90	80.00	30.00	6.000	9010650060000	●
M8 X 1.25	D3/D4	6.782 - 6.994	3	8.00	6.20	90.00	35.00	8.000	9010650080000	●
M10 X 1.50	D3/D4	8.539 - 8.775	3	10.00	8.00	100.00	39.00	10.000	9010650100000	●
M12 X 1.75	D4/D5	10.295 - 10.560	4	9.00	7.00	110.00	N/A	12.000	9010650120000	○
M16 X 2.00	D5/D6	14.051 - 14.351	4	12.00	9.00	110.00	N/A	16.000	9010650160000	○

METRIC "J" FINE Ni / Ni Alloys

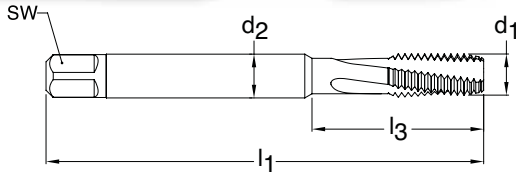

Blind holes



TiAlN coated



External cooling

Series 1066
Standard DIN 371
Tool Material HSS-E PM
Spiral Flute 10° Helix
Chamfer Form C • 2-3
Class of Fit 4HX



d1 - P	D Limits	Tap Drill Range mm	Number of Flutes	d2 mm	SW mm	l1 mm	l3 mm	Order Code	EDP Number	Stock
M6 X 0.50	D2/D3	5.513 - 5.625	3	6.00	4.90	80.00	30.00	6.003	9010660060030	○
M6 X 0.75	D2/D3	5.269 - 5.419	3	6.00	4.90	80.00	30.00	6.004	9010660060040	○
M8 X 0.50	D2/D3	7.513 - 7.625	3	8.00	6.20	80.00	30.00	8.003	9010660080030	○
M8 X 0.75	D2/D3	7.269 - 7.419	3	8.00	6.20	80.00	30.00	8.004	9010660080040	○
M8 X 1.00	D3/D4	7.026 - 7.216	3	8.00	6.20	90.00	35.00	8.005	9010660080050	○
M10 X 1.00	D3/D4	9.026 - 9.216	3	10.00	8.00	90.00	35.00	10.005	9010660100050	○
M10 X 1.25	D3/D4	8.782 - 8.994	3	10.00	8.00	100.00	39.00	10.006	9010660100060	○

"Tap drill Range" given is per the Class of Fit shown per Series #
 Additional Tap Drill sizes & percent of thread engagement can be found on pages 229-237.



WHITE RING CUT TAPS

Cast iron

Spheroidal graphite iron

Malleable cast iron

Material group	Approximate Rc	Approximate HB	Recommended SFM					
			HSS-E		HSS-E-PM		Solid carbide	
			bright finish	hard coated	bright finish	hard coated	bright finish	hard coated
Cast iron		<180	50-70	60-90	55-85	65-110	70-100	80-130
Spheroidal graphite iron	<25	<250	30-50	45-85	40-70	60-100	70-100	80-130
Malleable cast iron	<35	<320	15-35	20-40	25-45	35-55	60-110	70-120

UNC

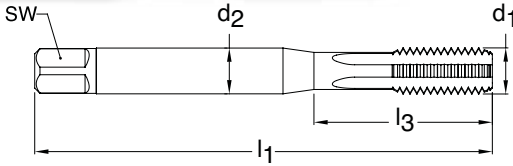

Through holes



Blind holes



FIREX® coated



External cooling

Series 3937
Standard ANSI
Tool Material HSS-E (Cobalt)
Flute Straight flute
Chamfer Form C • 2-3
Class of Fit 2B



d1 - P	H Limits	Tap Drill Range inch	Number of Flutes	d2 inch	SW inch	l1 inch	l3 inch	Order Code	EDP Number	Stock
6-32	H3/H4	0.104 - 0.114	3	0.141	0.110	2.000	0.748	3.505	9039370035050	●
8-32	H3/H4	0.130 - 0.139	3	0.168	0.131	2.130	0.827	4.166	9039370041660	●
10-24	H3/H4	0.145 - 0.155	4	0.194	0.152	2.382	0.945	4.826	9039370048260	●
12-24	H3/H4	0.171 - 0.181	4	0.220	0.165	2.382	1.024	5.486	9039370054860	●
1/4-20	H4/H5	0.196 - 0.207	4	0.255	0.191	2.500	1.181	6.350	9039370063500	●
5/16-18	H4/H5	0.252 - 0.265	4	0.318	0.238	2.721	1.377	7.938	9039370079380	●
3/8-16	H5/H6	0.307 - 0.321	4	0.381	0.286	2.941	1.456	9.525	9039370095250	●
7/16-14	H5/H6	0.360 - 0.376	4	0.323	0.242	3.161	N/A	11.113	9039370111130	●
1/2-13	H5/H6	0.417 - 0.434	4	0.367	0.275	3.382	N/A	12.700	9039370127000	●
5/8-11	H5/H6	0.527 - 0.546	4	0.480	0.360	3.811	N/A	15.875	9039370158750	●

UNF

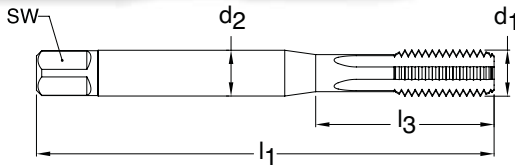

Through holes



Blind holes



FIREX® coated



External cooling

Series 3938
Standard ANSI
Tool Material HSS-E (Cobalt)
Flute Straight flute
Chamfer Form C • 2-3
Class of Fit 2B



d1 - P	H Limits	Tap Drill Range inch	Number of Flutes	d2 inch	SW inch	l1 inch	l3 inch	Order Code	EDP Number	Stock
6-40	H2/H3	0.111 - 0.119	3	0.141	0.110	2.000	0.748	3.505	9039380035050	●
8-36	H2/H3	0.134 - 0.142	3	0.168	0.131	2.130	0.827	4.166	9039380041660	●
10-32	H3/H4	0.156 - 0.164	4	0.194	0.152	2.382	0.945	4.826	9039380048260	●
12-28	H3/H4	0.177 - 0.186	4	0.220	0.165	2.382	1.024	5.486	9039380054860	●
1/4-28	H3/H4	0.211 - 0.220	4	0.255	0.191	2.500	1.181	6.350	9039380063500	●
5/16-24	H3/H4	0.267 - 0.277	4	0.318	0.238	2.721	1.377	7.938	9039380079380	●
3/8-24	H3/H4	0.330 - 0.340	4	0.381	0.286	2.941	1.456	9.525	9039380095250	●
7/16-20	H4/H5	0.383 - 0.395	4	0.323	0.242	3.161	N/A	11.113	9039380111130	●
1/2-20	H4/H5	0.446 - 0.457	4	0.367	0.275	3.382	N/A	12.700	9039380127000	●
5/8-18	H4/H5	0.565 - 0.578	4	0.480	0.360	3.811	N/A	15.875	9039380158750	●

UNC

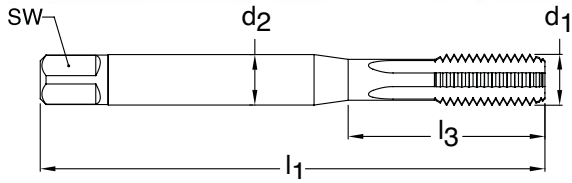

Blind holes



TiCN coated



Axial coolant

Series 4394
Standard DIN/ANSI
Tool Material HSS-E-PM
Flute Straight Flute
Chamfer Form C • 2-3
Class of Fit 2BX



d1 - P	H Limits	Tap Drill Range inch	Number of Flutes	d2 inch	SW inch	l1 inch	l3 inch	Order Code	EDP Number	Stock
10-24	H4/H5	0.145 - 0.155	3	0.194	0.152	2.756	0.945	4.826	9043940048260	●
1/4-20	H5/H6	0.196 - 0.207	3	0.255	0.191	3.150	1.181	6.350	9043940063500	●
5/16-18	H5/H6	0.252 - 0.265	3	0.318	0.238	3.543	1.377	7.938	9043940079380	●
3/8-16	H6/H7	0.307 - 0.321	3	0.381	0.286	3.937	1.456	9.525	9043940095250	●
1/2-13	H6/H7	0.417 - 0.434	3	0.367	0.275	4.331	N/A	12.700	9043940127000	●
5/8-11	H6/H7	0.527 - 0.546	4	0.480	0.360	4.331	N/A	15.875	9043940158750	●
3/4-10	H6/H7	0.642 - 0.663	4	0.590	0.442	4.921	N/A	19.050	9043940190500	●
7/8-9	H7/H8	0.755 - 0.778	5	0.697	0.523	5.512	N/A	22.225	9043940222250	●
1-8	H7/H8	0.865 - 0.890	5	0.800	0.600	6.299	N/A	25.400	9043940254000	●

Cast Iron and Abrasive Materials

UNF

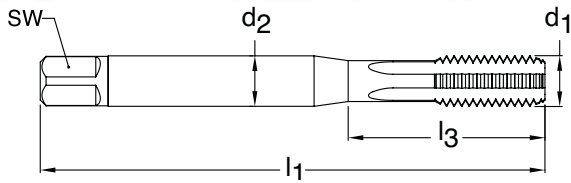

Blind holes



TiCN coated



Axial coolant

Series 4391
Standard DIN/ANSI
Tool Material HSS-E-PM
Flute Straight Flute
Chamfer Form C • 2-3
Class of Fit 2BX

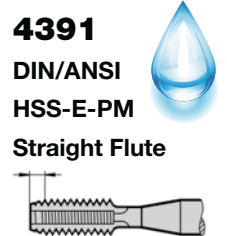

d1 - P	H Limits	Tap Drill Range inch	Number of Flutes	d2 inch	SW inch	l1 inch	l3 inch	Order Code	EDP Number	Stock
10-32	H4/H5	0.156 - 0.164	3	0.194	0.152	2.756	0.945	4.826	9043910048260	●
1/4-28	H4/H5	0.211 - 0.220	3	0.255	0.191	3.150	1.181	6.350	9043910063500	●
5/16-24	H4/H5	0.267 - 0.277	3	0.318	0.238	3.543	1.377	7.938	9043910079380	●
3/8-24	H4/H5	0.330 - 0.340	3	0.381	0.286	3.543	1.456	9.525	9043910095250	●
1/2-20	H5/H6	0.446 - 0.457	3	0.367	0.275	3.937	N/A	12.700	9043910127000	●
5/8-18	H5/H6	0.565 - 0.578	4	0.480	0.360	3.937	N/A	15.875	9043910158750	●
3/4-16	H6/H7	0.682 - 0.696	4	0.590	0.442	4.331	N/A	19.050	9043910190500	●
7/8-14	H7/H8	0.798 - 0.813	5	0.697	0.523	4.921	N/A	22.225	9043910222250	●
1-12	H7/H8	0.910 - 0.928	5	0.800	0.600	5.512	N/A	25.400	9043910254000	●

UNC

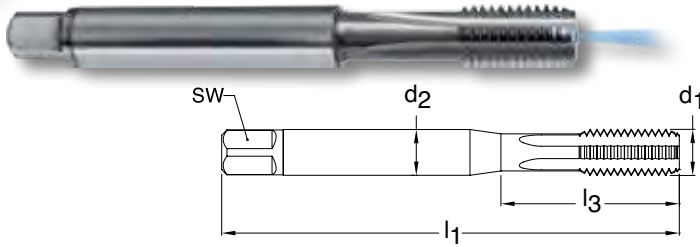

Blind holes



Bright finish



Axial coolant

Series 4118
Standard DIN/ANSI
Tool Material Carbide
Flute Straight flute
Chamfer Form C • 2-3
Class of Fit 2B



d1 - P	H Limits	Tap Drill Range inch	Number of Flutes	d2 inch	SW inch	l1 inch	l3 inch	Order Code	EDP Number	Stock
10-24	H3/H4	0.145 - 0.155	4	0.194	0.152	2.756	0.945	4.826	9041180048260	●
12-24	H3/H4	0.171 - 0.181	4	0.220	0.165	3.150	1.024	5.486	9041180054860	●
1/4-20	H4/H5	0.196 - 0.207	4	0.255	0.191	3.150	1.181	6.350	9041180063500	●
5/16-18	H4/H5	0.252 - 0.265	4	0.318	0.238	3.543	1.377	7.938	9041180079380	●
3/8-16	H5/H6	0.307 - 0.321	4	0.381	0.286	3.937	1.456	9.525	9041180095250	●
7/16-14	H5/H6	0.360 - 0.376	4	0.323	0.242	3.937	N/A	11.113	9041180111130	●
1/2-13	H5/H6	0.417 - 0.434	4	0.367	0.275	4.331	N/A	12.700	9041180127000	●
5/8-11	H5/H6	0.527 - 0.546	4	0.480	0.360	4.331	N/A	15.875	9041180158750	●
3/4-10	H5/H6	0.642 - 0.663	4	0.590	0.442	4.921	N/A	19.050	9041180190500	●

UNF

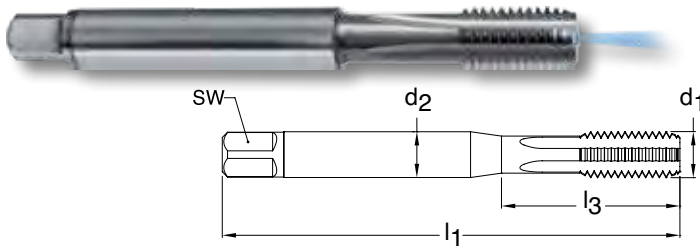

Blind holes



Bright finish



Axial coolant

Series 4119
Standard DIN/ANSI
Tool Material Carbide
Flute Straight flute
Chamfer Form C • 2-3
Class of Fit 2B



d1 - P	H Limits	Tap Drill Range inch	Number of Flutes	d2 inch	SW inch	l1 inch	l3 inch	Order Code	EDP Number	Stock
10-32	H3/H4	0.156 - 0.164	4	0.194	0.152	2.756	0.945	4.826	9041190048260	●
12-28	H3/H4	0.177 - 0.186	4	0.220	0.165	3.150	1.024	5.486	9041190054860	●
1/4-28	H3/H4	0.211 - 0.220	4	0.255	0.191	3.150	1.181	6.350	9041190063500	●
5/16-24	H3/H4	0.267 - 0.277	4	0.318	0.238	3.543	1.377	7.938	9041190079380	●
3/8-24	H3/H4	0.330 - 0.340	4	0.381	0.286	3.543	1.456	9.525	9041190095250	●
7/16-20	H4/H5	0.383 - 0.395	4	0.323	0.242	3.937	N/A	11.113	9041190111130	●
1/2-20	H4/H5	0.446 - 0.457	4	0.367	0.275	3.937	N/A	12.700	9041190127000	●
5/8-18	H4/H5	0.565 - 0.578	4	0.480	0.360	3.937	N/A	15.875	9041190158750	●
3/4-16	H5/H6	0.682 - 0.696	4	0.590	0.442	4.331	N/A	19.050	9041190190500	●

UNC

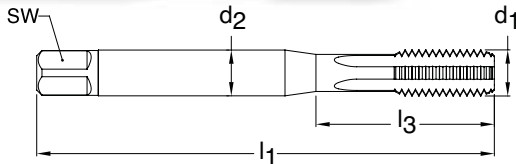

Series 1979
Standard DIN 371
Tool Material HSS-E (Cobalt)
Flute Straight flute
Chamfer Form C • 2-3
Class of Fit 2B



Through holes
 Blind holes
 Steam oxide
 External cooling

d1 - P	H Limits	Tap Drill Range inch	Number of Flutes	d2 mm	SW mm	l1 mm	l3 mm	Order Code	EDP Number	Stock
2-56	H2/H3	0.067 - 0.074	3	2.80	2.10	45.00	13.50	2.184	9019790021840	○
4-40	H2/H3	0.085 - 0.094	3	3.50	2.70	56.00	18.00	2.845	9019790028450	○
12-24	H3/H4	0.171 - 0.181	4	6.00	4.90	80.00	30.00	5.486	9019790054860	○
1/4"-20	H4/H5	0.196 - 0.207	4	7.00	5.50	80.00	30.00	6.350	9019790063500	○
5/16"-18	H4/H5	0.252 - 0.265	4	8.00	6.20	90.00	35.00	7.938	9019790079380	●
3/8"-16	H5/H6	0.307 - 0.321	4	10.00	8.00	100.00	39.00	9.525	9019790095250	●

UNC

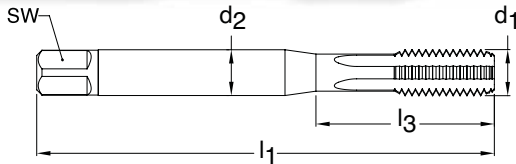

Series 1085
Standard DIN 371
Tool Material HSS-E (Cobalt)
Flute Straight flute
Chamfer Form C • 2-3
Class of Fit 2B



Blind holes
 TiAlN coated
 Axial coolant

d1 - P	H Limits	Tap Drill Range inch	Number of Flutes	d2 mm	SW mm	l1 mm	l3 mm	Order Code	EDP Number	Stock
10 -24	H3/H4	0.145 - 0.155	4	6.00	4.90	70.00	25.00	4.826	9010850048260	○
12-24	H3/H4	0.171 - 0.181	4	6.00	4.90	80.00	30.00	5.486	9010850054860	○
1/4"-20	H4/H5	0.196 - 0.207	4	7.00	5.50	80.00	30.00	6.350	9010850063500	●
5/16"-18	H4/H5	0.252 - 0.265	4	8.00	6.20	90.00	35.00	7.938	9010850079380	●
3/8"-16	H5/H6	0.307 - 0.321	4	10.00	8.00	100.00	39.00	9.525	9010850095250	●

"Tap drill Range" given is per the Class of Fit shown per Series #
 Additional Tap Drill sizes & percent of thread engagement can be found on pages 229-237

UNC

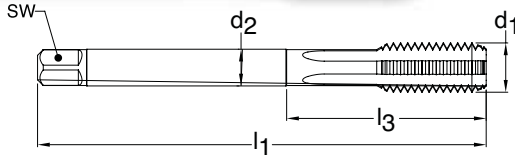

Series 1984
Standard DIN 376
Tool Material HSS-E (Cobalt)
Flute Straight flute
Chamfer Form C • 2-3
Class of Fit 2B



Through holes
 Blind holes
 Steam oxide
 External cooling

d1 - P	H Limits	Tap Drill Range inch	Number of Flutes	d2 mm	SW mm	l1 mm	l3 mm	Order Code	EDP Number	Stock
7/16-14	H5/H6	0.360 - 0.376	4	8.00	6.20	100.00	N/A	11.113	9019840111130	○
1/2-13	H5/H6	0.417 - 0.434	4	9.00	7.00	110.00	N/A	12.700	9019840127000	●
9/16-12	H5/H6	0.472 - 0.490	4	11.00	9.00	110.00	N/A	14.288	9019840142880	○
5/8-11	H5/H6	0.527 - 0.546	4	12.00	9.00	110.00	N/A	15.875	9019840158750	○
3/4-10	H5/H6	0.642 - 0.663	5	14.00	11.00	125.00	N/A	19.050	9019840190500	●

UNC

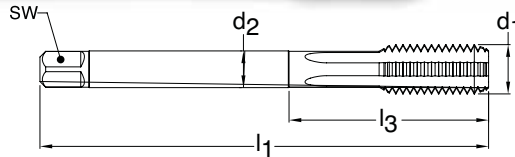

Series 1086
Standard DIN 376
Tool Material HSS-E (Cobalt)
Flute Straight flute
Chamfer Form C • 2-3
Class of Fit 2B



Blind holes
 TiAlN coated
 Axial coolant

d1 - P	H Limits	Tap Drill Range inch	Number of Flutes	d2 mm	SW mm	l1 mm	l3 mm	Order Code	EDP Number	Stock
7/16-14	H5/H6	0.360 - 0.376	4	8.00	6.20	100.00	N/A	11.113	9010860111130	●
1/2-13	H5/H6	0.417 - 0.434	4	9.00	7.00	110.00	N/A	12.700	9010860127000	●
5/8-11	H5/H6	0.527 - 0.546	4	12.00	9.00	110.00	N/A	15.875	9010860158750	●
3/4-10	H5/H6	0.642 - 0.663	5	14.00	11.00	125.00	N/A	19.050	9010860190500	●
7/8-9	H6/H7	0.755 - 0.778	5	18.00	14.50	140.00	N/A	22.225	9010860222250	●

UNF

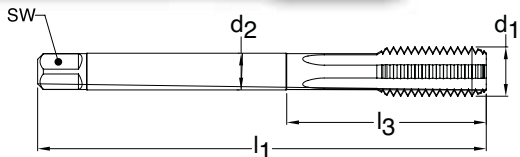

Series 1989
Standard DIN 374
Tool Material HSS-E (Cobalt)
Flute Straight flute
Chamfer Form C • 2-3
Class of Fit 2B



Through holes **Blind holes** **Steam oxide** **External cooling**

d1 - P	H Limits	Tap Drill Range inch	Number of Flutes	d2 mm	SW mm	l1 mm	l3 mm	Order Code	EDP Number	Stock
3-56	H2/H3	0.080 - 0.086	3	1.80	N/A	50.00	N/A	2.515	9019890025150	○
1/4-28	H3/H4	0.211 - 0.220	4	4.50	3.40	80.00	N/A	6.350	9019890063500	○
5/16-24	H3/H4	0.267 - 0.277	4	6.00	4.90	90.00	N/A	7.938	9019890079380	●
3/8-24	H3/H4	0.330 - 0.340	4	7.00	5.50	90.00	N/A	9.525	9019890095250	●
7/16-20	H4/H5	0.383 - 0.395	4	8.00	6.20	100.00	N/A	11.113	9019890111130	○
1/2-20	H4/H5	0.446 - 0.457	4	9.00	7.00	100.00	N/A	12.700	9019890127000	○
9/16-18	H4/H5	0.502 - 0.515	4	11.00	9.00	100.00	N/A	14.288	9019890142880	●
3/4-16	H5/H6	0.682 - 0.696	5	14.00	11.00	110.00	N/A	19.050	9019890190500	●
7/8-14	H6/H7	0.798 - 0.813	5	18.00	14.50	125.00	N/A	22.225	9019890222250	●

UNF

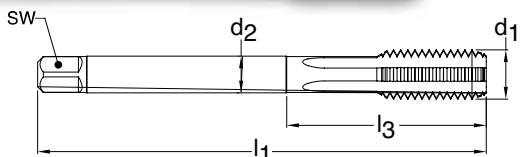

Series 1082
Standard DIN 374
Tool Material HSS-E (Cobalt)
Flute Straight flute
Chamfer Form C • 2-3
Class of Fit 2B



Blind holes **TiAlN coated** **Axial coolant**

d1 - P	H Limits	Tap Drill Range inch	Number of Flutes	d2 mm	SW mm	l1 mm	l3 mm	Order Code	EDP Number	Stock
10-32	H3/H4	0.156 - 0.164	4	3.50	2.70	70.00	N/A	4.826	9010820048260	○
12-28	H3/H4	0.177 - 0.186	4	4.00	3.00	80.00	N/A	5.486	9010820054860	○
1/4-28	H4/H5	0.211 - 0.220	4	4.50	3.40	80.00	N/A	6.350	9010820063500	●
5/16-24	H4/H5	0.267 - 0.277	4	6.00	4.90	90.00	N/A	7.938	9010820079380	●
3/8-24	H5/H6	0.330 - 0.340	4	7.00	5.50	90.00	N/A	9.525	9010820095250	●
7/16-20	H5/H6	0.383 - 0.395	4	8.00	6.20	100.00	N/A	11.113	9010820111130	●
1/2-20	H5/H6	0.446 - 0.457	4	9.00	7.00	100.00	N/A	12.700	9010820127000	●
5/8-18	H5/H6	0.565 - 0.578	4	12.00	9.00	100.00	N/A	15.875	9010820158750	●
3/4-16	H5/H6	0.682 - 0.696	5	14.00	11.00	110.00	N/A	19.050	9010820190500	●
7/8-14	H6/H7	0.798 - 0.813	5	18.00	14.50	125.00	N/A	22.225	9010820222250	●

"Tap drill Range" given is per the Class of Fit shown per Series #
 Additional Tap Drill sizes & percent of thread engagement can be found on pages 229-237

METRIC

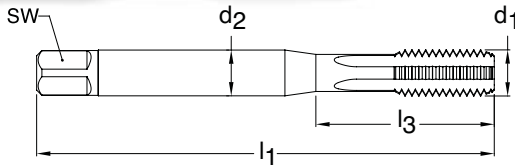

Series 3936
Standard ANSI
Tool Material HSS-E (Cobalt)
Flute Straight flute
Chamfer Form C • 2-3
Class of Fit 6HX



- Through holes**
- Blind holes**
- FIREX® coated**
- External cooling**

d1 - P	D Limits	Tap Drill Range mm	Number of Flutes	d2 inch	SW inch	l1 inch	l3 inch	Order Code	EDP Number	Stock
M3 X 0.50	D3/D4	2.459 - 2.599	3	0.141	0.110	1.941	0.709	3.000	9039360030000	●
M4 X 0.70	D4/D5	3.242 - 3.422	3	0.168	0.131	2.130	0.827	4.000	9039360040000	●
M5 X 0.80	D4/D5	4.134 - 4.334	4	0.194	0.152	2.382	0.945	5.000	9039360050000	●
M6 X 1.00	D5/D6	4.917 - 5.153	4	0.255	0.191	2.500	1.181	6.000	9039360060000	●
M8 X 1.25	D5/D6	6.647 - 6.912	4	0.318	0.238	2.721	1.377	8.000	9039360080000	●
M10 X 1.50	D5/D6	8.376 - 8.676	4	0.381	0.286	2.941	1.456	10.000	9039360100000	●
M12 X 1.75	D6/D7	10.106 - 10.441	4	0.367	0.275	3.382	N/A	12.000	9039360120000	●
M14 X 2.00	D6/D7	11.835 - 12.210	4	0.429	0.322	3.591	N/A	14.000	9039360140000	●
M16 X 2.00	D7/D8	13.835 - 14.210	4	0.480	0.360	3.811	N/A	16.000	9039360160000	●

METRIC

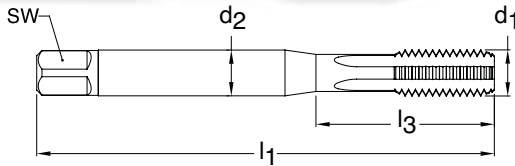

Series 1918
Standard DIN 371
Tool Material HSS-E (Cobalt)
Flute Straight flute
Chamfer Form C • 2-3
Class of Fit 6HX



Through holes
 Blind holes
 TiAlN coated
 External cooling

d1 - P	D Limits	Tap Drill Range mm	Number of Flutes	d2 mm	SW mm	l1 mm	l3 mm	Order Code	EDP Number	Stock
M4 X 0.70	D4/D5	3.242 - 3.422	3	4.50	3.40	63.00	21.00	4.000	9019180040000	○
M5 X 0.80	D4/D5	4.134 - 4.334	4	6.00	4.90	70.00	25.00	5.000	9019180050000	○
M6 X 1.00	D5/D6	4.917 - 5.153	4	6.00	4.90	80.00	30.00	6.000	9019180060000	●
M8 X 1.25	D5/D6	6.647 - 6.912	4	8.00	6.20	90.00	35.00	8.000	9019180080000	●
M10 X 1.50	D5/D6	8.376 - 8.676	4	10.00	8.00	100.00	39.00	10.000	9019180100000	●

METRIC

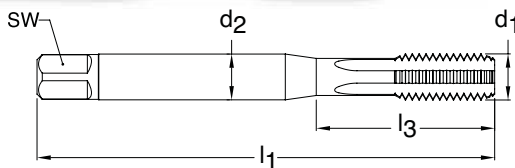

Series 318
Standard DIN 371
Tool Material HSS-E (Cobalt)
Flute Straight flute
Chamfer Form C • 2-3
Class of Fit 6HX



Blind holes
 TiAlN coated
 Axial coolant

d1 - P	D Limits	Tap Drill Range mm	Number of Flutes	d2 mm	SW mm	l1 mm	l3 mm	Order Code	EDP Number	Stock
M5 X 0.80	D4/D5	4.134 - 4.334	4	6.00	4.90	70.00	25.00	5.000	9003180050000	○
M6 X 1.00	D5/D6	4.917 - 5.153	4	6.00	4.90	80.00	30.00	6.000	9003180060000	●
M8 X 1.25	D5/D6	6.647 - 6.912	4	8.00	6.20	90.00	35.00	8.000	9003180080000	●
M10 X 1.50	D5/D6	8.376 - 8.676	4	10.00	8.00	100.00	39.00	10.000	9003180100000	●

METRIC

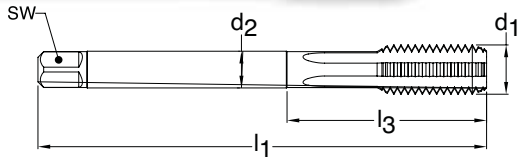

Series 1919
Standard DIN 376
Tool Material HSS-E (Cobalt)
Flute Straight flute
Chamfer Form C • 2-3
Class of Fit 6HX



- Through holes**
- Blind holes**
- TiAlN coated**
- External cooling**

d1 - P	D Limits	Tap Drill Range mm	Number of Flutes	d2 mm	SW mm	l1 mm	l3 mm	Order Code	EDP Number	Stock
M6 X 1.00	D5/D6	4.917 - 5.153	4	4.50	3.40	80.00	N/A	6.000	9019190060000	○
M8 X 1.25	D5/D6	6.647 - 6.912	4	6.00	4.90	90.00	N/A	8.000	9019190080000	●
M10 X 1.50	D5/D6	8.376 - 8.676	4	7.00	5.50	100.00	N/A	10.000	9019190100000	●
M12 X 1.75	D6/D7	10.106 - 10.441	4	9.00	7.00	110.00	N/A	12.000	9019190120000	●
M14 X 2.00	D6/D7	11.835 - 12.210	4	11.00	9.00	110.00	N/A	14.000	9019190140000	○
M16 X 2.00	D7/D8	13.835 - 14.210	4	12.00	9.00	110.00	N/A	16.000	9019190160000	○
M18 X 2.50	D7/D8	15.294 - 15.744	5	14.00	11.00	125.00	N/A	18.000	9019190180000	○
M20 X 2.50	D7/D8	17.294 - 17.744	5	16.00	12.00	140.00	N/A	20.000	9019190200000	○

METRIC

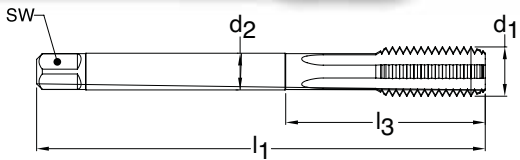

Series 319
Standard DIN 376
Tool Material HSS-E (Cobalt)
Flute Straight flute
Chamfer Form C • 2-3
Class of Fit 6HX



- Blind holes**
- TiAlN coated**
- Axial coolant**

d1 - P	D Limits	Tap Drill Range mm	Number of Flutes	d2 mm	SW mm	l1 mm	l3 mm	Order Code	EDP Number	Stock
M12 X 1.75	D6/D7	10.106 - 10.441	4	9.00	7.00	110.00	N/A	12.000	9003190120000	●
M14 X 2.00	D6/D7	11.835 - 12.210	4	11.00	9.00	110.00	N/A	14.000	9003190140000	●
M16 X 2.00	D7/D8	13.835 - 14.210	4	12.00	9.00	110.00	N/A	16.000	9003190160000	●
M18 X 2.50	D7/D8	15.294 - 15.744	5	14.00	11.00	125.00	N/A	18.000	9003190180000	○
M20 X 2.50	D7/D8	17.294 - 17.744	5	16.00	12.00	140.00	N/A	20.000	9003190200000	●

METRIC FINE

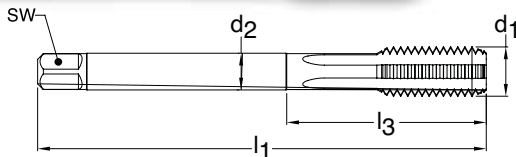

Series 169
Standard DIN 374
Tool Material HSS-E (Cobalt)
Flute Straight flute
Chamfer Form C • 2-3
Class of Fit 6HX



Through holes
 Blind holes
 TiAlN coated
 External cooling

d1 - P	D Limits	Tap Drill Range mm	Number of Flutes	d2 mm	SW mm	l1 mm	l3 mm	Order Code	EDP Number	Stock
M8 X 1.00	D5/D6	6.917 - 7.153	4	6.00	4.90	90.00	N/A	8.005	9001690080050	●
M10 X 1.00	D5/D6	8.917 - 9.153	4	7.00	5.50	90.00	N/A	10.005	9001690100050	○
M12 X 1.50	D5/D6	10.376 - 10.676	4	9.00	7.00	100.00	N/A	12.007	9001690120070	●
M14 X 1.50	D5/D6	12.376 - 12.676	4	11.00	9.00	100.00	N/A	14.007	9001690140070	●
M16 X 1.50	D5/D6	14.376 - 14.676	4	12.00	9.00	100.00	N/A	16.007	9001690160070	●
M18 X 1.50	D5/D6	16.376 - 16.676	5	14.00	11.00	110.00	N/A	18.007	9001690180070	○
M20 X 1.50	D6/D7	18.376 - 18.676	5	16.00	12.00	125.00	N/A	20.007	9001690200070	●
M22 X 1.50	D6/D7	20.376 - 20.676	5	18.00	14.50	125.00	N/A	22.007	9001690220070	○

METRIC FINE

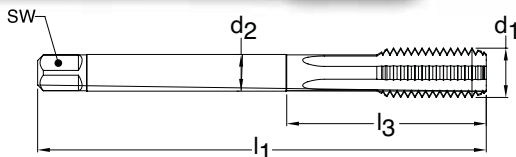

Series 347
Standard DIN 374
Tool Material HSS-E (Cobalt)
Flute Straight flute
Chamfer Form C • 2-3
Class of Fit 6HX

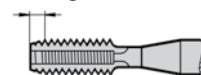

Blind holes
 TiAlN coated
 Axial coolant

d1 - P	D Limits	Tap Drill Range mm	Number of Flutes	d2 mm	SW mm	l1 mm	l3 mm	Order Code	EDP Number	Stock
M8 X 1.00	D5/D6	6.917 - 7.153	4	6.00	4.90	90.00	N/A	8.005	9003470080050	●
M10 X 1.00	D5/D6	8.917 - 9.153	4	7.00	5.50	90.00	N/A	10.005	9003470100050	○
M12 X 1.00	D5/D6	10.917 - 11.153	4	9.00	7.00	100.00	N/A	12.005	9003470120050	○
M12 X 1.50	D5/D6	10.376 - 10.676	4	9.00	7.00	100.00	N/A	12.007	9003470120070	●
M14 X 1.50	D5/D6	12.376 - 12.676	4	11.00	9.00	100.00	N/A	14.007	9003470140070	●
M16 X 1.50	D5/D6	14.376 - 14.676	4	12.00	9.00	100.00	N/A	16.007	9003470160070	●
M18 X 1.50	D5/D6	16.376 - 16.676	5	14.00	11.00	110.00	N/A	18.007	9003470180070	●
M20 X 1.50	D7/D8	18.376 - 18.676	5	16.00	12.00	125.00	N/A	20.007	9003470200070	○
M22 X 1.50	D7/D8	20.376 - 20.676	5	18.00	14.50	125.00	N/A	22.007	9003470220070	●
M24 X 1.50	D7/D8	22.376 - 22.676	5	18.00	14.50	140.00	N/A	24.007	9003470240070	○

Cast Iron and Abrasive Materials

"Tap drill Range" given is per the Class of Fit shown per Series #
 Additional Tap Drill sizes & percent of thread engagement can be found on pages 229-237

METRIC

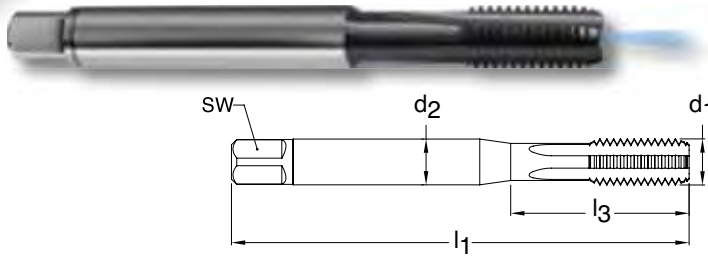

Series 302
Standard DIN 371
Tool Material HSS-E PM
Flute Straight flute
Chamfer Form C • 2-3
Class of Fit 6HX

Blind holes **TICN coated** **Axial coolant**

d1 - P	D Limits	Tap Drill Range mm	Number of Flutes	d2 mm	SW mm	l1 mm	l3 mm	Order Code	EDP Number	Stock
M5 X 0.80	D4/D5	4.134 - 4.334	3	6.00	4.90	70.00	25.00	5.000	9003020050000	○
M6 X 1.00	D5/D6	4.917 - 5.153	3	6.00	4.90	80.00	30.00	6.000	9003020060000	●
M8 X 1.25	D5/D6	6.647 - 6.912	3	8.00	6.20	90.00	35.00	8.000	9003020080000	●
M10 X 1.50	D5/D6	8.376 - 8.676	3	10.00	8.00	100.00	39.00	10.000	9003020100000	●

METRIC

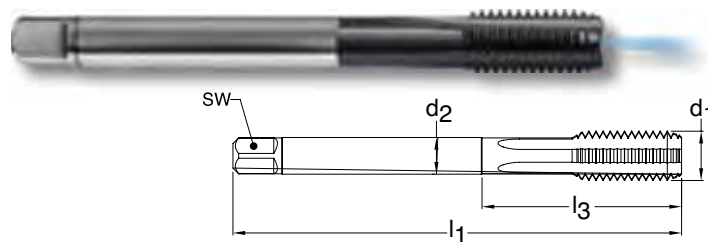

Series 297
Standard DIN 376
Tool Material HSS-E PM
Flute Straight flute
Chamfer Form C • 2-3
Class of Fit 6HX

Blind holes **TICN coated** **Axial coolant**

d1 - P	D Limits	Tap Drill Range mm	Number of Flutes	d2 mm	SW mm	l1 mm	l3 mm	Order Code	EDP Number	Stock
M10 X 1.50	D5/D6	8.376 - 8.676	3	7.00	5.50	100.00	N/A	10.000	9002970100000	●
M12 X 1.75	D6/D7	10.106 - 10.441	3	9.00	7.00	110.00	N/A	12.000	9002970120000	●
M14 X 2.00	D6/D7	11.835 - 12.210	3	11.00	9.00	110.00	N/A	14.000	9002970140000	○

METRIC FINE

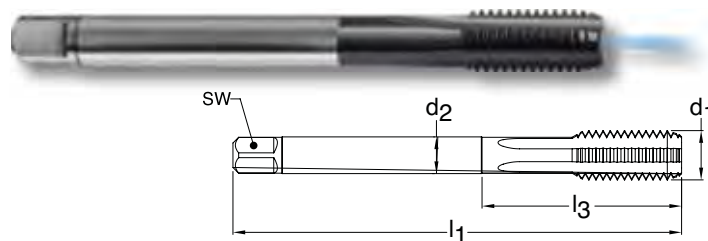

Series 1090
Standard DIN 374
Tool Material HSS-E PM
Flute Straight flute
Chamfer Form C • 2-3
Class of Fit 6HX

Blind holes **TICN coated** **Axial coolant**

d1 - P	D Limits	Tap Drill Range mm	Number of Flutes	d2 mm	SW mm	l1 mm	l3 mm	Order Code	EDP Number	Stock
M5 X 0.50	D4/D5	4.459 - 4.599	3	3.50	2.70	70.00	N/A	5.003	90 0050030	○
M6 X 0.50	D5/D6	5.460 - 5.600	3	4.50	3.40	80.00	N/A	6.003	9010900060030	○
M6 X 0.75	D5/D6	5.188 - 5.378	3	4.50	3.40	80.00	N/A	6.004	9010900060040	○
M8 X 0.75	D5/D6	7.188 - 7.378	3	6.00	4.90	80.00	N/A	8.004	9010900080040	○
M8 X 1.00	D5/D6	6.917 - 7.153	3	6.00	4.90	90.00	N/A	8.005	9010900080050	●
M10 X 1.00	D5/D6	8.917 - 9.153	3	7.00	5.50	90.00	N/A	10.005	9010900100050	●
M10 X 1.25	D5/D6	8.647 - 8.912	3	7.00	5.50	100.00	N/A	10.006	9010900100060	○
M12 X 1.00	D5/D6	10.917 - 11.153	3	9.00	7.00	100.00	N/A	12.005	9010900120050	●
M12 X 1.25	D5/D6	10.647 - 10.912	3	9.00	7.00	100.00	N/A	12.006	9010900120060	●
M12 X 1.50	D5/D6	10.376 - 10.676	3	9.00	7.00	100.00	N/A	12.007	9010900120070	●
M14 X 1.50	D5/D6	12.376 - 12.676	3	11.00	9.00	100.00	N/A	14.007	9010900140070	●
M16 X 1.50	D5/D6	14.376 - 14.676	4	12.00	9.00	100.00	N/A	16.007	9010900160070	○

METRIC

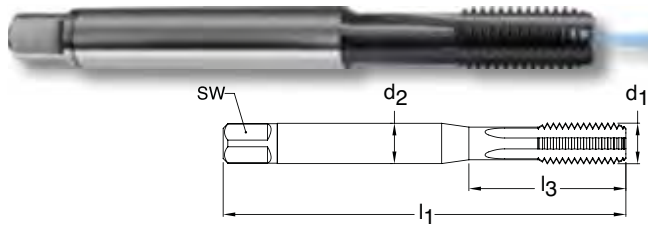

Blind holes



TiCN coated



Axial coolant

Series 1091
Standard DIN 371
Tool Material HSS-E PM
Flute Straight flute

Chamfer Form E • 1.5-2

Class of Fit 6HX



d1 - P	D Limits	Tap Drill Range mm	Number of Flutes	d2 mm	SW mm	l1 mm	l3 mm	Order Code	EDP Number	Stock
M5 X 0.80	D4/D5	4.134 - 4.334	3	6.00	4.90	70.00	25.00	5.000	9010910050000	○
M6 X 1.00	D5/D6	4.917 - 5.153	3	6.00	4.90	80.00	30.00	6.000	9010910060000	●
M8 X 1.25	D5/D6	6.647 - 6.912	3	8.00	6.20	90.00	35.00	8.000	9010910080000	●
M10 X 1.50	D5/D6	8.376 - 8.676	3	10.00	8.00	100.00	39.00	10.000	9010910100000	●

METRIC

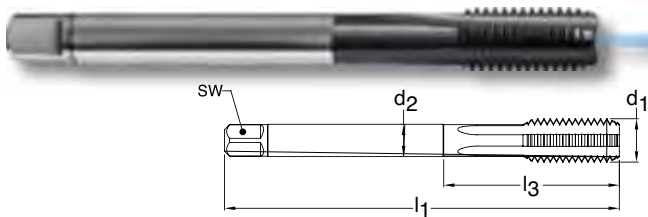

Blind holes



TiCN coated



Axial coolant

Series 4165
Standard DIN 376
Tool Material HSS-E PM
Flute Straight flute

Chamfer Form E • 1.5-2

Class of Fit 6HX



d1 - P	D Limits	Tap Drill Range mm	Number of Flutes	d2 mm	SW mm	l1 mm	l3 mm	Order Code	EDP Number	Stock
M10 X 1.50	D5/D6	8.376 - 8.676	3	7.00	5.50	100.00	N/A	10.000	9041650100000	○
M12 X 1.75	D6/D7	10.106 - 10.441	3	9.00	7.00	110.00	N/A	12.000	9041650120000	○
M16 X 2.00	D7/D8	13.835 - 14.210	4	12.00	9.00	110.00	N/A	16.000	9041650160000	○
M20 X 2.50	D7/D8	17.294 - 17.744	4	16.00	12.00	140.00	N/A	20.000	9041650200000	○

METRIC FINE

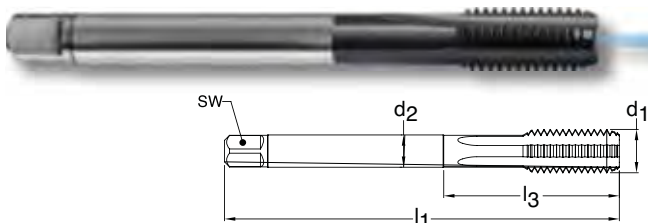

Blind holes



TiCN coated



Axial coolant

Series 1007
Standard DIN 374
Tool Material HSS-E PM
Flute Straight flute

Chamfer Form E • 1.5-2

Class of Fit 6HX



d1 - P	D Limits	Tap Drill Range mm	Number of Flutes	d2 mm	SW mm	l1 mm	l3 mm	Order Code	EDP Number	Stock
M5 X 0.50	D4/D5	4.459 - 4.599	3	3.50	2.70	70.00	N/A	5.003	9010070050030	○
M6 X 0.50	D5/D6	5.460 - 5.600	3	4.50	3.40	80.00	N/A	6.003	9010070060030	○
M6 X 0.75	D5/D6	5.188 - 5.378	3	4.50	3.40	80.00	N/A	6.004	9010070060040	○
M8 X 0.75	D5/D6	7.188 - 7.378	3	6.00	4.90	80.00	N/A	8.004	9010070080040	○
M8 X 1.00	D5/D6	6.917 - 7.153	3	6.00	4.90	90.00	N/A	8.005	9010070080050	●
M9 X 1.00	D5/D6	7.917 - 8.153	3	7.00	5.50	90.00	N/A	9.005	9010070090050	●
M10 X 1.00	D5/D6	8.917 - 9.153	3	7.00	5.50	90.00	N/A	10.005	9010070100050	●
M10 X 1.25	D5/D6	8.647 - 8.912	3	7.00	5.50	100.00	N/A	10.006	9010070100060	●
M12 X 1.00	D5/D6	10.917 - 11.153	3	9.00	7.00	100.00	N/A	12.005	9010070120050	○
M12 X 1.25	D5/D6	10.647 - 10.912	3	9.00	7.00	100.00	N/A	12.006	9010070120060	●
M12 X 1.50	D5/D6	10.376 - 10.676	3	9.00	7.00	100.00	N/A	12.007	9010070120070	●
M14 X 1.00	D5/D6	12.917 - 13.153	3	11.00	9.00	100.00	N/A	14.005	9010070140050	○
M14 X 1.25	D5/D6	12.647 - 12.912	3	11.00	9.00	100.00	N/A	14.006	9010070140060	●
M14 X 1.50	D5/D6	12.376 - 12.676	3	11.00	9.00	100.00	N/A	14.007	9010070140070	●
M16 X 1.00	D5/D6	14.917 - 15.153	4	12.00	9.00	100.00	N/A	16.005	9010070160050	○
M16 X 1.50	D5/D6	14.376 - 14.676	4	12.00	9.00	100.00	N/A	16.007	9010070160070	●

"Tap drill Range" given is per the Class of Fit shown per Series #
 Additional Tap Drill sizes & percent of thread engagement can be found on pages 229-237

METRIC

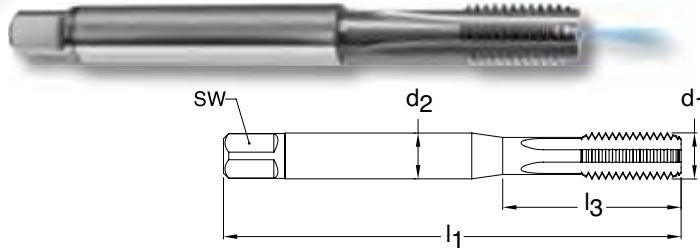

Series 1008
Standard DIN 371
Tool Material Carbide
Flute Straight flute
Chamfer Form E • 1.5-2
Class of Fit 6HX



Blind holes **Bright finish** **Axial coolant**

d1 - P	D Limits	Tap Drill Range mm	Number of Flutes	d2 mm	SW mm	l1 mm	l3 mm	Order Code	EDP Number	Stock
*M3 X 0.50	D3/D4	2.459 - 2.599	3	3.50	2.70	56.00	18.00	3.000	9010080030000	○
*M4 X 0.70	D4/D5	3.242 - 3.422	3	4.50	3.40	63.00	21.00	4.000	9010080040000	○
M5 X 0.80	D4/D5	4.134 - 4.334	4	6.00	4.90	70.00	25.00	5.000	9010080050000	○
M6 X 1.00	D5/D6	4.917 - 5.153	4	6.00	4.90	80.00	30.00	6.000	9010080060000	●
M8 X 1.25	D5/D6	6.647 - 6.912	4	8.00	6.20	90.00	35.00	8.000	9010080080000	●
M10 X 1.50	D5/D6	8.376 - 8.676	4	10.00	8.00	100.00	39.00	10.000	9010080100000	●

* M3, M4 no axial coolant

METRIC FINE

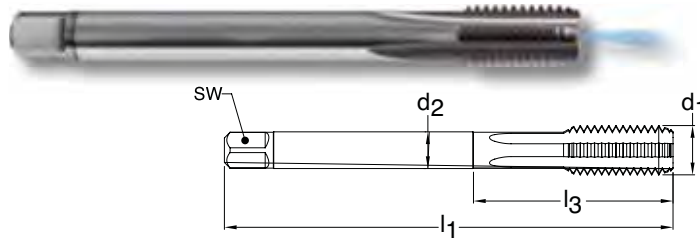

Series 1009
Standard DIN 371/374
Tool Material Carbide
Flute Straight flute
Chamfer Form E • 1.5-2
Class of Fit 6HX



Blind holes **Bright finish** **Axial coolant**

d1 - P	D Limits	Tap Drill Range mm	Number of Flutes	d2 mm	SW mm	l1 mm	l3 mm	Order Code	EDP Number	Stock
M10 X 1.00	D5/D6	8.917 - 9.153	4	10.00	8.00	90.00	35.00	10.005	9010090100050	○
M12 X 1.00	D6/D7	10.917 - 11.153	4	9.00	7.00	100.00	N/A	12.005	9010090120050	○
M12 X 1.50	D6/D7	10.376 - 10.676	4	9.00	7.00	100.00	N/A	12.007	9010090120070	○
M14 X 1.50	D6/D7	12.376 - 12.676	4	11.00	9.00	100.00	N/A	14.007	9010090140070	○
M16 X 1.50	D6/D7	14.376 - 14.676	4	12.00	9.00	100.00	N/A	16.007	9010090160070	○

METRIC

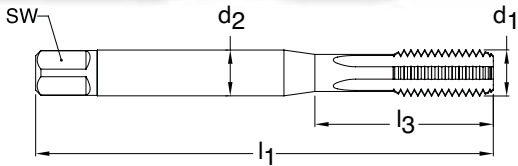

Series 969
Standard DIN 371
Tool Material Carbide
Flute Straight flute
Chamfer Form C • 2-3
Class of Fit 6HX



Blind holes **Bright finish** **Axial coolant**

d1 - P	D Limits	Tap Drill Range mm	Number of Flutes	d2 mm	SW mm	l1 mm	l3 mm	Order Code	EDP Number	Stock
* M3 X 0.50	D3/D4	2.459 - 2.599	3	3.50	2.70	56.00	18.00	3.000	9009690030000	○
* M4 X 0.70	D4/D5	3.242 - 3.422	3	4.50	3.40	63.00	21.00	4.000	9009690040000	●
M5 X 0.80	D4/D5	4.134 - 4.334	4	6.00	4.90	70.00	25.00	5.000	9009690050000	●
M6 X 1.00	D5/D6	4.917 - 5.153	4	6.00	4.90	80.00	30.00	6.000	9009690060000	●
M8 X 1.25	D5/D6	6.647 - 6.912	4	8.00	6.20	90.00	35.00	8.000	9009690080000	●
M10 X 1.50	D5/D6	8.376 - 8.676	4	10.00	8.00	100.00	39.00	10.000	9009690100000	●

* M3, M4 no axial coolant

METRIC

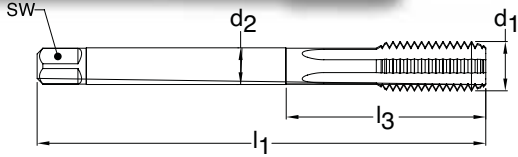

Series 1883
Standard DIN 376
Tool Material Carbide
Flute Straight flute
Chamfer Form C • 2-3
Class of Fit 6HX



Blind holes **Bright finish** **Axial coolant**

d1 - P	D Limits	Tap Drill Range mm	Number of Flutes	d2 mm	SW mm	l1 mm	l3 mm	Order Code	EDP Number	Stock
M12 X 1.75	D6/D7	10.106 - 10.441	4	9.00	7.00	110.00	N/A	12.000	9018830120000	●
M14 X 2.00	D6/D7	11.835 - 12.210	4	11.00	9.00	110.00	N/A	14.000	9018830140000	●
M16 X 2.00	D7/D8	13.835 - 14.210	4	12.00	9.00	110.00	N/A	16.000	9018830160000	●
M18 X 2.50	D7/D8	15.294 - 15.744	4	14.00	11.00	125.00	N/A	18.000	9018830180000	○
M20 X 2.50	D7/D8	17.294 - 17.744	4	16.00	12.00	140.00	N/A	20.000	9018830200000	●

METRIC FINE

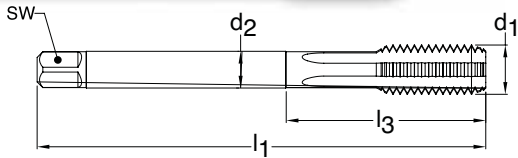

Series 974
Standard DIN 374
Tool Material Carbide
Flute Straight flute
Chamfer Form C • 2-3
Class of Fit 6HX



Blind holes **Bright finish** **Axial coolant**

d1 - P	D Limits	Tap Drill Range mm	Number of Flutes	d2 mm	SW mm	l1 mm	l3 mm	Order Code	EDP Number	Stock
M12 X 1.50	D5/D6	10.376 - 10.676	4	9.00	7.00	100.00	N/A	12.007	9009740120070	○
M14 X 1.50	D5/D6	12.376 - 12.676	4	11.00	9.00	100.00	N/A	14.007	9009740140070	○
M16 X 1.50	D5/D6	14.376 - 14.676	4	12.00	9.00	100.00	N/A	16.007	9009740160070	○
M18 X 1.50	D5/D6	16.376 - 16.676	4	14.00	11.00	110.00	N/A	18.007	9009740180070	○
M20 X 1.50	D6/D7	18.376 - 18.676	4	16.00	12.00	125.00	N/A	20.007	9009740200070	○

"Tap drill Range" given is per the Class of Fit shown per Series #
 Additional Tap Drill sizes & percent of thread engagement can be found on pages 229-237

METRIC

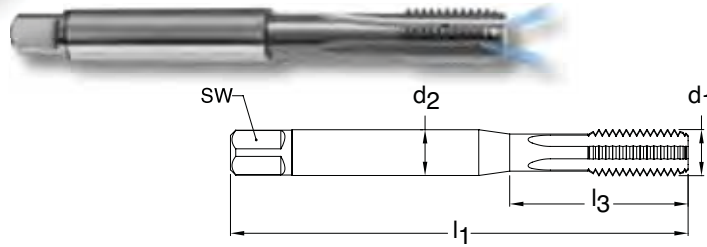

Series 1858
Standard DIN 371
Tool Material Carbide
Flute Straight flute
Chamfer Form C • 2-3
Class of Fit 6HX



Through holes
 Blind holes
 Bright finish
 Radial coolant

d1 - P	D Limits	Tap Drill Range mm	Number of Flutes	d2 mm	SW mm	l1 mm	l3 mm	Order Code	EDP Number	Stock
M5 X 0.80	D4/D5	4.134 - 4.334	4	6.00	4.90	70.00	25.00	5.000	9018580050000	●
M6 X 1.00	D5/D6	4.917 - 5.153	4	6.00	4.90	80.00	30.00	6.000	9018580060000	●
M8 X 1.25	D5/D6	6.647 - 6.912	4	8.00	6.20	90.00	35.00	8.000	9018580080000	●
M10 X 1.50	D5/D6	8.376 - 8.676	4	10.00	8.00	100.00	39.00	10.000	9018580100000	●

METRIC

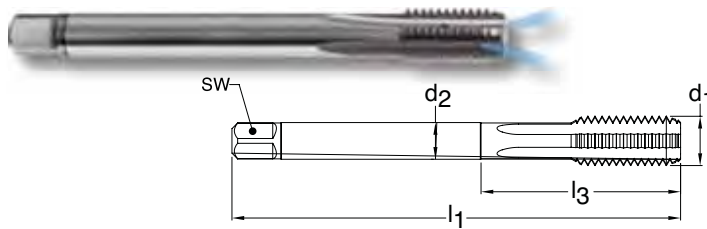

Series 1859
Standard DIN 376
Tool Material Carbide
Flute Straight flute
Chamfer Form C • 2-3
Class of Fit 6HX



Through holes
 Blind holes
 Bright finish
 Radial coolant

d1 - P	D Limits	Tap Drill Range mm	Number of Flutes	d2 mm	SW mm	l1 mm	l3 mm	Order Code	EDP Number	Stock
M12 X 1.75	D6/D7	10.106 - 10.441	4	9.00	7.00	110.00	N/A	12.000	9018590120000	●
M14 X 2.00	D6/D7	11.835 - 12.210	4	11.00	9.00	110.00	N/A	14.000	9018590140000	○
M16 X 2.00	D7/D8	13.835 - 14.210	4	12.00	9.00	110.00	N/A	16.000	9018590160000	●
M18 X 2.50	D7/D8	15.294 - 15.744	4	14.00	11.00	125.00	N/A	18.000	9018590180000	○
M20 X 2.50	D7/D8	17.294 - 17.744	4	16.00	12.00	140.00	N/A	20.000	9018590200000	●

METRIC FINE

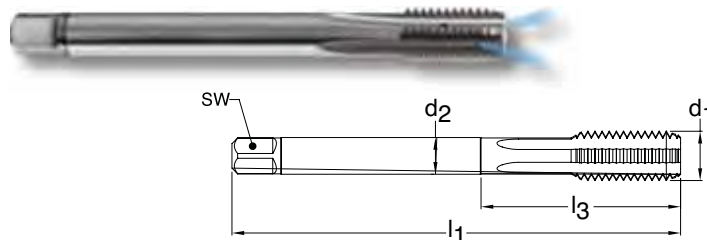

Series 1860
Standard DIN 374
Tool Material Carbide
Flute Straight flute
Chamfer Form C • 2-3
Class of Fit 6HX



Through holes
 Blind holes
 Bright finish
 Radial coolant

d1 - P	D Limits	Tap Drill Range mm	Number of Flutes	d2 mm	SW mm	l1 mm	l3 mm	Order Code	EDP Number	Stock
M12 X 1.50	D5/D6	10.376 - 10.676	4	9.00	7.00	100.00	40.00	12.007	9018600120070	●
M14 X 1.50	D5/D6	12.376 - 12.676	4	11.00	9.00	100.00	40.00	14.007	9018600140070	●
M16 X 1.50	D5/D6	14.376 - 14.676	4	12.00	9.00	100.00	40.00	16.007	9018600160070	●
M18 X 1.50	D5/D6	16.376 - 16.676	4	14.00	11.00	110.00	41.00	18.007	9018600180070	○
M20 X 1.50	D7/D8	18.376 - 18.676	4	16.00	12.00	125.00	41.00	20.007	9018600200070	○

METRIC

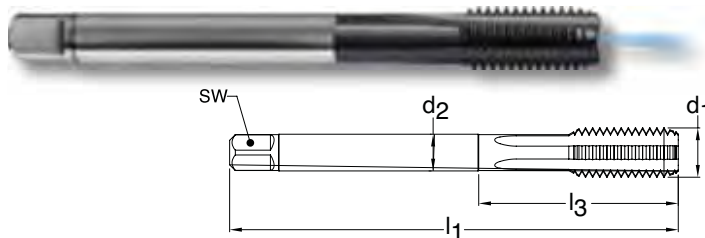

Series 778
Standard DIN 376
Tool Material HSS-E (Cobalt)
Flute Straight flute
Chamfer Form C • 2-3
Class of Fit 6HX



Blind holes



TiCN coated



Axial coolant

d1 - P	D Limits	Tap Drill Range mm	Number of Flutes	d2 mm	SW mm	l1 mm	l3 mm	Order Code	EDP Number	Stock
M16 X 2.00	D7/D8	13.835 - 14.210	4	12.00	9.00	110.00	N/A	16.000	9007780160000	●
M20 X 2.50	D7/D8	17.294 - 17.744	4	16.00	12.00	140.00	N/A	20.000	9007780200000	○
M24 X 3.00	D8/D9	20.752 - 21.252	5	18.00	14.50	160.00	N/A	24.000	9007780240000	●
M27 X 3.00	D8/D9	23.752 - 24.252	5	20.00	16.00	160.00	N/A	27.000	9007780270000	○
M30 X 3.50	D9/D10	26.211 - 26.771	5	22.00	18.00	180.00	N/A	30.000	9007780300000	●
M33 X 3.50	D9/D10	29.211 - 29.711	6	25.00	20.00	180.00	N/A	33.000	9007780330000	○
M36 X 4.00	D9/D10	31.670 - 32.270	6	28.00	22.00	200.00	N/A	36.000	9007780360000	○
M39 X 4.00	D10/D11	34.690 - 35.780	6	32.00	24.00	200.00	N/A	39.000	9007780390000	○

METRIC - EXTENDED LENGTH

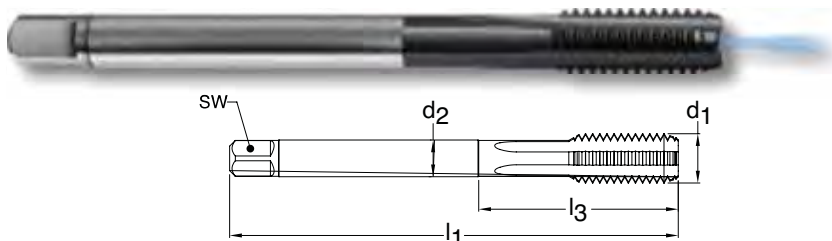

Series 779
Standard ~DIN 376
Tool Material HSS-E (Cobalt)
Flute Straight flute
Chamfer Form C • 2-3
Class of Fit 6HX

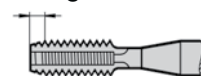

Blind holes



TiCN coated



Axial coolant

d1 - P	D Limits	Tap Drill Range mm	Number of Flutes	d2 mm	SW mm	l1 mm	l3 mm	Order Code	EDP Number	Stock
M16 X 2.00	D7/D8	13.835 - 14.210	3	12.00	9.00	160.00	N/A	16.000	9007790160000	○
M20 X 2.50	D7/D8	17.294 - 17.744	3	16.00	12.00	180.00	N/A	20.000	9007790200000	○
M24 X 3.00	D8/D9	20.752 - 21.252	4	18.00	14.50	200.00	N/A	24.000	9007790240000	○
M27 X 3.00	D8/D9	23.752 - 24.252	4	20.00	16.00	225.00	N/A	27.000	9007790270000	○
M30 X 3.50	D9/D10	26.211 - 26.711	4	22.00	18.00	250.00	N/A	30.000	9007790300000	○
M33 X 3.50	D9/D10	29.211 - 29.711	4	25.00	20.00	275.00	N/A	33.000	9007790330000	○
M36 X 4.00	D9/D10	31.670 - 32.270	5	28.00	22.00	300.00	N/A	36.000	9007790360000	○
M39 X 4.00	D10/D11	34.690 - 35.780	5	32.00	24.00	325.00	N/A	39.000	9007790390000	○



BLACK RING CUT TAPS

Aluminum

Aluminum Alloys

Material group	Approximate Rc	Approximate HB	Recommended SFM					
			HSS-E		HSS-E-PM		Solid carbide	
			bright finish	hard coated	bright finish	hard coated	bright finish	hard coated
Aluminium and Al-alloys	SILICON CONTENT	WROUGHT ALUMINUM						
Al cast alloys	< 6%	n/a	30-50	50-75	—	—	80-140	—
	6-10%	n/a	25-35	40-50	—	—	80-140	—
Al wrought alloys	>10%	n/a	-	25-35	—	—	60-130	—
	n/a	30-80	50-65	65-100	—	—	—	—
	n/a	75-150	35-60	50-65	—	—	—	—

UNC

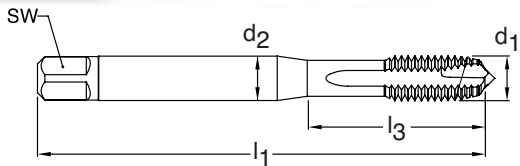

Series 3925
Standard ANSI
Tool Material HSS-E (Cobalt)
Spiral Point Straight flute
Chamfer Form B • 3.5 - 5
Class of Fit 2B



Through holes **Bright Finish** **External cooling**

d1 - P	H Limits	Tap Drill Range inch	Number of Flutes	d2 inch	SW inch	l1 inch	l3 inch	Order Code	EDP Number	Stock
4-40	H2/H3	0.085 - 0.094	2	0.141	0.110	2.205	0.709	2.845	9039250028450	●
5-40	H2/H3	0.098 - 0.106	2	0.141	0.110	2.205	0.709	3.175	9039250031750	●
6-32	H3/H4	0.104 - 0.114	3	0.141	0.110	2.000	0.748	3.505	9039250035050	●
8-32	H3/H4	0.130 - 0.139	3	0.168	0.131	2.130	0.827	4.166	9039250041660	●
10-24	H3/H4	0.145 - 0.155	3	0.194	0.152	2.382	0.945	4.826	9039250048260	●
12-24	H3/H4	0.171 - 0.181	3	0.220	0.165	2.382	1.024	5.486	9039250054860	●
1/4-20	H4/H5	0.196 - 0.207	3	0.255	0.191	2.500	1.181	6.350	9039250063500	●
5/16-18	H4/H5	0.252 - 0.265	3	0.318	0.238	2.721	1.377	7.938	9039250079380	●
3/8-16	H5/H6	0.307 - 0.321	3	0.381	0.286	2.941	1.456	9.525	9039250095250	●
7/16-14	H5/H6	0.360 - 0.376	3	0.323	0.242	3.161	N/A	11.113	9039250111130	●
1/2-13	H5/H6	0.417 - 0.434	3	0.367	0.275	3.382	N/A	12.700	9039250127000	●
5/8-11	H5/H6	0.527 - 0.546	3	0.480	0.360	3.811	N/A	15.875	9039250158750	●

UNC

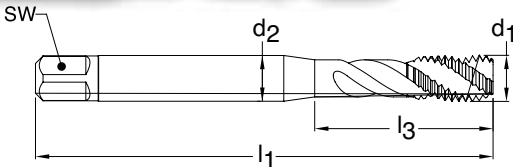

Series 3931
Standard ANSI
Tool Material HSS-E (Cobalt)
Spiral Flute 45° Helix
Chamfer Form C • 2-3
Class of Fit 2B

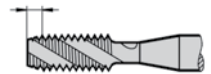

Blind holes **Bright finish** **External cooling**

d1 - P	H Limits	Tap Drill Range inch	Number of Flutes	d2 inch	SW inch	l1 inch	l3 inch	Order Code	EDP Number	Stock
4-40	H2/H3	0.085 - 0.094	2	0.141	0.110	2.205	0.709	2.845	9039310028450	●
5-40	H2/H3	0.098 - 0.106	2	0.141	0.110	2.205	0.709	3.175	9039310031750	●
6-32	H3/H4	0.104 - 0.114	2	0.141	0.110	2.000	0.748	3.505	9039310035050	●
8-32	H3/H4	0.130 - 0.139	2	0.168	0.131	2.130	0.827	4.166	9039310041660	●
10-24	H3/H4	0.145 - 0.155	2	0.194	0.152	2.382	0.945	4.826	9039310048260	●
12-24	H3/H4	0.171 - 0.181	2	0.220	0.165	2.382	1.024	5.486	9039310054860	●
1/4-20	H4/H5	0.196 - 0.207	2	0.255	0.191	2.500	1.181	6.350	9039310063500	●
5/16-18	H4/H5	0.252 - 0.265	2	0.318	0.238	2.721	1.377	7.938	9039310079380	●
3/8-16	H5/H6	0.307 - 0.321	2	0.381	0.286	2.941	1.456	9.525	9039310095250	●
7/16-14	H5/H6	0.360 - 0.376	2	0.323	0.242	3.161	N/A	11.113	9039310111130	●
1/2-13	H5/H6	0.417 - 0.434	2	0.367	0.275	3.382	N/A	12.700	9039310127000	●
5/8-11	H5/H6	0.527 - 0.546	3	0.480	0.360	3.811	N/A	15.875	9039310158750	●

UNF

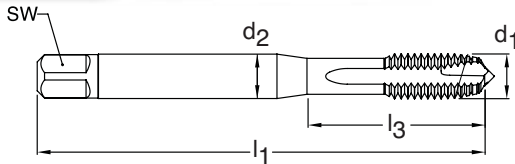

Series 3926
Standard ANSI
Tool Material HSS-E (Cobalt)
Spiral Point Straight flute
Chamfer Form B • 3.5 - 5
Class of Fit 2B



Through holes **Bright Finish** **External cooling**

d1 - P	H Limits	Tap Drill Range inch	Number of Flutes	d2 inch	SW inch	l1 inch	l3 inch	Order Code	EDP Number	Stock
4-48	H2/H3	0.089 - 0.097	2	0.141	0.110	2.205	0.709	2.845	9039260028450	●
5-44	H2/H3	0.100 - 0.108	2	0.141	0.110	2.205	0.709	3.175	9039260031750	●
6-40	H2/H3	0.111 - 0.119	3	0.141	0.110	2.000	0.748	3.505	9039260035050	●
8-36	H2/H3	0.134 - 0.142	3	0.168	0.131	2.130	0.827	4.166	9039260041660	●
10-32	H3/H4	0.156 - 0.164	3	0.194	0.152	2.382	0.945	4.826	9039260048260	●
12-28	H3/H4	0.177 - 0.186	3	0.220	0.165	2.382	1.024	5.486	9039260054860	●
1/4-28	H3/H4	0.211 - 0.220	3	0.255	0.191	2.500	1.181	6.350	9039260063500	●
5/16-24	H3/H4	0.267 - 0.277	3	0.318	0.238	2.721	1.377	7.938	9039260079380	●
3/8-24	H3/H4	0.330 - 0.340	3	0.381	0.286	2.941	1.456	9.525	9039260095250	●
7/16-20	H4/H5	0.383 - 0.395	3	0.323	0.242	3.161	N/A	11.113	9039260111130	●
1/2-20	H4/H5	0.446 - 0.457	3	0.367	0.275	3.382	N/A	12.700	9039260127000	●
5/8-18	H4/H5	0.565 - 0.578	3	0.480	0.360	3.811	N/A	15.875	9039260158750	●

UNF

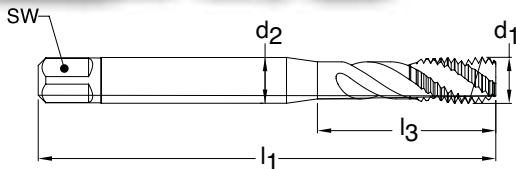

Series 3932
Standard ANSI
Tool Material HSS-E (Cobalt)
Spiral Flute 45° Helix
Chamfer Form C • 2-3
Class of Fit 2B

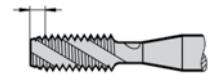

Blind holes **Bright finish** **External cooling**

d1 - P	H Limits	Tap Drill Range inch	Number of Flutes	d2 inch	SW inch	l1 inch	l3 inch	Order Code	EDP Number	Stock
4-48	H2/H3	0.089 - 0.097	2	0.141	0.110	2.205	0.709	2.845	9039320028450	●
5-44	H2/H3	0.100 - 0.108	2	0.141	0.110	2.205	0.709	3.175	9039320031750	●
6-40	H2/H3	0.111 - 0.119	2	0.141	0.110	2.000	0.748	3.505	9039320035050	●
8-36	H2/H3	0.134 - 0.142	2	0.168	0.131	2.130	0.827	4.166	9039320041660	●
10-32	H3/H4	0.156 - 0.164	2	0.194	0.152	2.382	0.945	4.826	9039320048260	●
12-28	H3/H4	0.177 - 0.186	2	0.220	0.165	2.382	1.024	5.486	9039320054860	●
1/4-28	H3/H4	0.211 - 0.220	2	0.255	0.191	2.500	1.181	6.350	9039320063500	●
5/16-24	H3/H4	0.267 - 0.277	2	0.318	0.238	2.721	1.377	7.938	9039320079380	●
3/8-24	H3/H4	0.330 - 0.340	2	0.381	0.286	2.941	1.456	9.525	9039320095250	●
7/16-20	H4/H5	0.383 - 0.395	2	0.323	0.242	3.161	N/A	11.113	9039320111130	●
1/2-20	H4/H5	0.446 - 0.457	2	0.367	0.275	3.382	N/A	12.700	9039320127000	●
5/8-18	H4/H5	0.565 - 0.578	3	0.480	0.360	3.811	N/A	15.875	9039320158750	●

"Tap drill Range" given is per the Class of Fit shown per Series #
 Additional Tap Drill sizes & percent of thread engagement can be found on pages 229-237.

UNC

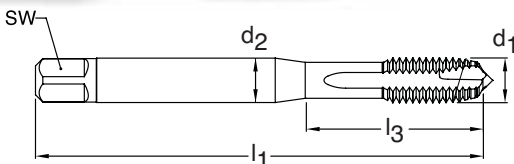

Series 3928
Standard ANSI
Tool Material HSS-E (Cobalt)
Spiral Point Straight flute
Chamfer Form B • 3.5 - 5
Class of Fit 2B

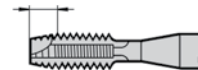

Through holes **TiN coated** **External cooling**

d1 - P	H Limits	Tap Drill Range inch	Number of Flutes	d2 inch	SW inch	l1 inch	l3 inch	Order Code	EDP Number	Stock
4-40	H2/H3	0.085 - 0.094	2	0.141	0.110	2.205	0.709	2.845	9039280028450	●
5-40	H2/H3	0.098 - 0.106	2	0.141	0.110	2.205	0.709	3.175	9039280031750	●
6-32	H3/H4	0.104 - 0.114	3	0.141	0.110	2.000	0.748	3.505	9039280035050	●
8-32	H3/H4	0.130 - 0.139	3	0.168	0.131	2.130	0.827	4.166	9039280041660	●
10-24	H3/H4	0.145 - 0.155	3	0.194	0.152	2.382	0.945	4.826	9039280048260	●
12-24	H3/H4	0.171 - 0.181	3	0.220	0.165	2.382	1.024	5.486	9039280054860	●
1/4-20	H4/H5	0.196 - 0.207	3	0.255	0.191	2.500	1.181	6.350	9039280063500	●
5/16-18	H4/H5	0.252 - 0.265	3	0.318	0.238	2.721	1.377	7.938	9039280079380	●
3/8-16	H5/H6	0.307 - 0.321	3	0.381	0.286	2.941	1.456	9.525	9039280095250	●
7/16-14	H5/H6	0.360 - 0.376	3	0.323	0.242	3.161	N/A	11.113	9039280111130	●
1/2-13	H5/H6	0.417 - 0.434	3	0.367	0.275	3.382	N/A	12.700	9039280127000	●
5/8-11	H5/H6	0.527 - 0.546	3	0.480	0.360	3.811	N/A	15.875	9039280158750	●

UNC

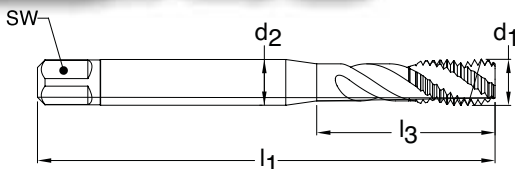

Series 3934
Standard ANSI
Tool Material HSS-E (Cobalt)
Spiral Flute 45° Helix
Chamfer Form C • 2-3
Class of Fit 2B



Blind holes **TiN coated** **External cooling**

d1 - P	H Limits	Tap Drill Range inch	Number of Flutes	d2 inch	SW inch	l1 inch	l3 inch	Order Code	EDP Number	Stock
4-40	H2/H3	0.085 - 0.094	2	0.141	0.110	2.205	0.709	2.845	9039340028450	●
5-40	H2/H3	0.098 - 0.106	2	0.141	0.110	2.205	0.709	3.175	9039340031750	●
6-32	H3/H4	0.104 - 0.114	2	0.141	0.110	2.000	0.748	3.505	9039340035050	●
8-32	H3/H4	0.130 - 0.139	2	0.168	0.131	2.130	0.827	4.166	9039340041660	●
10-24	H3/H4	0.145 - 0.155	2	0.194	0.152	2.382	0.945	4.826	9039340048260	●
12-24	H3/H4	0.171 - 0.181	2	0.220	0.165	2.382	1.024	5.486	9039340054860	●
1/4-20	H4/H5	0.196 - 0.207	2	0.255	0.191	2.500	1.181	6.350	9039340063500	●
5/16-18	H4/H5	0.252 - 0.265	2	0.318	0.238	2.721	1.377	7.938	9039340079380	●
3/8-16	H5/H6	0.307 - 0.321	2	0.381	0.286	2.941	1.456	9.525	9039340095250	●
7/16-14	H5/H6	0.360 - 0.376	2	0.323	0.242	3.161	N/A	11.113	9039340111130	●
1/2-13	H5/H6	0.417 - 0.434	2	0.367	0.275	3.382	N/A	12.700	9039340127000	●
5/8-11	H5/H6	0.527 - 0.546	3	0.480	0.360	3.811	N/A	15.875	9039340158750	●

UNF

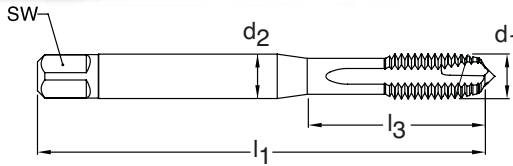

Series 3929
Standard ANSI
Tool Material HSS-E (Cobalt)
Spiral Point Straight flute
Chamfer Form B • 3.5 - 5
Class of Fit 2B



Through holes **TiN coated** **External cooling**

d1 - P	H Limits	Tap Drill Range inch	Number of Flutes	d2 inch	SW inch	l1 inch	l3 inch	Order Code	EDP Number	Stock
4-48	H2/H3	0.089 - 0.097	2	0.141	0.110	2.205	0.709	2.845	9039290028450	●
5-44	H2/H3	0.100 - 0.108	2	0.141	0.110	2.205	0.709	3.175	9039290031750	●
6-40	H2/H3	0.111 - 0.119	3	0.141	0.110	2.000	0.748	3.505	9039290035050	●
8-36	H2/H3	0.134 - 0.142	3	0.168	0.131	2.130	0.827	4.166	9039290041660	●
10-32	H3/H4	0.156 - 0.164	3	0.194	0.152	2.382	0.945	4.826	9039290048260	●
12-28	H3/H4	0.177 - 0.186	3	0.220	0.165	2.382	1.024	5.486	9039290054860	●
1/4-28	H3/H4	0.211 - 0.220	3	0.255	0.191	2.500	1.181	6.350	9039290063500	●
5/16-24	H3/H4	0.267 - 0.277	3	0.318	0.238	2.721	1.377	7.938	9039290079380	●
3/8-24	H3/H4	0.330 - 0.340	3	0.381	0.286	2.941	1.456	9.525	9039290095250	●
7/16-20	H4/H5	0.383 - 0.395	3	0.323	0.242	3.161	N/A	11.113	9039290111130	●
1/2-20	H4/H5	0.446 - 0.457	3	0.367	0.275	3.382	N/A	12.700	9039290127000	●
5/8-18	H4/H5	0.565 - 0.578	3	0.480	0.360	3.811	N/A	15.875	9039290158750	●

UNF

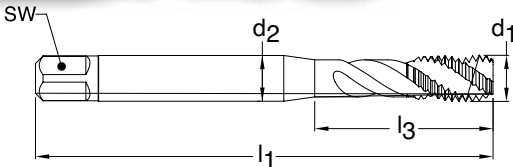

Series 3935
Standard ANSI
Tool Material HSS-E (Cobalt)
Spiral Flute 45° Helix
Chamfer Form C • 2-3
Class of Fit 2B



Blind holes **TiN coated** **External cooling**

d1 - P	H Limits	Tap Drill Range inch	Number of Flutes	d2 inch	SW inch	l1 inch	l3 inch	Order Code	EDP Number	Stock
4-48	H2/H3	0.089 - 0.097	2	0.141	0.110	2.205	0.709	2.845	9039350028450	●
5-44	H2/H3	0.100 - 0.108	2	0.141	0.110	2.205	0.709	3.175	9039350031750	●
6-40	H2/H3	0.111 - 0.119	2	0.141	0.110	2.000	0.748	3.505	9039350035050	●
8-36	H2/H3	0.134 - 0.142	2	0.168	0.131	2.130	0.827	4.166	9039350041660	●
10-32	H3/H4	0.156 - 0.164	2	0.194	0.152	2.382	0.945	4.826	9039350048260	●
12-28	H3/H4	0.177 - 0.186	2	0.220	0.165	2.382	1.024	5.486	9039350054860	●
1/4-28	H3/H4	0.211 - 0.220	2	0.255	0.191	2.500	1.181	6.350	9039350063500	●
5/16-24	H3/H4	0.267 - 0.277	2	0.318	0.238	2.721	1.377	7.938	9039350079380	●
3/8-24	H3/H4	0.330 - 0.340	2	0.381	0.286	2.941	1.456	9.525	9039350095250	●
7/16-20	H4/H5	0.383 - 0.395	2	0.323	0.242	3.161	N/A	11.113	9039350111130	●
1/2-20	H4/H5	0.446 - 0.457	2	0.367	0.275	3.382	N/A	12.700	9039350127000	●
5/8-18	H4/H5	0.565 - 0.578	3	0.480	0.360	3.811	N/A	15.875	9039350158750	●

"Tap drill Range" given is per the Class of Fit shown per Series #
 Additional Tap Drill sizes & percent of thread engagement can be found on pages 229-237.

UNC

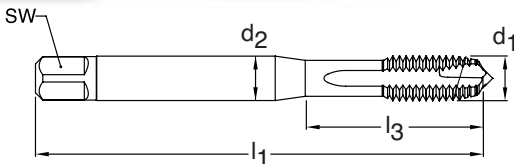

Series 3967
Standard ANSI
Tool Material HSS-E (Cobalt)
Spiral Point Straight flute

Chamfer Form B • 3.5 - 5

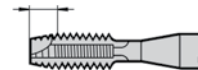

Class of Fit 2B

Through holes **MolyGlide® coated** **External cooling**

d1 - P	H Limits	Tap Drill Range inch	Number of Flutes	d2 inch	SW inch	l1 inch	l3 inch	Order Code	EDP Number	Stock
4-40	H2/H3	0.085 - 0.094	2	0.141	0.110	2.205	0.709	2.845	9039670028450	●
5-40	H2/H3	0.098 - 0.106	2	0.141	0.110	2.205	0.709	3.175	9039670031750	●
6-32	H3/H4	0.104 - 0.114	3	0.141	0.110	2.000	0.748	3.505	9039670035050	●
8-32	H3/H4	0.130 - 0.139	3	0.168	0.131	2.130	0.827	4.166	9039670041660	●
10-24	H3/H4	0.145 - 0.155	3	0.194	0.152	2.382	0.945	4.826	9039670048260	●
12-24	H3/H4	0.171 - 0.181	3	0.220	0.165	2.382	1.024	5.486	9039670054860	●
1/4-20	H4/H5	0.196 - 0.207	3	0.255	0.191	2.500	1.181	6.350	9039670063500	●
5/16-18	H4/H5	0.252 - 0.265	3	0.318	0.238	2.721	1.377	7.938	9039670079380	●
3/8-16	H5/H6	0.307 - 0.321	3	0.381	0.286	2.941	1.456	9.525	9039670095250	●
7/16-14	H5/H6	0.360 - 0.376	3	0.323	0.242	3.161	N/A	11.113	9039670111130	●
1/2-13	H5/H6	0.417 - 0.434	3	0.367	0.275	3.382	N/A	12.700	9039670127000	●
5/8-11	H5/H6	0.527 - 0.546	3	0.480	0.360	3.811	N/A	15.875	9039670158750	●

UNC

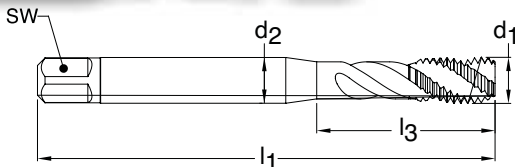

Series 3970
Standard ANSI
Tool Material HSS-E (Cobalt)
Spiral Flute 45° Helix

Chamfer Form C • 2-3



Class of Fit 2B

Blind holes **MolyGlide® coated** **External cooling**

d1 - P	H Limits	Tap Drill Range inch	Number of Flutes	d2 inch	SW inch	l1 inch	l3 inch	Order Code	EDP Number	Stock
4-40	H2/H3	0.085 - 0.094	2	0.141	0.110	2.205	0.709	2.845	9039700028450	●
5-40	H2/H3	0.098 - 0.106	2	0.141	0.110	2.205	0.709	3.175	9039700031750	●
6-32	H3/H4	0.104 - 0.114	2	0.141	0.110	2.000	0.748	3.505	9039700035050	●
8-32	H3/H4	0.130 - 0.139	2	0.168	0.131	2.130	0.827	4.166	9039700041660	●
10-24	H3/H4	0.145 - 0.155	2	0.194	0.152	2.382	0.945	4.826	9039700048260	●
12-24	H3/H4	0.171 - 0.181	2	0.220	0.165	2.382	1.024	5.486	9039700054860	●
1/4-20	H4/H5	0.196 - 0.207	2	0.255	0.191	2.500	1.181	6.350	9039700063500	●
5/16-18	H4/H5	0.252 - 0.265	2	0.318	0.238	2.721	1.377	7.938	9039700079380	●
3/8-16	H5/H6	0.307 - 0.321	2	0.381	0.286	2.941	1.456	9.525	9039700095250	●
7/16-14	H5/H6	0.360 - 0.376	2	0.323	0.242	3.161	N/A	11.113	9039700111130	●
1/2-13	H5/H6	0.417 - 0.434	2	0.367	0.275	3.382	N/A	12.700	9039700127000	●
5/8-11	H5/H6	0.527 - 0.546	3	0.480	0.360	3.811	N/A	15.875	9039700158750	●

UNF

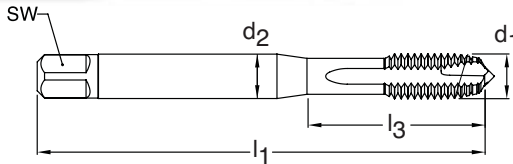

Series 3968
Standard ANSI
Tool Material HSS-E (Cobalt)
Spiral Point Straight flute
Chamfer Form B • 3.5 - 5
Class of Fit 2B



Through holes **MolyGlide® coated** **External cooling**

d1 - P	H Limits	Tap Drill Range inch	Number of Flutes	d2 inch	SW inch	l1 inch	l3 inch	Order Code	EDP Number	Stock
4-48	H2/H3	0.089 - 0.097	2	0.141	0.110	2.205	0.709	2.845	9039680028450	●
5-44	H2/H3	0.100 - 0.108	2	0.141	0.110	2.205	0.709	3.175	9039680031750	●
6-40	H2/H3	0.111 - 0.119	3	0.141	0.110	2.000	0.748	3.505	9039680035050	●
8-36	H2/H3	0.134 - 0.142	3	0.168	0.131	2.130	0.827	4.166	9039680041660	●
10-32	H3/H4	0.156 - 0.164	3	0.194	0.152	2.382	0.945	4.826	9039680048260	●
12-28	H3/H4	0.177 - 0.186	3	0.220	0.165	2.382	1.024	5.486	9039680054860	●
1/4-28	H3/H4	0.211 - 0.220	3	0.255	0.191	2.500	1.181	6.350	9039680063500	●
5/16-24	H3/H4	0.267 - 0.277	3	0.318	0.238	2.721	1.377	7.938	9039680079380	●
3/8-24	H3/H4	0.330 - 0.340	3	0.381	0.286	2.941	1.456	9.525	9039680095250	●
7/16-20	H4/H5	0.383 - 0.395	3	0.323	0.242	3.161	N/A	11.113	9039680111130	●
1/2-20	H4/H5	0.446 - 0.457	3	0.367	0.275	3.382	N/A	12.700	9039680127000	●
5/8-18	H4/H5	0.565 - 0.578	3	0.480	0.360	3.811	N/A	15.875	9039680158750	●

UNF

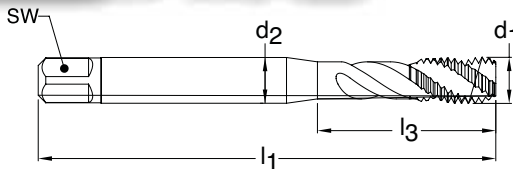

Series 3971
Standard ANSI
Tool Material HSS-E (Cobalt)
Spiral Flute 45° Helix
Chamfer Form C • 2-3
Class of Fit 2B

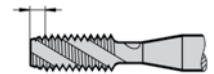

Blind holes **MolyGlide® coated** **External cooling**

d1 - P	H Limits	Tap Drill Range inch	Number of Flutes	d2 inch	SW inch	l1 inch	l3 inch	Order Code	EDP Number	Stock
4-48	H2/H3	0.089 - 0.097	2	0.141	0.110	2.205	0.709	2.845	9039710028450	●
5-44	H2/H3	0.100 - 0.108	2	0.141	0.110	2.205	0.709	3.175	9039710031750	●
6-40	H2/H3	0.111 - 0.119	2	0.141	0.110	2.000	0.748	3.505	9039710035050	●
8-36	H2/H3	0.134 - 0.142	2	0.168	0.131	2.130	0.827	4.166	9039710041660	●
10-32	H3/H4	0.156 - 0.164	2	0.194	0.152	2.382	0.945	4.826	9039710048260	●
12-28	H3/H4	0.177 - 0.186	2	0.220	0.165	2.382	1.024	5.486	9039710054860	●
1/4-28	H3/H4	0.211 - 0.220	2	0.255	0.191	2.500	1.181	6.350	9039710063500	●
5/16-24	H3/H4	0.267 - 0.277	2	0.318	0.238	2.721	1.377	7.938	9039710079380	●
3/8-24	H3/H4	0.330 - 0.340	2	0.381	0.286	2.941	1.456	9.525	9039710095250	●
7/16-20	H4/H5	0.383 - 0.395	2	0.323	0.242	3.161	N/A	11.113	9039710111130	●
1/2-20	H4/H5	0.446 - 0.457	2	0.367	0.275	3.382	N/A	12.700	9039710127000	●
5/8-18	H4/H5	0.565 - 0.578	3	0.480	0.360	3.811	N/A	15.875	9039710158750	●

"Tap drill Range" given is per the Class of Fit shown per Series #
 Additional Tap Drill sizes & percent of thread engagement can be found on pages 229-237.

UNC

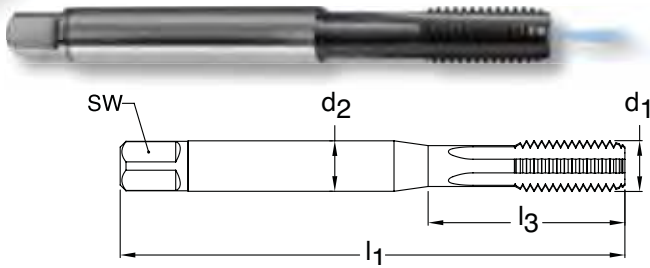

Series 4394
Standard DIN/ANSI
Tool Material HSS-E-PM
Flute Straight Flute
Chamfer Form C • 2-3
Class of Fit 2BX

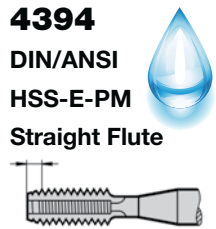

Blind holes **TiCN coated** **Axial coolant**

d1 - P	H Limits	Tap Drill Range inch	Number of Flutes	d2 inch	SW inch	l1 inch	l3 inch	Order Code	EDP Number	Stock
10-24	H4/H5	0.145 - 0.155	3	0.194	0.152	2.756	0.945	4.826	9043940048260	●
1/4-20	H5/H6	0.196 - 0.207	3	0.255	0.191	3.150	1.181	6.350	9043940063500	●
5/16-18	H5/H6	0.252 - 0.265	3	0.318	0.238	3.543	1.377	7.938	9043940079380	●
3/8-16	H6/H7	0.307 - 0.321	3	0.381	0.286	3.937	1.456	9.525	9043940095250	●
1/2-13	H6/H7	0.417 - 0.434	3	0.367	0.275	4.331	N/A	12.700	9043940127000	●
5/8-11	H6/H7	0.527 - 0.546	4	0.480	0.360	4.331	N/A	15.875	9043940158750	●
3/4-10	H6/H7	0.642 - 0.663	4	0.590	0.442	4.921	N/A	19.050	9043940190500	●
7/8-9	H7/H8	0.755 - 0.778	5	0.697	0.523	5.512	N/A	22.225	9043940222250	●
1-8	H7/H8	0.865 - 0.890	5	0.800	0.600	6.299	N/A	25.400	9043940254000	●

UNF

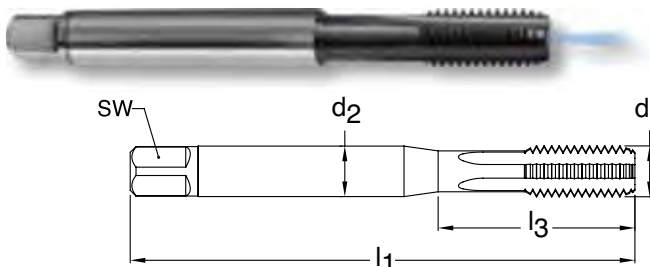

Series 4391
Standard DIN/ANSI
Tool Material HSS-E-PM
Flute Straight Flute
Chamfer Form C • 2-3
Class of Fit 2BX

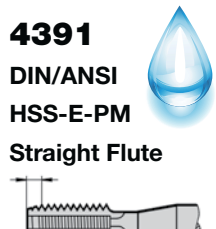

Blind holes **TiCN coated** **Axial coolant**

d1 - P	H Limits	Tap Drill Range inch	Number of Flutes	d2 inch	SW inch	l1 inch	l3 inch	Order Code	EDP Number	Stock
10-32	H4/H5	0.156 - 0.164	3	0.194	0.152	2.756	0.945	4.826	9043910048260	●
1/4-28	H4/H5	0.211 - 0.220	3	0.255	0.191	3.150	1.181	6.350	9043910063500	●
5/16-24	H4/H5	0.267 - 0.277	3	0.318	0.238	3.543	1.377	7.938	9043910079380	●
3/8-24	H4/H5	0.330 - 0.340	3	0.381	0.286	3.543	1.456	9.525	9043910095250	●
1/2-20	H5/H6	0.446 - 0.457	3	0.367	0.275	3.937	N/A	12.700	9043910127000	●
5/8-18	H5/H6	0.565 - 0.578	4	0.480	0.360	3.937	N/A	15.875	9043910158750	●
3/4-16	H6/H7	0.682 - 0.696	4	0.590	0.442	4.331	N/A	19.050	9043910190500	●
7/8-14	H7/H8	0.798 - 0.813	5	0.697	0.523	4.921	N/A	22.225	9043910222250	●
1-12	H7/H8	0.910 - 0.928	5	0.800	0.600	5.512	N/A	25.400	9043910254000	●

UNC

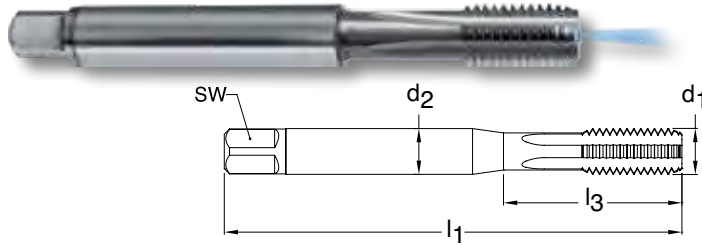

Series 4118
Standard DIN/ANSI
Tool Material Carbide
Flute Straight flute
Chamfer Form C • 2-3
Class of Fit 2B



Blind holes



Bright finish



Axial coolant

d1 - P	H Limits	Tap Drill Range inch	Number of Flutes	d2 inch	SW inch	l1 inch	l3 inch	Order Code	EDP Number	Stock
10-24	H3/H4	0.145 - 0.155	4	0.194	0.152	2.756	0.945	4.826	9041180048260	●
12-24	H3/H4	0.171 - 0.181	4	0.220	0.165	3.150	1.024	5.486	9041180054860	●
1/4-20	H4/H5	0.196 - 0.207	4	0.255	0.191	3.150	1.181	6.350	9041180063500	●
5/16-18	H4/H5	0.252 - 0.265	4	0.318	0.238	3.543	1.377	7.938	9041180079380	●
3/8-16	H5/H6	0.307 - 0.321	4	0.381	0.286	3.937	1.456	9.525	9041180095250	●
7/16-14	H5/H6	0.360 - 0.376	4	0.323	0.242	3.937	N/A	11.113	9041180111130	●
1/2-13	H5/H6	0.417 - 0.434	4	0.367	0.275	4.331	N/A	12.700	9041180127000	●
5/8-11	H5/H6	0.527 - 0.546	4	0.480	0.360	4.331	N/A	15.875	9041180158750	●
3/4-10	H5/H6	0.642 - 0.663	4	0.590	0.442	4.921	N/A	19.050	9041180190500	●

UNF

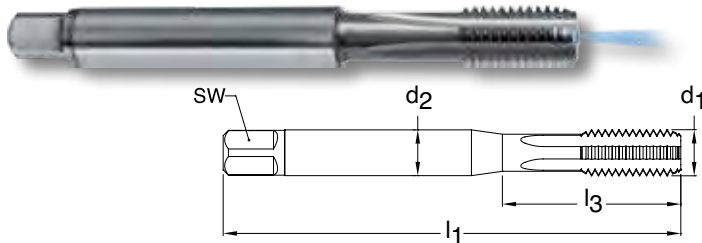

Series 4119
Standard DIN/ANSI
Tool Material Carbide
Flute Straight flute
Chamfer Form C • 2-3
Class of Fit 2B



Blind holes



Bright finish



Axial coolant

d1 - P	H Limits	Tap Drill Range inch	Number of Flutes	d2 inch	SW inch	l1 inch	l3 inch	Order Code	EDP Number	Stock
10-32	H3/H4	0.156 - 0.164	4	0.194	0.152	2.756	0.945	4.826	9041190048260	●
12-28	H3/H4	0.177 - 0.186	4	0.220	0.165	3.150	1.024	5.486	9041190054860	●
1/4-28	H3/H4	0.211 - 0.220	4	0.255	0.191	3.150	1.181	6.350	9041190063500	●
5/16-24	H3/H4	0.267 - 0.277	4	0.318	0.238	3.543	1.377	7.938	9041190079380	●
3/8-24	H3/H4	0.330 - 0.340	4	0.381	0.286	3.543	1.456	9.525	9041190095250	●
7/16-20	H4/H5	0.383 - 0.395	4	0.323	0.242	3.937	N/A	11.113	9041190111130	●
1/2-20	H4/H5	0.446 - 0.457	4	0.367	0.275	3.937	N/A	12.700	9041190127000	●
5/8-18	H4/H5	0.565 - 0.578	4	0.480	0.360	3.937	N/A	15.875	9041190158750	●
3/4-16	H5/H6	0.682 - 0.696	4	0.590	0.442	4.331	N/A	19.050	9041190190500	●

"Tap drill Range" given is per the Class of Fit shown per Series #
 Additional Tap Drill sizes & percent of thread engagement can be found on pages 229-237.

METRIC

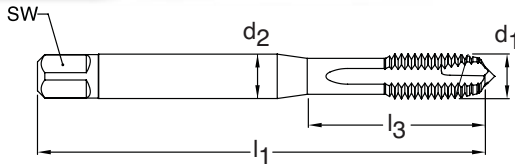

Series 3924
Standard ANSI
Tool Material HSS-E (Cobalt)
Spiral Point Straight flute
Chamfer Form B • 3.5 - 5
Class of Fit ISO 2(6H)



Through holes **Bright Finish** **External cooling**

d1 - P	D Limits	Tap Drill Range mm	Number of Flutes	d2 inch	SW inch	l1 inch	l3 inch	Order Code	EDP Number	Stock
M3 X 0.50	D2/D3	2.459 - 2.599	3	0.141	0.110	1.941	0.709	3.000	9039240030000	●
M4 X 0.70	D3/D4	3.242 - 3.422	3	0.168	0.131	2.130	0.827	4.000	9039240040000	●
M5 X 0.80	D3/D4	4.134 - 4.334	3	0.194	0.152	2.382	0.945	5.000	9039240050000	●
M6 X 1.00	D4/D5	4.917 - 5.153	3	0.255	0.191	2.500	1.181	6.000	9039240060000	●
M8 X 1.25	D4/D5	6.647 - 6.912	3	0.318	0.238	2.721	1.377	8.000	9039240080000	●
M10 X 1.50	D4/D5	8.376 - 8.676	3	0.381	0.286	2.941	1.456	10.000	9039240100000	●
M12 X 1.75	D5/D6	10.106 - 10.441	3	0.367	0.275	3.382	N/A	12.000	9039240120000	●
M14 X 2.00	D5/D6	11.835 - 12.210	3	0.429	0.322	3.591	N/A	14.000	9039240140000	●
M16 X 2.00	D6/D7	13.835 - 14.210	3	0.480	0.360	3.811	N/A	16.000	9039240160000	●

METRIC

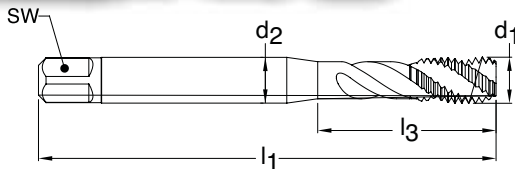

Series 3930
Standard ANSI
Tool Material HSS-E (Cobalt)
Spiral Flute 45° Helix
Chamfer Form C • 2-3
Class of Fit ISO 2(6H)

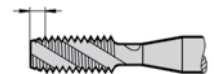

Blind holes **Bright finish** **External cooling**

d1 - P	D Limits	Tap Drill Range mm	Number of Flutes	d2 inch	SW inch	l1 inch	l3 inch	Order Code	EDP Number	Stock
M3 X 0.50	D2/D3	2.459 - 2.599	2	0.141	0.110	1.941	0.709	3.000	9039300030000	●
M4 X 0.70	D3/D4	3.242 - 3.422	2	0.168	0.131	2.130	0.827	4.000	9039300040000	●
M5 X 0.80	D3/D4	4.134 - 4.334	2	0.194	0.152	2.382	0.945	5.000	9039300050000	●
M6 X 1.00	D4/D5	4.917 - 5.153	2	0.255	0.191	2.500	1.181	6.000	9039300060000	●
M8 X 1.25	D4/D5	6.647 - 6.912	2	0.318	0.238	2.721	1.377	8.000	9039300080000	●
M10 X 1.50	D4/D5	8.376 - 8.676	2	0.381	0.286	2.941	1.456	10.000	9039300100000	●
M12 X 1.75	D5/D6	10.106 - 10.441	2	0.367	0.275	3.382	N/A	12.000	9039300120000	●
M14 X 2.00	D5/D6	11.835 - 12.210	3	0.429	0.322	3.591	N/A	14.000	9039300140000	●
M16 X 2.00	D6/D7	13.835 - 14.210	3	0.480	0.360	3.811	N/A	16.000	9039300160000	●

METRIC

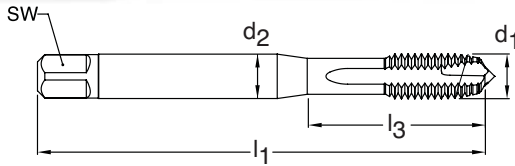

Series 3927
Standard ANSI
Tool Material HSS-E (Cobalt)
Spiral Point Straight flute
Chamfer Form B • 3.5 - 5
Class of Fit ISO 2(6H)

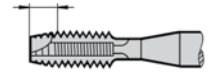

Through holes



TiN coated



External cooling

d1 - P	D Limits	Tap Drill Range mm	Number of Flutes	d2 inch	SW inch	l1 inch	l3 inch	Order Code	EDP Number	Stock
M3 X 0.50	D2/D3	2.459 - 2.599	3	0.141	0.110	1.941	0.709	3.000	9039270030000	●
M4 X 0.70	D3/D4	3.242 - 3.422	3	0.168	0.131	2.130	0.827	4.000	9039270040000	●
M5 X 0.80	D3/D4	4.134 - 4.334	3	0.194	0.152	2.382	0.945	5.000	9039270050000	●
M6 X 1.00	D4/D5	4.917 - 5.153	3	0.255	0.191	2.500	1.181	6.000	9039270060000	●
M8 X 1.25	D4/D5	6.647 - 6.912	3	0.318	0.238	2.721	1.377	8.000	9039270080000	●
M10 X 1.50	D4/D5	8.376 - 8.676	3	0.381	0.286	2.941	1.456	10.000	9039270100000	●
M12 X 1.75	D5/D6	10.106 - 10.441	3	0.367	0.275	3.382	N/A	12.000	9039270120000	●
M14 X 2.00	D5/D6	11.835 - 12.210	3	0.429	0.322	3.591	N/A	14.000	9039270140000	●
M16 X 2.00	D6/D7	13.835 - 14.210	3	0.480	0.360	3.811	N/A	16.000	9039270160000	●

METRIC

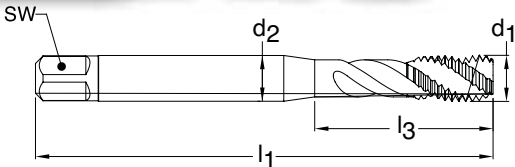

Series 3933
Standard ANSI
Tool Material HSS-E (Cobalt)
Spiral Flute 45° Helix
Chamfer Form C • 2-3
Class of Fit ISO 2(6H)

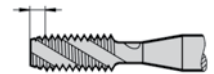

Blind holes



TiN coated



External cooling

d1 - P	D Limits	Tap Drill Range mm	Number of Flutes	d2 inch	SW inch	l1 inch	l3 inch	Order Code	EDP Number	Stock
M3 X 0.50	D2/D3	2.459 - 2.599	2	0.141	0.110	1.941	0.709	3.000	9039330030000	●
M4 X 0.70	D3/D4	3.242 - 3.422	2	0.168	0.131	2.130	0.827	4.000	9039330040000	●
M5 X 0.80	D3/D4	4.134 - 4.334	2	0.194	0.152	2.382	0.945	5.000	9039330050000	●
M6 X 1.00	D4/D5	4.917 - 5.153	2	0.255	0.191	2.500	1.181	6.000	9039330060000	●
M8 X 1.25	D4/D5	6.647 - 6.912	2	0.318	0.238	2.721	1.377	8.000	9039330080000	●
M10 X 1.50	D4/D5	8.376 - 8.676	2	0.381	0.286	2.941	1.456	10.000	9039330100000	●
M12 X 1.75	D5/D6	10.106 - 10.441	2	0.367	0.275	3.382	N/A	12.000	9039330120000	●
M14 X 2.00	D5/D6	11.835 - 12.210	3	0.429	0.322	3.591	N/A	14.000	9039330140000	●
M16 X 2.00	D6/D7	13.835 - 14.210	3	0.480	0.360	3.811	N/A	16.000	9039330160000	●

"Tap drill Range" given is per the Class of Fit shown per Series #
 Additional Tap Drill sizes & percent of thread engagement can be found on pages 229-237.

METRIC

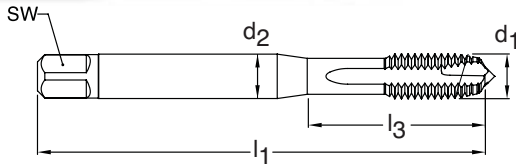

Series 3966
Standard ANSI
Tool Material HSS-E (Cobalt)
Spiral Point Straight flute
Chamfer Form B • 3.5 - 5
Class of Fit ISO 2(6H)

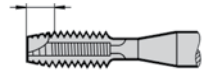

Through holes **MolyGlide® coated** **External cooling**

d1 - P	D Limits	Tap Drill Range mm	Number of Flutes	d2 inch	SW inch	l1 inch	l3 inch	Order Code	EDP Number	Stock
M3 X 0.50	D2/D3	2.459 - 2.599	3	0.141	0.110	1.941	0.709	3.000	9039660030000	●
M4 X 0.70	D3/D4	3.242 - 3.422	3	0.168	0.131	2.130	0.827	4.000	9039660040000	●
M5 X 0.80	D3/D4	4.134 - 4.334	3	0.194	0.152	2.382	0.945	5.000	9039660050000	●
M6 X 1.00	D4/D5	4.917 - 5.153	3	0.255	0.191	2.500	1.181	6.000	9039660060000	●
M8 X 1.25	D4/D5	6.647 - 6.912	3	0.318	0.238	2.721	1.377	8.000	9039660080000	●
M10 X 1.50	D4/D5	8.376 - 8.676	3	0.381	0.286	2.941	1.456	10.000	9039660100000	●
M12 X 1.75	D5/D6	10.106 - 10.441	3	0.367	0.275	3.382	N/A	12.000	9039660120000	●
M14 X 2.00	D5/D6	11.835 - 12.210	3	0.429	0.322	3.591	N/A	14.000	9039660140000	●
M16 X 2.00	D6/D7	13.835 - 14.210	3	0.480	0.360	3.811	N/A	16.000	9039660160000	●

METRIC

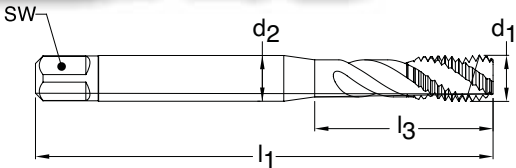

Series 3969
Standard ANSI
Tool Material HSS-E (Cobalt)
Spiral Flute 45° Helix
Chamfer Form C • 2-3
Class of Fit ISO 2(6H)

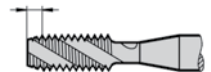

Blind holes **MolyGlide® coated** **External cooling**

d1 - P	D Limits	Tap Drill Range mm	Number of Flutes	d2 inch	SW inch	l1 inch	l3 inch	Order Code	EDP Number	Stock
M3 X 0.50	D2/D3	2.459 - 2.599	2	0.141	0.110	1.941	0.709	3.000	9039690030000	●
M4 X 0.70	D3/D4	3.242 - 3.422	2	0.168	0.131	2.130	0.827	4.000	9039690040000	●
M5 X 0.80	D3/D4	4.134 - 4.334	2	0.194	0.152	2.382	0.945	5.000	9039690050000	●
M6 X 1.00	D4/D5	4.917 - 5.153	2	0.255	0.191	2.500	1.181	6.000	9039690060000	●
M8 X 1.25	D4/D5	6.647 - 6.912	2	0.318	0.238	2.721	1.377	8.000	9039690080000	●
M10 X 1.50	D4/D5	8.376 - 8.676	2	0.381	0.286	2.941	1.456	10.000	9039690100000	●
M12 X 1.75	D5/D6	10.106 - 10.441	2	0.367	0.275	3.382	N/A	12.000	9039690120000	●
M14 X 2.00	D5/D6	11.835 - 12.210	3	0.429	0.322	3.591	N/A	14.000	9039690140000	●
M16 X 2.00	D6/D7	13.835 - 14.210	3	0.480	0.360	3.811	N/A	16.000	9039690160000	●

METRIC

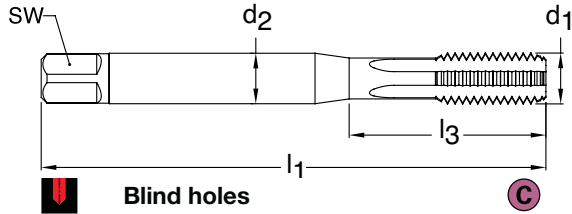

Blind holes



TiCN coated



Axial coolant

Series 302
Standard DIN 371
Tool Material HSS-E-PM
Flute Straight Flute
Chamfer Form C • 2-3
Class of Fit 6HX



d1 - P	D Limits	Tap Drill Range mm	Number of Flutes	d2 mm	SW mm	l1 mm	l3 mm	Order Code	EDP Number	Stock
M 5 X 0.80	D4/D5	4.134 - 4.334	3	6.00	4.90	70.00	25.00	5.000	9003020050000	○
M 6 X 1.00	D5/D6	4.917 - 5.153	3	6.00	4.90	80.00	30.00	6.000	9003020060000	●
M 8 X 1.25	D5/D6	6.647 - 6.912	3	8.00	6.20	90.00	35.00	8.000	9003020080000	●
M10 X 1.50	D5/D6	8.376 - 8.676	3	10.00	8.00	100.00	39.00	10.000	9003020100000	●

METRIC

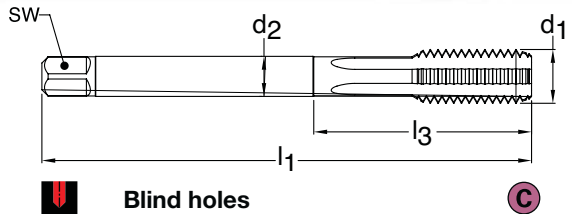

Blind holes



TiCN coated



Axial coolant

Series 297
Standard DIN 376
Tool Material HSS-E-PM
Flute Straight Flute
Chamfer Form C • 2-3
Class of Fit 6HX



d1 - P	D Limits	Tap Drill Range mm	Number of Flutes	d2 mm	SW mm	l1 mm	l3 mm	Order Code	EDP Number	Stock
M10 X 1.50	D5/D6	8.376 - 8.676	3	7.00	5.50	100.00	N/A	10.000	9002970100000	●
M12 X 1.75	D6/D7	10.106 - 10.441	3	9.00	7.00	110.00	N/A	12.000	9002970120000	●
M14 X 2.00	D6/D7	11.835 - 12.210	3	11.00	9.00	110.00	N/A	14.000	9002970140000	○

METRIC FINE

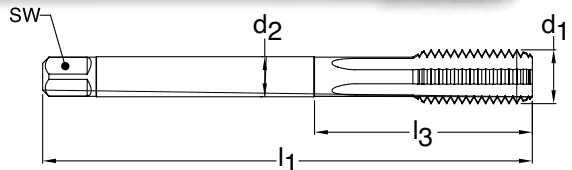

Blind holes



TiCN coated



Axial coolant

Series 1090
Standard DIN 374
Tool Material HSS-E-PM
Flute Straight Flute
Chamfer Form C • 2-3
Class of Fit 6HX



d1 - P	D Limits	Tap Drill Range mm	Number of Flutes	d2 mm	SW mm	l1 mm	l3 mm	Order Code	EDP Number	Stock
M5 X 0.50	D4/D5	4.459 - 4.599	3	3.50	2.70	70.00	N/A	5.003	9010900050030	○
M 6 X 0.50	D5/D6	5.460 - 5.600	3	4.50	3.40	80.00	N/A	6.003	9010900060030	○
M6 X 0.75	D5/D6	5.188 - 5.378	3	4.50	3.40	80.00	N/A	6.004	9010900060040	○
M8 X 0.75	D5/D6	7.188 - 7.378	3	6.00	4.90	80.00	N/A	8.004	9010900080040	○
M8 X 1.00	D5/D6	6.917 - 7.153	3	6.00	4.90	90.00	N/A	8.005	9010900080050	●
M10 X 1.00	D5/D6	8.917 - 9.153	3	7.00	5.50	90.00	N/A	10.005	9010900100050	●
M10 X 1.25	D5/D6	8.647 - 8.912	3	7.00	5.50	100.00	N/A	10.006	9010900100060	○
M12 X 1.00	D5/D6	10.917 - 11.153	3	9.00	7.00	100.00	N/A	12.005	9010900120050	●
M12 X 1.25	D5/D6	10.647 - 10.912	3	9.00	7.00	100.00	N/A	12.006	9010900120060	●
M12 X 1.50	D5/D6	10.376 - 10.676	3	9.00	7.00	100.00	N/A	12.007	9010900120070	●
M14 X 1.50	D5/D6	12.376 - 12.676	3	11.00	9.00	100.00	N/A	14.007	9010900140070	●
M16 X 1.50	D5/D6	14.376 - 14.676	4	12.00	9.00	100.00	N/A	16.007	9010900160070	○

"Tap drill Range" given is per the Class of Fit shown per Series #
 Additional Tap Drill sizes & percent of thread engagement can be found on pages 229-237.

METRIC

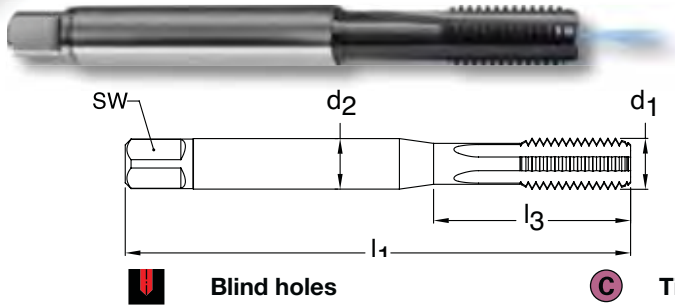

Blind holes



TiCN coated



Axial coolant

Chamfer Form E • 1.5 - 2

Series 1091
Standard DIN 371
Tool Material HSS-E-PM
Flute Straight Flute



Class of Fit 6HX

d1 - P	D Limits	Tap Drill Range mm	Number of Flutes	d2 mm	SW mm	l1 mm	l3 mm	Order Code	EDP Number	Stock
M5 X 0.80	D4/D5	4.134 - 4.334	3	6.00	4.90	70.00	25.00	5.000	9010910050000	○
M6 X 1.00	D5/D6	4.917 - 5.153	3	6.00	4.90	80.00	30.00	6.000	9010910060000	●
M8 X 1.25	D5/D6	6.647 - 6.912	3	8.00	6.20	90.00	35.00	8.000	9010910080000	●
M10 X 1.50	D5/D6	8.376 - 8.676	3	10.00	8.00	100.00	39.00	10.000	9010910100000	●

METRIC

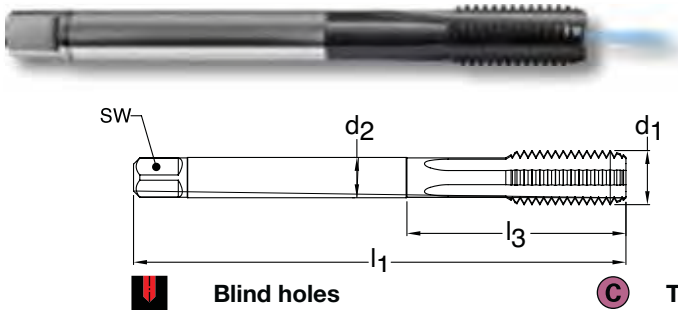

Blind holes



TiCN coated



Axial coolant

Chamfer Form E • 1.5 - 2

Series 4165
Standard DIN 376
Tool Material HSS-E-PM
Flute Straight Flute



Class of Fit 6HX

d1 - P	D Limits	Tap Drill Range mm	Number of Flutes	d2 mm	SW mm	l1 mm	l3 mm	Order Code	EDP Number	Stock
M10 X 1.50	D5/D6	8.376 - 8.676	3	7.00	5.50	100.00	N/A	10.000	9041650100000	○
M12 X 1.75	D6/D7	10.106 - 10.441	3	9.00	7.00	110.00	N/A	12.000	9041650120000	○
M16 X 2.00	D7/D8	13.835 - 14.210	4	12.00	9.00	110.00	N/A	16.000	9041650160000	○
M20 X 2.50	D7/D8	17.294 - 17.744	4	16.00	12.00	140.00	N/A	20.000	9041650200000	○

METRIC FINE

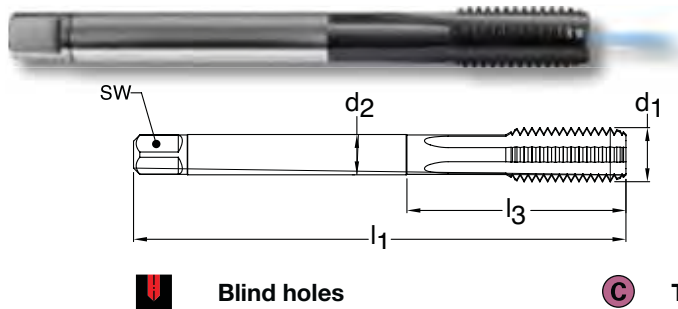

Blind holes



TiCN coated



Axial coolant

Chamfer Form E • 1.5 - 2

Series 1007
Standard DIN 374
Tool Material HSS-E-PM
Flute Straight Flute



Class of Fit 6HX

d1 - P	D Limits	Tap Drill Range mm	Number of Flutes	d2 mm	SW mm	l1 mm	l3 mm	Order Code	EDP Number	Stock
M5 X 0.50	D4/D5	4.459 - 4.599	3	3.50	2.70	70.00	N/A	5.003	9010070050030	○
M6 X 0.50	D5/D6	5.460 - 5.600	3	4.50	3.40	80.00	N/A	6.003	9010070060030	○
M6 X 0.75	D5/D6	5.188 - 5.378	3	4.50	3.40	80.00	N/A	6.004	9010070060040	○
M8 X 0.75	D5/D6	7.188 - 7.378	3	6.00	4.90	80.00	N/A	8.004	9010070080040	○
M8 X 1.00	D5/D6	6.917 - 7.153	3	6.00	4.90	90.00	N/A	8.005	9010070080050	●
M9 X 1.00	D5/D6	7.917 - 8.153	3	7.00	5.50	90.00	N/A	9.005	9010070090050	●
M10 X 1.00	D5/D6	8.917 - 9.153	3	7.00	5.50	90.00	N/A	10.005	9010070100050	●
M10 X 1.25	D5/D6	8.647 - 8.912	3	7.00	5.50	100.00	N/A	10.006	9010070100060	●
M12 X 1.00	D5/D6	10.917 - 11.153	3	9.00	7.00	100.00	N/A	12.005	9010070120050	○
M12 X 1.25	D5/D6	10.647 - 10.912	3	9.00	7.00	100.00	N/A	12.006	9010070120060	●
M12 X 1.50	D5/D6	10.376 - 10.676	3	9.00	7.00	100.00	N/A	12.007	9010070120070	●
M14 X 1.00	D5/D6	12.917 - 13.153	3	11.00	9.00	100.00	N/A	14.005	9010070140050	○
M14 X 1.25	D5/D6	12.647 - 12.912	3	11.00	9.00	100.00	N/A	14.006	9010070140060	●
M14 X 1.50	D5/D6	12.376 - 12.676	3	11.00	9.00	100.00	N/A	14.007	9010070140070	●
M16 X 1.00	D5/D6	14.917 - 15.153	4	12.00	9.00	100.00	N/A	16.005	9010070160050	○
M16 X 1.50	D5/D6	14.376 - 14.676	4	12.00	9.00	100.00	N/A	16.007	9010070160070	●

METRIC

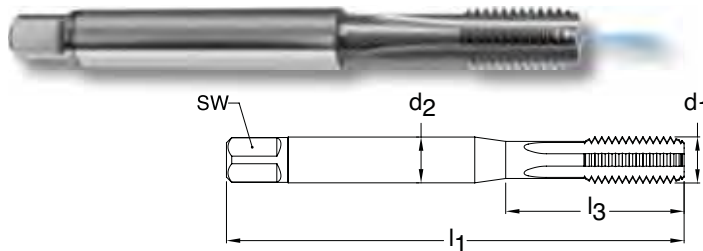

Series 1008
Standard DIN 371
Tool Material Carbide
Flute Straight flute

Chamfer Form E • 1.5-2

Class of Fit 6HX



Blind holes



Bright finish



Axial coolant

d1 - P	D Limits	Tap Drill Range mm	Number of Flutes	d2 mm	SW mm	l1 mm	l3 mm	Order Code	EDP Number	Stock
*M3 X 0.50	D3/D4	2.459 - 2.599	3	3.50	2.70	56.00	18.00	3.000	9010080030000	○
*M4 X 0.70	D4/D5	3.242 - 3.422	3	4.50	3.40	63.00	21.00	4.000	9010080040000	○
M5 X 0.80	D4/D5	4.134 - 4.334	4	6.00	4.90	70.00	25.00	5.000	9010080050000	○
M6 X 1.00	D5/D6	4.917 - 5.153	4	6.00	4.90	80.00	30.00	6.000	9010080060000	●
M8 X 1.25	D5/D6	6.647 - 6.912	4	8.00	6.20	90.00	35.00	8.000	9010080080000	●
M10 X 1.50	D5/D6	8.376 - 8.676	4	10.00	8.00	100.00	39.00	10.000	9010080100000	●

* M3, M4 no axial coolant

METRIC FINE

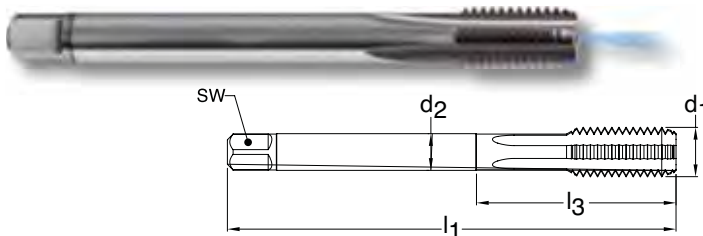

Series 1009
Standard DIN 374
Tool Material Carbide
Flute Straight flute

Chamfer Form E • 1.5-2

Class of Fit 6HX



Blind holes



Bright finish



Axial coolant

d1 - P	D Limits	Tap Drill Range mm	Number of Flutes	d2 mm	SW mm	l1 mm	l3 mm	Order Code	EDP Number	Stock
M10 X 1.00	D5/D6	8.917 - 9.153	4	10.00	8.00	90.00	N/A	10.005	9010090100050	○
M12 X 1.00	D5/D6	10.917 - 11.153	4	9.00	7.00	100.00	N/A	12.005	9010090120050	○
M12 X 1.50	D5/D6	10.376 - 10.676	4	9.00	7.00	100.00	N/A	12.007	9010090120070	○
M14 X 1.50	D5/D6	12.376 - 12.676	4	11.00	9.00	100.00	N/A	14.007	9010090140070	○
M16 X 1.50	D5/D6	14.376 - 14.676	4	12.00	9.00	100.00	N/A	16.007	9010090160070	○

"Tap drill Range" given is per the Class of Fit shown per Series #
 Additional Tap Drill sizes & percent of thread engagement can be found on pages 229-237.

METRIC

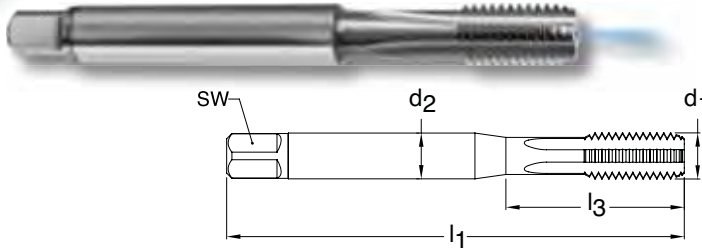

Series 969
Standard DIN 371
Tool Material Carbide
Flute Straight flute
Chamfer Form C • 2-3
Class of Fit 6HX



Blind holes **Bright finish** **Axial coolant**

d1 - P	D Limits	Tap Drill Range mm	Number of Flutes	d2 mm	SW mm	l1 mm	l3 mm	Order Code	EDP Number	Stock
*M3 X 0.50	D3/D4	2.459 - 2.599	3	3.50	2.70	56.00	18.00	3.000	9009690030000	○
*M4 X 0.70	D4/D5	3.242 - 3.422	3	4.50	3.40	63.00	21.00	4.000	9009690040000	●
M5 X 0.80	D4/D5	4.134 - 4.334	4	6.00	4.90	70.00	25.00	5.000	9009690050000	●
M6 X 1.00	D5/D6	4.917 - 5.153	4	6.00	4.90	80.00	30.00	6.000	9009690060000	●
M8 X 1.25	D5/D6	6.647 - 6.912	4	8.00	6.20	90.00	35.00	8.000	9009690080000	●
M10 X 1.50	D5/D6	8.376 - 8.676	4	10.00	8.00	100.00	39.00	10.000	9009690100000	●

* M3, M4 no axial coolant

METRIC

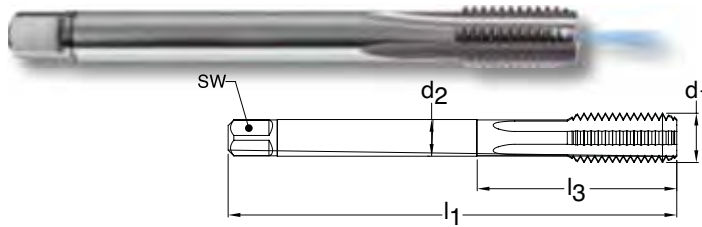

Series 1883
Standard DIN 376
Tool Material Carbide
Flute Straight flute
Chamfer Form C • 2-3
Class of Fit 6HX



Blind holes **Bright finish** **Axial coolant**

d1 - P	D Limits	Tap Drill Range mm	Number of Flutes	d2 mm	SW mm	l1 mm	l3 mm	Order Code	EDP Number	Stock
M12 X 1.75	D6/D7	10.106 - 10.441	4	9.00	7.00	110.00	N/A	12.000	9018830120000	●
M14 X 2.00	D6/D7	11.835 - 12.210	4	11.00	9.00	110.00	N/A	14.000	9018830140000	●
M16 X 2.00	D7/D8	13.835 - 14.210	4	12.00	9.00	110.00	N/A	16.000	9018830160000	●
M18 X 2.50	D7/D8	15.294 - 15.744	4	14.00	11.00	125.00	N/A	18.000	9018830180000	○
M20 X 2.50	D7/D8	17.294 - 17.744	4	16.00	12.00	140.00	N/A	20.000	9018830200000	●

METRIC FINE

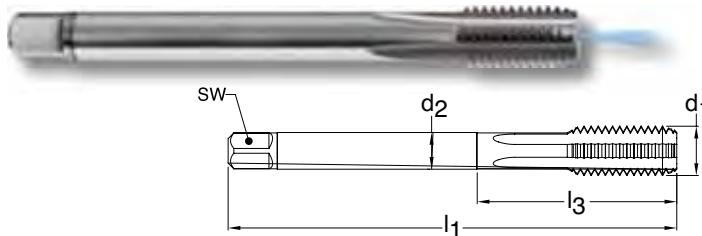

Series 974
Standard DIN 374
Tool Material Carbide
Flute Straight flute
Chamfer Form C • 2-3
Class of Fit 6HX



Blind holes **Bright finish** **Axial coolant**

d1 - P	D Limits	Tap Drill Range mm	Number of Flutes	d2 mm	SW mm	l1 mm	l3 mm	Order Code	EDP Number	Stock
M12 X 1.5	D5/D6	10.376 - 10.676	4	9.00	7.00	100.00	N/A	12.007	9009740120070	○
M14 X 1.5	D5/D6	12.376 - 12.676	4	11.00	9.00	100.00	N/A	14.007	9009740140070	○
M16 X 1.5	D5/D6	14.376 - 14.676	4	12.00	9.00	100.00	N/A	16.007	9009740160070	○
M18 X 1.5	D5/D6	16.376 - 16.676	4	14.00	11.00	110.00	N/A	18.007	9009740180070	○
M20 X 1.5	D7/D8	18.376 - 18.676	4	16.00	12.00	125.00	N/A	20.007	9009740200070	○

METRIC

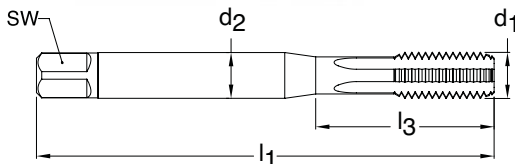

Series 1858
Standard DIN 371
Tool Material Carbide
Flute Straight flute
Chamfer Form C • 2-3
Class of Fit 6HX



Through holes **Blind holes** **Bright finish** **Radial coolant**

d1 - P	D Limits	Tap Drill Range mm	Number of Flutes	d2 mm	SW mm	l1 mm	l3 mm	Order Code	EDP Number	Stock
M5 X 0.80	D4/D5	4.134 - 4.334	4	6.00	4.90	70.00	25.00	5.000	9018580050000	●
M6 X 1.00	D5/D6	4.917 - 5.153	4	6.00	4.90	80.00	30.00	6.000	9018580060000	●
M8 X 1.25	D5/D6	6.647 - 6.912	4	8.00	6.20	90.00	35.00	8.000	9018580080000	●
M10 X 1.50	D5/D6	8.376 - 8.676	4	10.00	8.00	100.00	39.00	10.000	9018580100000	●

METRIC

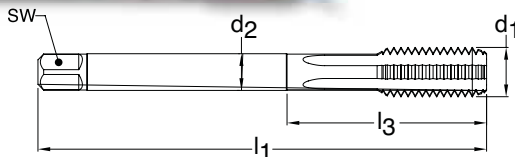

Series 1859
Standard DIN 376
Tool Material Carbide
Flute Straight flute
Chamfer Form C • 2-3
Class of Fit 6HX



Through holes **Blind holes** **Bright finish** **Radial coolant**

d1 - P	D Limits	Tap Drill Range mm	Number of Flutes	d2 mm	SW mm	l1 mm	l3 mm	Order Code	EDP Number	Stock
M12 X 1.75	D6/D7	10.106 - 10.441	4	9.00	7.00	110.00	N/A	12.000	9018590120000	●
M14 X 2.00	D6/D7	11.835 - 12.210	4	11.00	9.00	110.00	N/A	14.000	9018590140000	○
M16 X 2.00	D7/D8	13.835 - 14.210	4	12.00	9.00	110.00	N/A	16.000	9018590160000	●
M18 X 2.50	D7/D8	15.294 - 15.744	4	14.00	11.00	125.00	N/A	18.000	9018590180000	○
M20 X 2.50	D7/D8	17.294 - 17.744	4	16.00	12.00	140.00	N/A	20.000	9018590200000	●

METRIC FINE

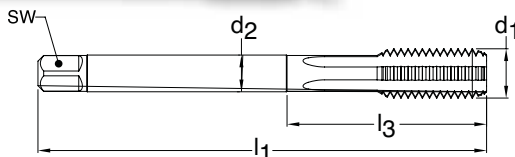

Series 1860
Standard DIN 374
Tool Material Carbide
Flute Straight flute
Chamfer Form C • 2-3
Class of Fit 6HX



Through holes **Blind holes** **Bright finish** **Radial coolant**

d1 - P	D Limits	Tap Drill Range mm	Number of Flutes	d2 mm	SW mm	l1 mm	l3 mm	Order Code	EDP Number	Stock
M12 X 1.50	D5/D6	10.376 - 10.676	4	9.00	7.00	100.00	N/A	12.007	9018600120070	●
M14 X 1.50	D5/D6	12.376 - 12.676	4	11.00	9.00	100.00	N/A	14.007	9018600140070	●
M16 X 1.50	D5/D6	14.376 - 14.676	4	12.00	9.00	100.00	N/A	16.007	9018600160070	●
M18 X 1.50	D5/D6	16.376 - 16.676	4	14.00	11.00	110.00	N/A	18.007	9018600180070	○
M20 X 1.50	D7/D8	18.376 - 18.676	4	16.00	12.00	125.00	N/A	20.007	9018600200070	○

"Tap drill Range" given is per the Class of Fit shown per Series #
 Additional Tap Drill sizes & percent of thread engagement can be found on pages 229-237.

METRIC

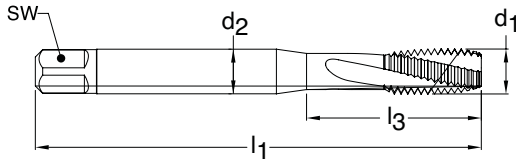

Blind holes



Bright finish



Axial coolant

Series 971
Standard DIN 371
Tool Material Carbide
Spiral Flute 15° Helix
Chamfer Form C • 2-3
Class of Fit 6HX



d1 - P	D Limits	Tap Drill Range inch	Number of Flutes	d2 inch	SW inch	l1 inch	l3 inch	Order Code	EDP Number	Stock
*M3 X 0.50	D3/D4	2.459 - 2.599	3	3.50	2.70	56.00	18.00	3.000	9009710030000	○
*M4 X 0.70	D4/D5	3.242 - 3.422	3	4.50	3.40	63.00	21.00	4.000	9009710040000	○
M5 X 0.80	D4/D5	4.134 - 4.334	3	6.00	4.90	70.00	25.00	5.000	9009710050000	●
M6 X 1.00	D5/D6	4.917 - 5.153	3	6.00	4.90	80.00	30.00	6.000	9009710060000	●
M8 X 1.25	D5/D6	6.647 - 6.912	3	8.00	6.20	90.00	35.00	8.000	9009710080000	●
M10 X 1.50	D5/D6	8.376 - 8.676	3	10.00	8.00	100.00	39.00	10.000	9009710100000	●

* M3, M4 no axial coolant

METRIC FINE

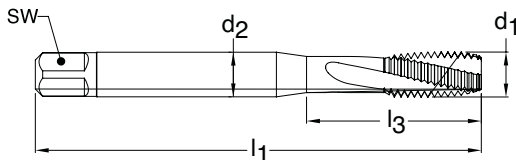

Blind holes



Bright finish



Axial coolant

Series 977
Standard DIN 371
Tool Material Carbide
Spiral Flute 15° Helix
Chamfer Form C • 2-3
Class of Fit 6HX

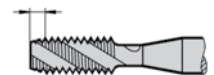

d1 - P	D Limits	Tap Drill Range inch	Number of Flutes	d2 inch	SW inch	l1 inch	l3 inch	Order Code	EDP Number	Stock
*M4 X 0.50	D4/D5	3.459 - 3.599	3	4.50	3.40	63.00	21.00	4.003	9009770040030	○
M5 X 0.50	D4/D5	4.459 - 4.599	3	6.00	4.90	70.00	25.00	5.003	9009770050030	○
M6 X 0.50	D4/D5	5.460 - 5.600	3	6.00	4.90	80.00	30.00	6.003	9009770060030	○
M8 X 1.00	D5/D6	6.917 - 7.153	3	8.00	6.20	90.00	35.00	8.005	9009770080050	○
M10 X 1.00	D5/D6	8.917 - 9.153	3	10.00	8.00	90.00	35.00	10.005	9009770100050	○

* M3, M4 no axial coolant

METRIC FINE

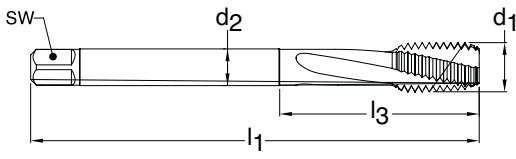

Blind holes



Bright finish



Axial coolant

Series 978
Standard DIN 374
Tool Material Carbide
Spiral Flute 15° Helix
Chamfer Form C • 2-3
Class of Fit 6HX



d1 - P	D Limits	Tap Drill Range mm	Number of Flutes	d2 mm	SW mm	l1 mm	l3 mm	Order Code	EDP Number	Stock
M12 X 1.50	D5/D6	10.376 - 10.676	4	9.00	7.00	100.00	N/A	12.007	9018600120070	●
M14 X 1.50	D5/D6	12.376 - 12.676	4	11.00	9.00	100.00	N/A	14.007	9018600140070	●
M16 X 1.50	D5/D6	14.376 - 14.676	4	12.00	9.00	100.00	N/A	16.007	9018600160070	●
M18 X 1.50	D5/D6	16.376 - 16.676	4	14.00	11.00	110.00	N/A	18.007	9018600180070	○

* M3, M4 no axial coolant

METRIC

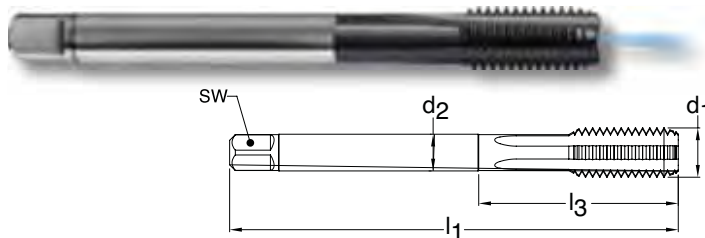

Series 778
Standard DIN 376
Tool Material HSS-E (Cobalt)
Flute Straight flute
Chamfer Form C • 2-3
Class of Fit 6HX



Blind holes



TiCN coated



Axial coolant

d1 - P	D Limits	Tap Drill Range mm	Number of Flutes	d2 mm	SW mm	l1 mm	l3 mm	Order Code	EDP Number	Stock
M16 X 2.00	D7/D8	13.835 - 14.210	4	12.00	9.00	110.00	N/A	16.000	9007780160000	●
M20 X 2.50	D7/D8	17.294 - 17.744	4	16.00	12.00	140.00	N/A	20.000	9007780200000	○
M24 X 3.00	D8/D9	20.752 - 21.252	5	18.00	14.50	160.00	N/A	24.000	9007780240000	●
M27 X 3.00	D8/D9	23.752 - 24.252	5	20.00	16.00	160.00	N/A	27.000	9007780270000	○
M30 X 3.50	D9/D10	26.211 - 26.771	5	22.00	18.00	180.00	N/A	30.000	9007780300000	●
M33 X 3.50	D9/D10	31.376 - 31.676	6	25.00	20.00	180.00	N/A	33.000	9007780330000	○
M36 X 4.00	D9/D10	31.670 - 32.270	6	28.00	22.00	200.00	N/A	36.000	9007780360000	○
M39 X 4.00	D10/D11	34.690 - 35.780	6	32.00	24.00	200.00	N/A	39.000	9007780390000	○

METRIC - EXTENDED LENGTH

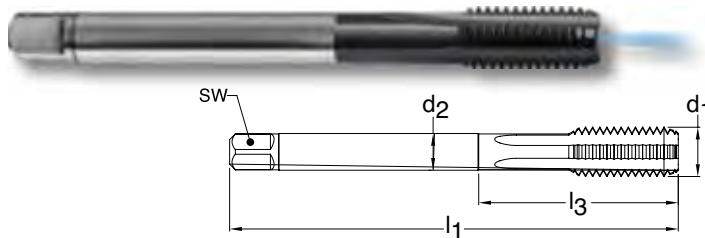

Series 779
Standard ~DIN 376
Tool Material HSS-E (Cobalt)
Flute Straight flute
Chamfer Form C • 2-3
Class of Fit 6HX



Blind holes



TiCN coated



Axial coolant

d1 - P	D Limits	Tap Drill Range mm	Number of Flutes	d2 mm	SW mm	l1 mm	l3 mm	Order Code	EDP Number	Stock
M16 X 2.00	D7/D8	13.835 - 14.210	3	12.00	9.00	160.00	N/A	16.000	9007790160000	○
M20 X 2.50	D7/D8	17.294 - 17.744	3	16.00	12.00	180.00	N/A	20.000	9007790200000	○
M24 X 3.00	D8/D9	20.752 - 21.252	4	18.00	14.50	200.00	N/A	24.000	9007790240000	○
M27 X 3.00	D8/D9	23.752 - 24.252	4	20.00	16.00	225.00	N/A	27.000	9007790270000	○
M30 X 3.50	D9/D10	26.211 - 26.711	4	22.00	18.00	250.00	N/A	30.000	9007790300000	○
M33 X 3.50	D9/D10	29.211 - 29.711	4	25.00	20.00	275.00	N/A	33.000	9007790330000	○
M36 X 4.00	D9/D10	31.670 - 32.270	5	28.00	22.00	300.00	N/A	36.000	9007790360000	○
M39 X 4.00	D11/D12	34.690 - 35.780	5	32.00	24.00	325.00	N/A	39.000	9007790390000	○

"Tap drill Range" given is per the Class of Fit shown per Series #
 Additional Tap Drill sizes & percent of thread engagement can be found on pages 229-237.

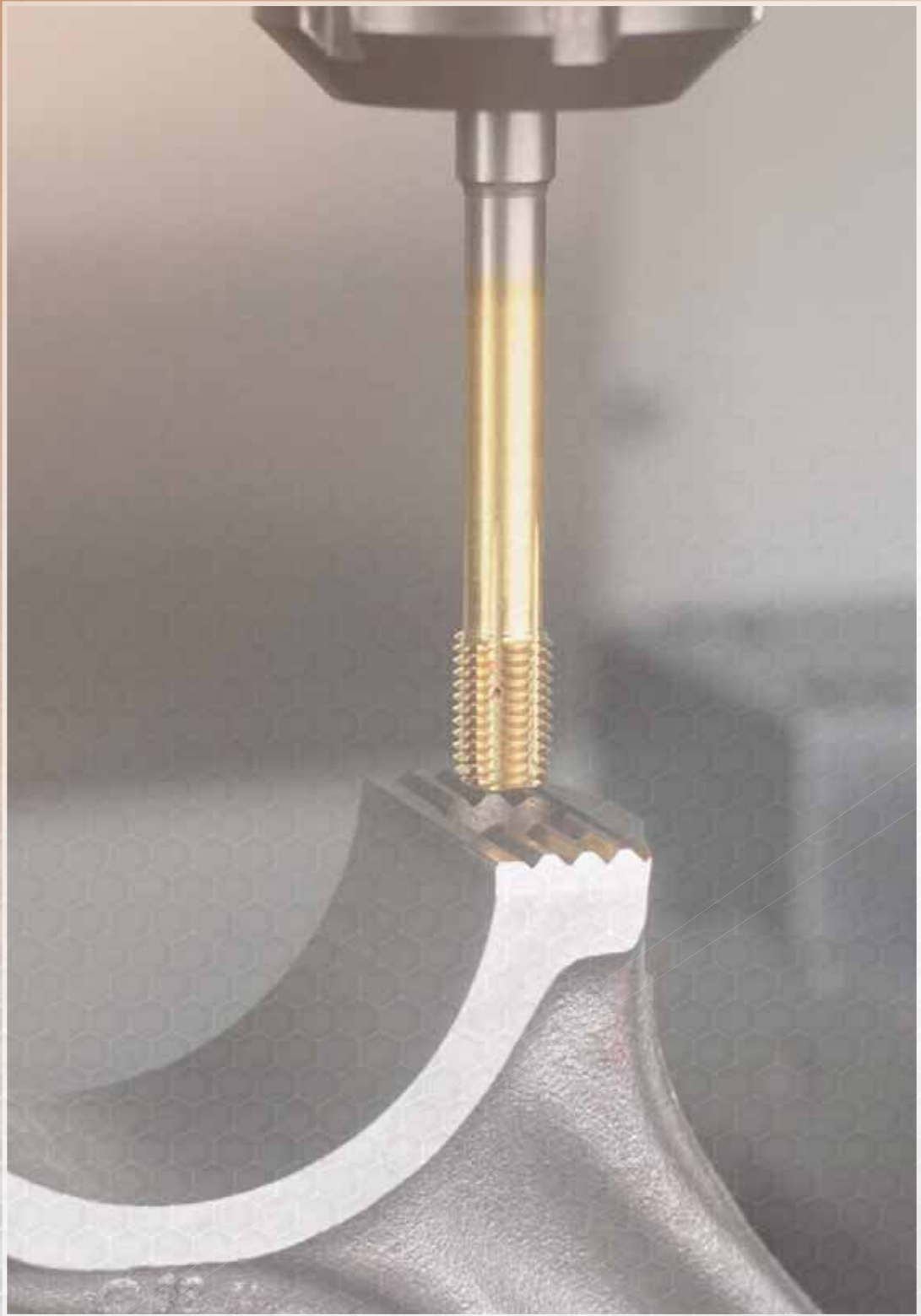

FORM TAPS

Material group	Approximate Rc	Approximate HB	Recommended SFM		
			HSS-E	HSS-E-PM	Solid carbide
Structural steels, free-cutting steels		<180	45-70	60-90	90-120
Unalloyed case hardened steels	<20	<230	40-65	55-80	75-100
Unalloyed heat-treatable steels	<25	<250	30-55	50-75	65-95
Structural steels, free-cutting steels	<20	<230	40-65	55-80	75-100
Case hardened steels, heat-treatable steels	<25	<250	30-55	50-75	65-95
Nitriding steels, spheroidal graphite iron	<30	<280	25-45	40-70	60-85
	<35	<320	20-35	35-60	50-75
	<38	<380	-	-	-
Stainless- and acid-resistant steels, sulphured austenitic martensitic		<180	40-50	45-60	50-70
	<25	<250	35-50	40-55	45-60
	<30	<280	25-40	35-50	40-55
	<35	<320	-	25-40	30-45
Alloyed case hardened steels Alloyed heat-treatable steels Alloyed tool steels High speed tool steels	<25	<250	25-45	40-60	55-80
	<30	<280	20-40	35-55	50-70
	<35	<320	15-30	30-50	40-60
	<38	<380	-	-	-
	<44	<415	-	-	-
	<60		-	-	-
Cast iron Spheroidal graphite iron Malleable cast iron		<180	-	-	-
	<25	<250	40-65	60-80	75-130
	<35	<320	40-65	60-80	75-130
Aluminium and Al-alloys Al cast alloys Al wrought alloys	Silicon Content	Wrought Aluminum			
	<10%	n/a	60-75	70-140	100-165
	>10%	n/a	-	-	-
	n/a	30-80	80-100	100-150	150-200
	n/a	75-150	80-100	100-150	150-200
Titanium and Ti-alloys		<320	7-26	7-26	20-35
		>320	-	-	-
Nickel and Ni-alloys		<320	7-26	7-26	20-35
		>320	-	-	-
Plastics			-	-	-
Magnesium-alloys			-	-	-
Brass, short-chipping long-chipping		<180	35-50	50-65	75-100
		<180	40-65	60-80	80-120

Fluteless taps and thread forming

Fluteless taps are used for the forming of internal threads without chip removal. In contrast to conventional tapping where material is cut from the workpiece, thread forming is a pressure deformation process without chip removal for the production of internal threads. During the process the material is cold formed without interrupting the grain flow.

According to DIN 8583, thread forming is described as “pressing the thread into the workpiece with a tool possessing a spiral working area”. The spiral threaded, polygonal portion of the fluteless tap is “screwed” into the pre-drilled workpiece with an appropriate constant feed rate equal to the thread pitch. The thread profile is pressed gradually via the forming lead into the material of the workpiece so to speak. Subsequently, the pressure in the deformation zone exceeds the compression limit, the workpiece becomes ductile and is deformed. The material yields radially, “flows” along the thread profile in the unoccupied base of the tool and forms the minor diameter of the nut thread. The flow process creates the process specific form pockets (claws).

The tapping size hole diameter is heavily dependent on the formability of the material, the workpiece geometry and the required effective depth of the thread. In comparison to conventional tapping, a larger diameter tapping size hole should be selected. With a larger diameter tapping size hole the load on the tool is reduced while increasing the tool life. Thanks to the uninterrupted grain flow, the loading capacity of the thread remains sufficient with a 50% effective thread depth.

The partially formed crests of the thread with decreasing effective thread depth are a typical characteristic of threads produced by the thread forming process. With the flanks of the thread fully

formed, they have no influence on the tensile strength of the thread. If necessary, the required deformation level of the thread should be determined by performing a test.

Lubrication is of significant importance. The lubrication prevents material from building up on the thread flanks and ensures that the necessary torque for the forming process is not too high. Therefore, under no circumstances should there ever be a break-down in lubrication! Preference should be given to lubricants such as cooling agents or oils containing graphite such as those used in rolling processes. Always follow the rule: “The better the lubrication the easier the thread forming process.”

It offers the following advantages:

- no chip formation.
- one tool for the production of threads in through and blind holes.
- application in wide range of materials.
- no cutting errors.
- pitch and angle of thread errors that can occur with thread cutting are eliminated.
- internal threads produced by thread forming possess a higher tensile strength particularly at the thread flanks thanks to the so-called “uninterrupted grain flow” and the cold forming process.
- the surface of the thread is improved.
- fluteless taps can be applied at higher speeds because the formability of many materials increases with the forming speed. This does not have a negative effect on the tool life.
- reduced danger of breakage through rigid design

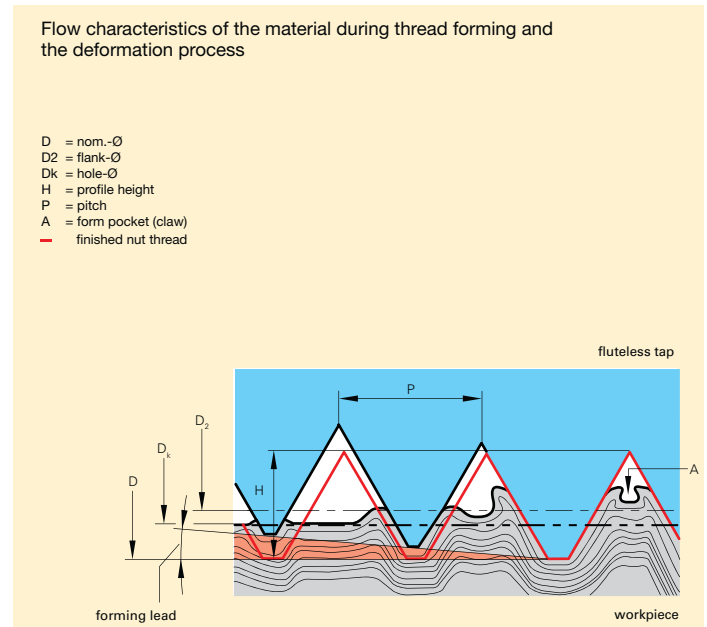
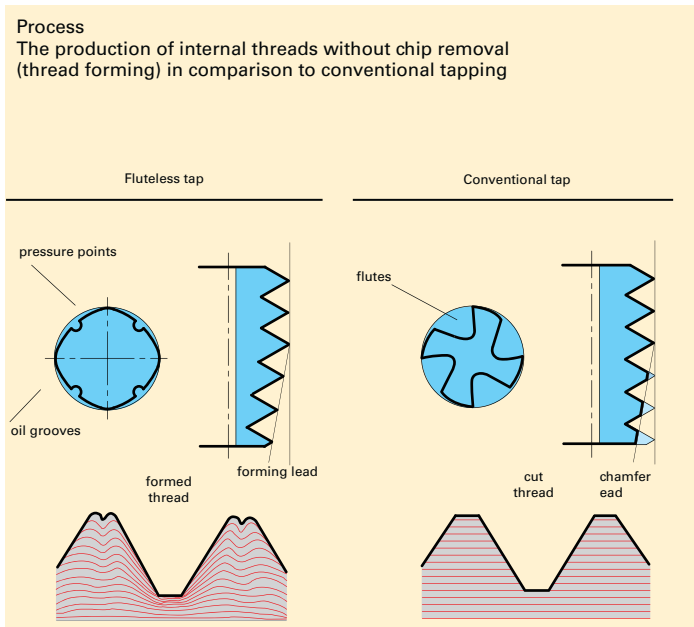

Guhring's fluteless taps - Characteristics and advantages

Conventional fluteless taps, produced by a grinding process only, show traces of microscopic, very fine grinding marks on the surface of the tool. This also applies to the threaded portion of the tool required to perform the thread forming operation.

This surface topography (structure) has a negative effect on the friction between the tool and the material to be re-formed as well as on the herewith associated heat development, on the necessary torque and last but not least on the wear of the pressure points of the fluteless tap. In addition, the "grinding marks" encourage the build-up of the material to be re-formed in the thread flanks of the fluteless tap. This is also called cold welding.

Thanks to a special process to improve the surface topography (structure), Guhring's new Profile fluteless taps no longer possess these "grinding marks". This has been confirmed in research and tool life studies in varying materials under production conditions.

For the user, a longer tool life and increased cutting speeds are the benefits of this special process. The tool life can be increased considerably depending on the material to be machined and the application conditions. A 100% increase in tool life is not unusual.

The improved surface topography is not only of benefit to tools with bright finish. Particularly coated tools also benefit from the new process. Outer contour and forming lead greatly determine the performance of the fluteless tap. Numerous tests have shown that fluteless taps with optimal pressure point geometry and quantity achieve increased tool life and dimensional accuracy.

Further improvements in quality are achieved when the fluteless tap is produced completely in one setting and with one grinding wheel - set-up with a special roll. Pitch errors between the thread crests and former lead transition area do not occur as with the conventional grinding process.

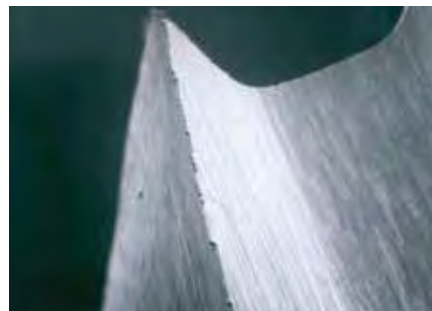

Surface of a conventional fluteless tap

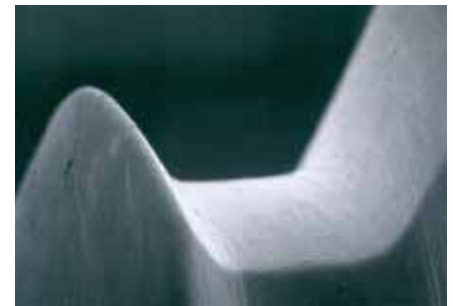

Optimized surface of a Guhring Profile fluteless tap

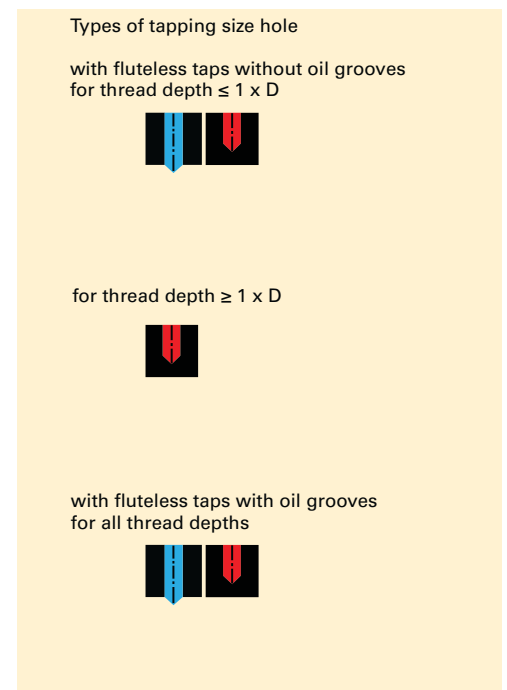
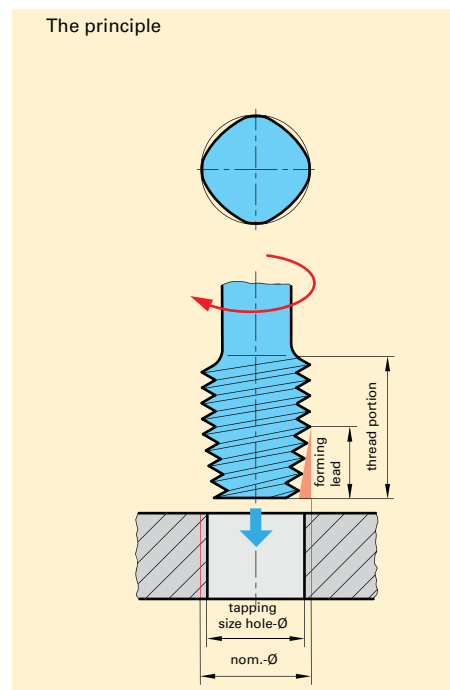
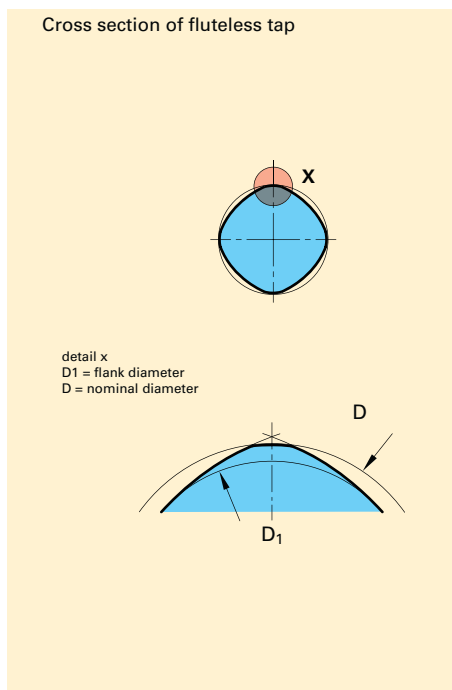

Definitions, angles, centers, thread tolerances and fits

Thread portion

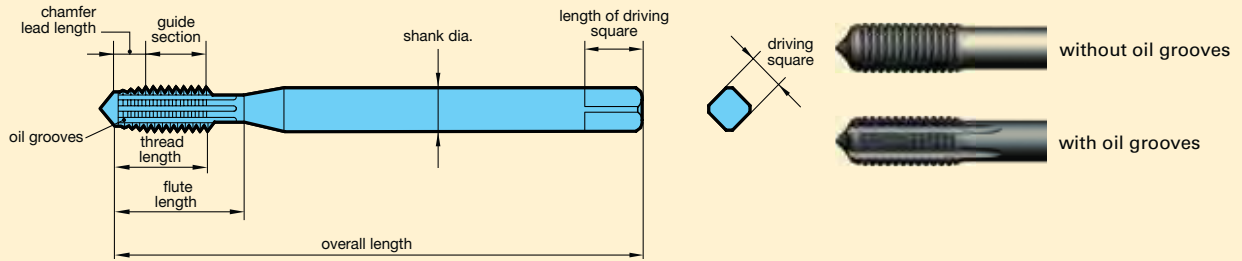

Types of centres (standard, to DIN 2197/DIN 2175)

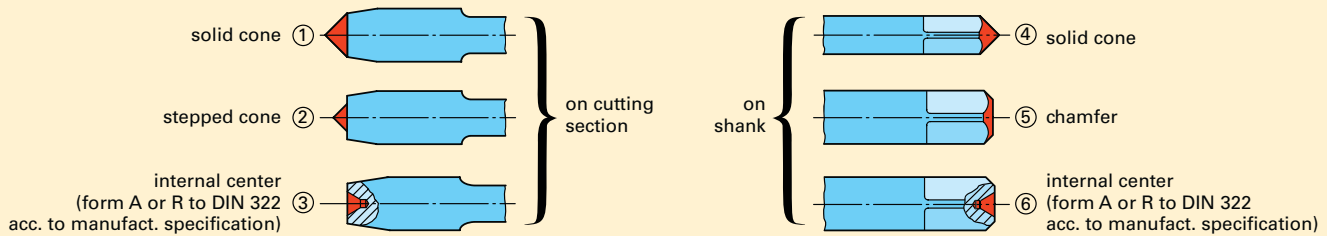

Thread dia. range mm	Center on cutting section		
	with chamfer forms A, C, D, E	with chamfer form B	Center on shank
≤ 5.6	①	①	④ ⑤ ⑥
> 5.6 ... 12.8	① ② ③	① ② ③	④ ⑤ ⑥
> 12.8	③	③	⑥

Thread tolerances and fits

Fits between internal and external threads are separated by a diagonal stroke, as for example 6H/6g (internal/external thread). The fit has to be selected in conjunction with the appropriate thread connection.

The tolerance zones of the tolerance classes fine, medium and coarse are allocated to three screw-in lengths short (S), normal (N) and long (L). Generally, the following rules apply for selecting a tolerance class:

Fine tolerance zone (S):

For precision threads, when only a small variation in the fit is permitted.

Screw-in lengths:

The quality of thread connection is also affected by the screw-in length. The ISO tolerance system was, especially as regards the pitch diameter, divided into three groups, i.e.

Medium tolerance zone (N):

General application

Coarse tolerance zone (L):

There are no special precision requirements and in cases where production difficulties may occur, e.g. thread production in hot-rolled rods, deep blind holes or plastic components.

The following fit should be selected for normal screw-in length N: To ensure a tighter fit of thread connections, we recommend for short screw-in lengths a narrower fit.

Thread fit with varying flank clearance

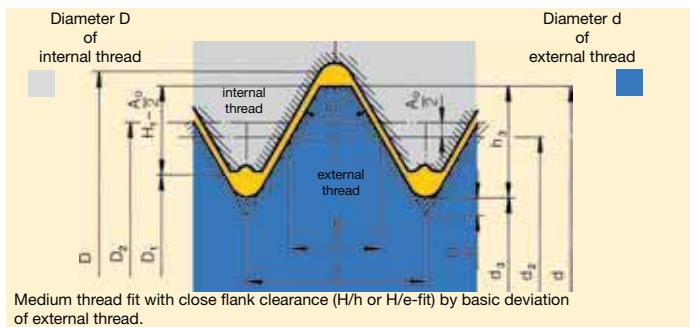
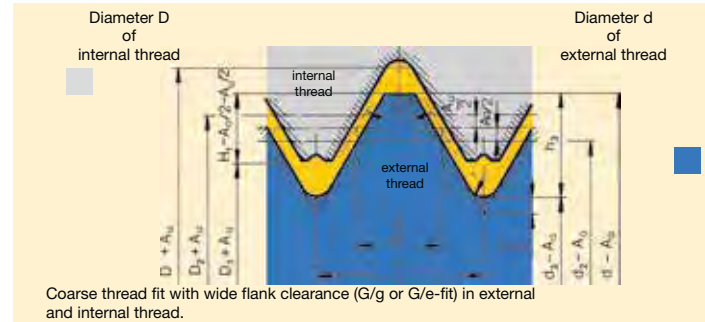
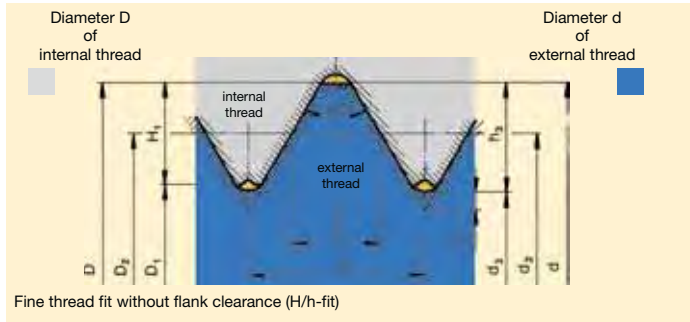

Explanation of symbols

- D = major diameter of internal thread
- D1 = nominal diameter of tapping size hole
- D2 = effective diameter of internal thread
- d = major diameter of external thread
- d2 = effective diameter of external thread
- d3 = root diameter of external thread
- P = pitch
- s = pitch angle
- H = peak to valley height of thread profile
- Ao = positive tolerance
- Au = negative tolerance

Tapping size hole diameter

With fluteless tapping, the tapping size hole diameter influences the distinction of the formed thread. A too small tapping size hole diameter results in an over-forming of the thread which must definitely be prevented because this can lead to tool breakage. A

too large tapping size hole is acceptable with certain tolerances because formed threads have a sufficient loading capacity from a 50% bearing depth.

<p>Tapping size hole diameter is too large:</p> <ul style="list-style-type: none"> • thread not formed • large form pocket (claw) • height of profile too low 	<p>Optimal tapping size hole diameter:</p> <ul style="list-style-type: none"> • thread fully formed • small form pocket (claw) • optimal height of profile 	<p>Tapping size hole too small:</p> <ul style="list-style-type: none"> • thread over-formed • no form pocket (claw) • profile too high
--	---	---

Cooling lubricants with fluteless taps

With fluteless taps the main task of the coolant is lubrication. The better the lubrication with the maximum concentration, the longer the tool life.

There are two different types of lubricant:

Oil based lubricants

These are mineral oils with the best lubricating characteristics. They reduce friction and achieve optimal life.

Soluble lubricants

Soluble, or emulsion, lubricants are concentrates mixed with water. Where a 6% emulsion is typically fine for most cutting processes, a higher level of lubricity is needed for thread forming. A content of 12% is ideal for forming threads. It should be noted that 50% of the success of thread forming is based on proper lubrication.

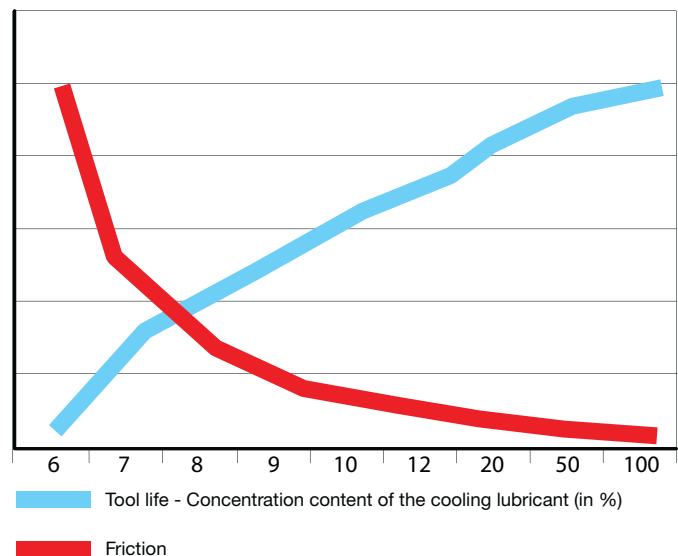

UNC

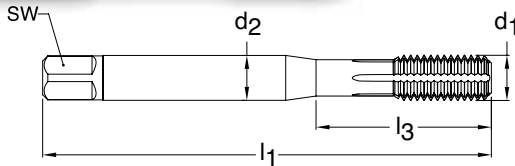

Through holes



Blind holes



TiN coated



External cooling

Series 3940
Standard ANSI
Tool Material HSS-E (Cobalt)
Flute Oil grooves
Chamfer Form C • 2-3
Class of Fit 2BX



d1 - P	H Limits	Tap Drill Range inch	Number of Flutes	d2 inch	SW inch	l1 inch	l3 inch	Order Code	EDP Number	Stock
4-40	H4/H5	0.100 - 0.102	4	0.141	0.110	1.882	0.709	2.845	9039400028450	●
5-40	H4/H5	0.114 - 0.116	4	0.141	0.110	1.941	0.709	3.175	9039400031750	●
6-32	H5/H6	0.124 - 0.126	4	0.141	0.110	2.000	0.709	3.505	9039400035050	●
8-32	H5/H6	0.149 - 0.150	4	0.168	0.131	2.130	0.827	4.166	9039400041660	●
10-24	H6/H7	0.171 - 0.173	4	0.194	0.152	2.382	0.945	4.826	9039400048260	●
12-24	H6/H7	0.196 - 0.198	4	0.220	0.165	2.382	1.024	5.486	9039400054860	●
1/4-20	H7/H8	0.225 - 0.228	5	0.255	0.191	2.500	1.181	6.350	9039400063500	●
5/16-18	H8/H9	0.286 - 0.290	5	0.318	0.238	2.721	1.377	7.938	9039400079380	●
3/8-16	H8/H9	0.345 - 0.350	5	0.381	0.286	2.941	1.456	9.525	9039400095250	●
7/16-14	H9/H10	0.404 - 0.408	5	0.323	0.242	3.161	N/A	11.113	9039400111130	●
1/2-13	H10/H11	0.463 - 0.468	5	0.367	0.275	3.382	N/A	12.700	9039400127000	●
9/16-12	H10/H11	0.523 - 0.527	6	0.429	0.322	3.591	N/A	14.288	9039400142880	●
5/8-11	H11/H12	0.582 - 0.587	6	0.480	0.360	3.811	N/A	15.875	9039400158750	●
3/4-10	H12/H13	0.703 - 0.708	6	0.590	0.442	4.252	N/A	19.050	9039400190500	●

UNF

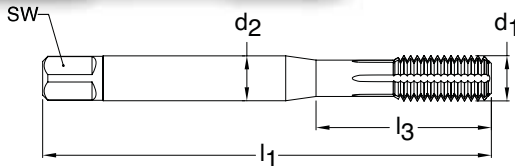

Through holes



Blind holes



TiN coated



External cooling

Series 3941
Standard ANSI
Tool Material HSS-E (Cobalt)
Flute Oil grooves
Chamfer Form C • 2-3
Class of Fit 2BX



d1 - P	H Limits	Tap Drill Range inch	Number of Flutes	d2 inch	SW inch	l1 inch	l3 inch	Order Code	EDP Number	Stock
4-48	H4/H5	0.102 - 0.103	4	0.141	0.110	1.882	0.709	2.845	9039410028450	●
5-44	H4/H5	0.114 - 0.115	4	0.141	0.110	1.941	0.709	3.175	9039410031750	●
6-40	H5/H6	0.126 - 0.128	4	0.141	0.110	2.000	0.709	3.505	9039410035050	●
8-36	H4/H5	0.151 - 0.153	4	0.168	0.131	2.130	0.827	4.166	9039410041660	●
10-32	H5/H6	0.174 - 0.178	4	0.194	0.152	2.382	0.945	4.826	9039410048260	●
12-28	H6/H7	0.198 - 0.202	4	0.220	0.165	2.382	1.024	5.486	9039410054860	●
1/4-28	H6/H7	0.233 - 0.236	5	0.255	0.191	2.500	1.181	6.350	9039410063500	●
5/16-24	H7/H8	0.292 - 0.295	5	0.318	0.238	2.721	1.377	7.938	9039410079380	●
3/8-24	H7/H8	0.355 - 0.358	5	0.381	0.286	2.941	1.456	9.525	9039410095250	●
7/16-20	H8/H9	0.413 - 0.417	5	0.323	0.242	3.161	N/A	11.113	9039410111130	●
1/2-20	H8/H9	0.476 - 0.480	6	0.367	0.275	3.382	N/A	12.700	9039410127000	●
9/16-18	H8/H9	0.535 - 0.540	6	0.429	0.322	3.591	N/A	14.288	9039410142880	●
5/8-18	H9/H10	0.599 - 0.603	6	0.480	0.360	3.811	N/A	15.875	9039410158750	●
3/4-16	H10/H11	0.719 - 0.727	7	0.590	0.442	4.252	N/A	19.050	9039410190500	●

UNC

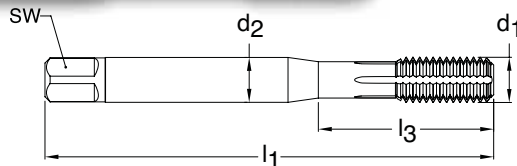

Through holes



Blind holes



TiCN coated



External cooling

Series 3943
Standard ANSI
Tool Material HSS-E (Cobalt)
Flute Oil grooves
Chamfer Form C • 2-3
Class of Fit 2BX



d1 - P	H Limits	Tap Drill Range inch	Number of Flutes	d2 inch	SW inch	l1 inch	l3 inch	Order Code	EDP Number	Stock
4-40	H4/H5	0.100 - 0.102	4	0.141	0.110	1.882	0.709	2.845	9039430028450	●
5-40	H4/H5	0.114 - 0.116	4	0.141	0.110	1.941	0.709	3.175	9039430031750	●
6-32	H5/H6	0.124 - 0.126	4	0.141	0.110	2.000	0.709	3.505	9039430035050	●
8-32	H5/H6	0.149 - 0.150	4	0.168	0.131	2.130	0.827	4.166	9039430041660	●
10-24	H6/H7	0.171 - 0.173	4	0.194	0.152	2.382	0.945	4.826	9039430048260	●
12-24	H6/H7	0.196 - 0.198	4	0.220	0.165	2.382	1.024	5.486	9039430054860	●
1/4-20	H7/H8	0.225 - 0.228	5	0.255	0.191	2.500	1.181	6.350	9039430063500	●
5/16-18	H8/H9	0.286 - 0.290	5	0.318	0.238	2.721	1.377	7.938	9039430079380	●
3/8-16	H8/H9	0.345 - 0.350	5	0.381	0.286	2.941	1.456	9.525	9039430095250	●
7/16-14	H9/H10	0.404 - 0.408	5	0.323	0.242	3.161	N/A	11.113	9039430111130	●
1/2-13	H10/H11	0.463 - 0.468	5	0.367	0.275	3.382	N/A	12.700	9039430127000	●
9/16-12	H10/H11	0.523 - 0.527	6	0.429	0.322	3.591	N/A	14.288	9039430142880	●
5/8-11	H11/H12	0.582 - 0.587	6	0.480	0.360	3.811	N/A	15.875	9039430158750	●
3/4-10	H12/H13	0.703 - 0.708	6	0.590	0.442	4.252	N/A	19.050	9039430190500	●

UNF

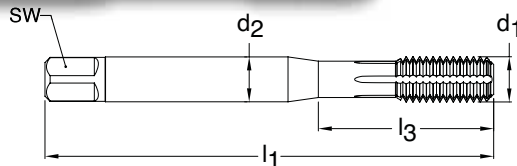

Through holes



Blind holes



TiCN coated



External cooling

Series 3944
Standard ANSI
Tool Material HSS-E (Cobalt)
Flute Oil grooves
Chamfer Form C • 2-3
Class of Fit 2BX

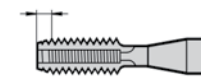

d1 - P	H Limits	Tap Drill Range inch	Number of Flutes	d2 inch	SW inch	l1 inch	l3 inch	Order Code	EDP Number	Stock
4-48	H4/H5	0.102 - 0.103	4	0.141	0.110	1.882	0.709	2.845	9039440028450	●
5-44	H4/H5	0.114 - 0.115	4	0.141	0.110	1.941	0.709	3.175	9039440031750	●
6-40	H5/H6	0.126 - 0.128	4	0.141	0.110	2.000	0.709	3.505	9039440035050	●
8-36	H4/H5	0.151 - 0.153	4	0.168	0.131	2.130	0.827	4.166	9039440041660	●
10-32	H5/H6	0.174 - 0.178	4	0.194	0.152	2.382	0.945	4.826	9039440048260	●
12-28	H6/H7	0.198 - 0.202	4	0.220	0.165	2.382	1.024	5.486	9039440054860	●
1/4-28	H6/H7	0.233 - 0.236	5	0.255	0.191	2.500	1.181	6.350	9039440063500	●
5/16-24	H7/H8	0.292 - 0.295	5	0.318	0.238	2.721	1.377	7.938	9039440079380	●
3/8-24	H7/H8	0.355 - 0.358	5	0.381	0.286	2.941	1.456	9.525	9039440095250	●
7/16-20	H8/H9	0.413 - 0.417	5	0.323	0.242	3.161	N/A	11.113	9039440111130	●
1/2-20	H8/H9	0.476 - 0.480	6	0.367	0.275	3.382	N/A	12.700	9039440127000	●
9/16-18	H8/H9	0.535 - 0.540	6	0.429	0.322	3.591	N/A	14.288	9039440142880	●
5/8-18	H9/H10	0.599 - 0.603	6	0.480	0.360	3.811	N/A	15.875	9039440158750	●
3/4-16	H10/H11	0.719 - 0.727	7	0.590	0.442	4.252	N/A	19.050	9039440190500	●

"Tap drill Range" given is per the Class of Fit shown per Series #
 Additional Tap Drill sizes & percent of thread engagement can be found on pages 238-239.

UNC

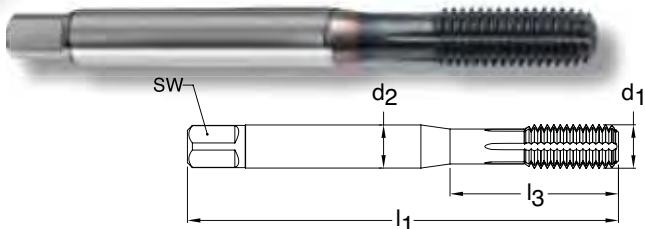

Series 4377
Standard DIN/ANSI
Tool Material HSS-E-PM
Flute Oil grooves
Chamfer Form C • 2-3
Class of Fit 2BX



- Through holes
- Blind holes
- TiCN coated
- External cooling

d1 - P	H Limits	Tap Drill Range inch	Number of Flutes	d2 inch	SW inch	l1 inch	l3 inch	Order Code	EDP Number	Stock
2-56	H3/H4	0.077 - 0.079	3	0.141	0.110	1.772	0.441	2.184	9043770021840	●
3-48	H3/H4	0.089 - 0.913	3	0.141	0.110	1.969	0.500	2.515	9043770025150	●
4-40	H4/H5	0.100 - 0.102	4	0.141	0.110	2.205	0.709	2.845	9043770028450	●
5-40	H4/H5	0.114 - 0.116	4	0.141	0.110	2.205	0.709	3.175	9043770031750	●
6-32	H5/H6	0.124 - 0.126	4	0.141	0.110	2.205	0.709	3.505	9043770035050	●
8-32	H5/H6	0.149 - 0.150	4	0.168	0.131	2.480	0.827	4.166	9043770041660	●
10-24	H6/H7	0.171 - 0.173	4	0.194	0.152	2.756	0.945	4.826	9043770048260	●
12-24	H6/H7	0.196 - 0.198	4	0.220	0.165	3.150	1.024	5.486	9043770054860	●
1/4-20	H7/H8	0.225 - 0.228	5	0.255	0.191	3.150	1.181	6.350	9043770063500	●
5/16-18	H8/H9	0.286 - 0.290	5	0.318	0.238	3.543	1.377	7.938	9043770079380	●
3/8-16	H8/H9	0.345 - 0.350	5	0.381	0.286	3.937	1.456	9.525	9043770095250	●
7/16-14	H9/H10	0.404 - 0.408	5	0.323	0.242	3.937	N/A	11.113	9043770111130	●
1/2-13	H10/H11	0.463 - 0.468	5	0.367	0.275	4.331	N/A	12.700	9043770127000	●
9/16-12	H10/H11	0.523 - 0.527	6	0.429	0.322	4.331	N/A	14.288	9043770142880	●
5/8-11	H11/H12	0.582 - 0.587	6	0.480	0.360	4.331	N/A	15.875	9043770158750	●
3/4-10	H12/H13	0.703 - 0.708	6	0.590	0.442	4.921	N/A	19.050	9043770190500	●
7/8-9	H12/H13	0.825 - 0.831	7	0.697	0.523	5.512	N/A	22.225	9043770222250	●
1-8	H13/H14	0.943 - 0.950	7	0.800	0.600	6.299	N/A	25.400	9043770254000	●

UNF

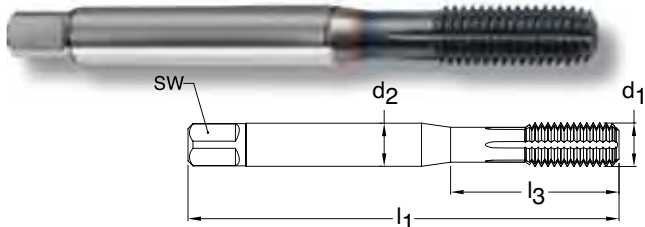

Series 4378
Standard DIN/ANSI
Tool Material HSS-E-PM
Flute Oil grooves
Chamfer Form C • 2-3
Class of Fit 2BX



- Through holes
- Blind holes
- TiCN coated
- External cooling

d1 - P	H Limits	Tap Drill Range inch	Number of Flutes	d2 inch	SW inch	l1 inch	l3 inch	Order Code	EDP Number	Stock
2-64	H3/H4	0.078 - 0.080	3	0.141	0.110	1.772	0.441	2.184	9043780021840	●
3-56	H3/H4	0.090 - 0.092	3	0.141	0.110	1.969	0.500	2.515	9043780025150	●
4-48	H4/H5	0.102 - 0.103	4	0.141	0.110	2.205	0.709	2.845	9043780028450	●
5-44	H4/H5	0.114 - 0.115	4	0.141	0.110	2.205	0.709	3.175	9043780031750	●
6-40	H5/H6	0.126 - 0.128	4	0.141	0.110	2.205	0.748	3.505	9043780035050	●
8-36	H4/H5	0.151 - 0.153	4	0.168	0.131	2.480	0.827	4.166	9043780041660	●
10-32	H5/H6	0.174 - 0.178	4	0.194	0.152	2.756	0.945	4.826	9043780048260	●
12-28	H6/H7	0.198 - 0.202	4	0.220	0.165	3.150	1.024	5.486	9043780054860	●
1/4-28	H6/H7	0.233 - 0.236	5	0.255	0.191	3.150	1.181	6.350	9043780063500	●
5/16-24	H7/H8	0.292 - 0.295	5	0.318	0.238	3.543	1.377	7.938	9043780079380	●
3/8-24	H7/H8	0.355 - 0.358	5	0.381	0.286	3.543	1.456	9.525	9043780095250	●
7/16-20	H8/H9	0.413 - 0.417	5	0.323	0.242	3.937	N/A	11.113	9043780111130	●
1/2-20	H8/H9	0.476 - 0.480	6	0.367	0.275	3.937	N/A	12.700	9043780127000	●
9/16-18	H8/H9	0.535 - 0.540	6	0.429	0.322	3.937	N/A	14.288	9043780142880	●
5/8-18	H9/H10	0.599 - 0.603	6	0.480	0.360	3.937	N/A	15.875	9043780158750	●
3/4-16	H10/H11	0.719 - 0.727	7	0.590	0.442	4.331	N/A	19.050	9043780190500	●
7/8-14	H10/H11	0.840 - 0.846	8	0.697	0.523	4.921	N/A	22.225	9043780222250	●
1-12	H11/H12	0.961 - 0.966	9	0.800	0.600	5.512	N/A	25.400	9043780254000	●

UNC

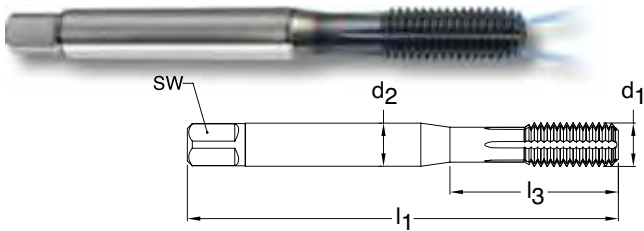

Series 4379
Standard DIN/ANSI
Tool Material HSS-E-PM
Flute Oil grooves
Chamfer Form C • 2-3
Class of Fit 2BX



- Through holes
- Blind holes
- TiCN coated
- Radial coolant

d1 - P	H Limits	Tap Drill Range inch	Number of Flutes	d2 inch	SW inch	l1 inch	l3 inch	Order Code	EDP Number	Stock
10-24	H6/H7	0.171 - 0.173	4	0.194	0.152	2.756	0.945	4.826	9043790048260	●
1/4-20	H7/H8	0.225 - 0.228	5	0.255	0.191	3.150	1.181	6.350	9043790063500	●
5/16-18	H8/H9	0.286 - 0.290	5	0.318	0.238	3.543	1.377	7.938	9043790079380	●
3/8-16	H8/H9	0.345 - 0.350	5	0.381	0.286	3.937	1.456	9.525	9043790095250	●
7/16-14	H9/H10	0.404 - 0.408	5	0.323	0.242	3.937	N/A	11.113	9043790111130	●
1/2-13	H10/H11	0.463 - 0.468	5	0.367	0.275	4.331	N/A	12.700	9043790127000	●
9/16-12	H10/H11	0.523 - 0.527	6	0.429	0.322	4.331	N/A	14.288	9043790142880	●
5/8-11	H11/H12	0.582 - 0.587	6	0.480	0.360	4.331	N/A	15.875	9043790158750	●
3/4-10	H12/H13	0.703 - 0.708	6	0.590	0.442	4.921	N/A	19.050	9043790190500	●

UNF

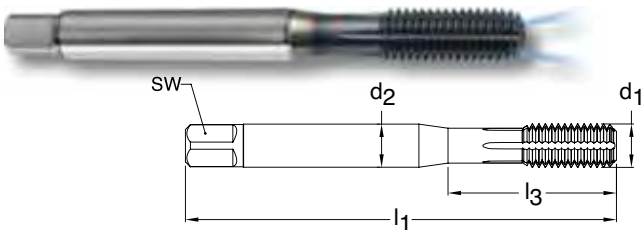

Series 4380
Standard DIN/ANSI
Tool Material HSS-E-PM
Flute Oil grooves
Chamfer Form C • 2-3
Class of Fit 2BX



- Through holes
- Blind holes
- TiCN coated
- Radial coolant

d1 - P	H Limits	Tap Drill Range inch	Number of Flutes	d2 inch	SW inch	l1 inch	l3 inch	Order Code	EDP Number	Stock
10-32	H5/H6	0.174 - 0.178	4	0.194	0.152	2.756	0.945	4.826	9043800048260	●
1/4-28	H6/H7	0.233 - 0.236	5	0.255	0.191	3.150	1.181	6.350	9043800063500	●
5/16-24	H7/H8	0.292 - 0.295	5	0.318	0.238	3.543	1.377	7.938	9043800079380	●
3/8-24	H7/H8	0.355 - 0.358	5	0.381	0.286	3.543	1.456	9.525	9043800095250	●
7/16-20	H8/H9	0.413 - 0.417	5	0.323	0.242	3.937	N/A	11.113	9043800111130	●
1/2-20	H8/H9	0.476 - 0.480	6	0.367	0.275	3.937	N/A	12.700	9043800127000	●
9/16-18	H8/H9	0.535 - 0.540	6	0.429	0.322	3.937	N/A	14.288	9043800142880	●
5/8-18	H9/H10	0.599 - 0.603	6	0.480	0.360	3.937	N/A	15.875	9043800158750	●
3/4-16	H10/H11	0.719 - 0.727	7	0.590	0.442	4.331	N/A	19.050	9043800190500	●

"Tap drill Range" given is per the Class of Fit shown per Series #
 Additional Tap Drill sizes & percent of thread engagement can be found on pages 238-239.

UNC

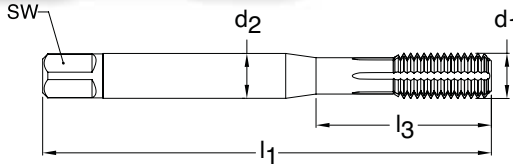

Through holes



Blind holes



TiN coated



External cooling

Chamfer Form E • 1.5-2

Series 3959
Standard ANSI
Tool Material HSS-E (Cobalt)
Flute Oil grooves



Class of Fit 2BX

d1 - P	H Limits	Tap Drill Range inch	Number of Flutes	d2 inch	SW inch	l1 inch	l3 inch	Order Code	EDP Number	Stock
4-40	H4/H5	0.100 - 0.102	4	0.141	0.110	1.882	0.709	2.845	9039590028450	●
6-32	H5/H6	0.124 - 0.126	4	0.141	0.110	2.000	0.709	3.505	9039590035050	●
8-32	H5/H6	0.149 - 0.150	4	0.168	0.131	2.130	0.827	4.166	9039590041660	●
10-24	H6/H7	0.171 - 0.173	4	0.194	0.152	2.382	0.945	4.826	9039590048260	●
1/4-20	H7/H8	0.225 - 0.228	5	0.255	0.191	2.500	1.181	6.350	9039590063500	●
5/16-18	H8/H9	0.286 - 0.290	5	0.318	0.238	2.721	1.377	7.938	9039590079380	●
3/8-16	H8/H9	0.345 - 0.350	5	0.381	0.286	2.941	1.456	9.525	9039590095250	●
7/16-14	H9/H10	0.404 - 0.408	5	0.323	0.242	3.161	N/A	11.113	9039590111130	●
1/2-13	H10/H11	0.463 - 0.468	5	0.367	0.275	3.382	N/A	12.700	9039590127000	●
9/16-12	H10/H11	0.535 - 0.540	6	0.429	0.322	3.591	N/A	14.288	9039590142880	●
5/8-11	H11/H12	0.582 - 0.587	6	0.480	0.360	3.811	N/A	15.875	9039590158750	●

UNF

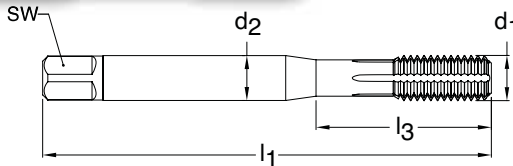

Through holes



Blind holes



TiN coated



External cooling

Chamfer Form E • 1.5-2

Series 3972
Standard ANSI
Tool Material HSS-E (Cobalt)
Flute Oil grooves



Class of Fit 2BX

d1 - P	H Limits	Tap Drill Range inch	Number of Flutes	d2 inch	SW inch	l1 inch	l3 inch	Order Code	EDP Number	Stock
4-48	H4/H5	0.102 - 0.103	4	0.141	0.110	1.882	0.709	2.845	9039720028450	●
5-44	H4/H5	0.114 - 0.115	4	0.141	0.110	1.941	0.709	3.175	9039720031750	●
6-40	H5/H6	0.126 - 0.128	4	0.141	0.110	2.000	0.709	3.505	9039720035050	●
8-36	H4/H5	0.151 - 0.153	4	0.168	0.131	2.130	0.827	4.166	9039720041660	●
10-32	H5/H6	0.174 - 0.178	4	0.194	0.152	2.382	0.945	4.826	9039720048260	●
1/4-28	H6/H7	0.233 - 0.236	5	0.255	0.191	2.500	1.181	6.350	9039720063500	●
5/16-24	H7/H8	0.292 - 0.295	5	0.318	0.238	2.721	1.377	7.938	9039720079380	●
3/8-24	H7/H8	0.355 - 0.358	5	0.381	0.286	2.941	1.456	9.525	9039720095250	●
7/16-20	H8/H9	0.413 - 0.417	5	0.323	0.242	3.161	N/A	11.113	9039720111130	●
1/2-20	H8/H9	0.476 - 0.480	6	0.367	0.275	3.382	N/A	12.700	9039720127000	●
9/16-18	H8/H9	0.535 - 0.540	6	0.429	0.322	3.591	N/A	14.288	9039720142880	●
5/8-18	H9/H10	0.599 - 0.603	6	0.480	0.360	3.811	N/A	15.875	9039720158750	●

UNC

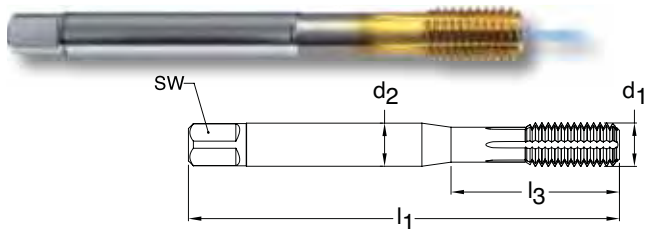

Through holes



Blind holes



TiN coated



Axial coolant



Series 4383
Standard DIN/ANSI
Tool Material HSS-E-PM
Flute Oil grooves



Chamfer Form E • 1.5 - 2

Class of Fit 2BX



d1 - P	H Limits	Tap Drill Range inch	Number of Flutes	d2 inch	SW inch	l1 inch	l3 inch	Order Code	EDP Number	Stock
10-24	H6/H7	0.171 - 0.173	4	0.194	0.152	2.756	0.945	4.826	9043830048260	●
1/4-20	H7/H8	0.225 - 0.228	5	0.255	0.191	3.150	1.181	6.350	9043830063500	●
5/16-18	H8/H9	0.286 - 0.290	5	0.318	0.238	3.543	1.377	7.938	9043830079380	●
3/8-16	H8/H9	0.345 - 0.350	5	0.381	0.286	3.937	1.456	9.525	9043830095250	●
7/16-14	H9/H10	0.404 - 0.408	5	0.323	0.286	3.937	N/A	11.113	9043830111130	●
1/2-13	H10/H11	0.463 - 0.468	5	0.367	0.286	4.331	N/A	12.700	9043830127000	●
9/16-12	H10/H11	0.523 - 0.527	6	0.429	0.286	4.331	N/A	14.288	9043830142880	●
5/8-11	H11/H12	0.582 - 0.587	6	0.480	0.286	4.331	N/A	15.875	9043830158750	●
3/4-10	H12/H13	0.703 - 0.708	6	0.590	0.286	4.921	N/A	19.050	9043830190500	●

UNF

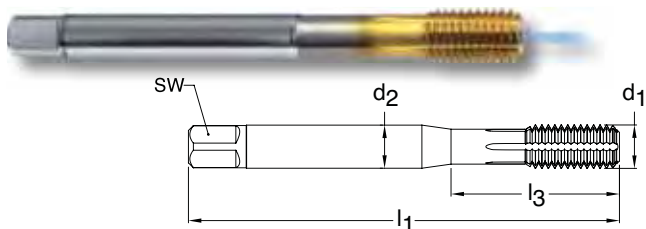

Through holes



Blind holes



TiN coated



Axial coolant



Series 4382
Standard DIN/ANSI
Tool Material HSS-E-PM
Flute Oil grooves



Chamfer Form E • 1.5 - 2

Class of Fit 2BX



d1 - P	H Limits	Tap Drill Range inch	Number of Flutes	d2 inch	SW inch	l1 inch	l3 inch	Order Code	EDP Number	Stock
10-32	H5/H6	0.174 - 0.178	4	0.194	0.152	2.756	0.945	4.826	9043820048260	●
1/4-28	H6/H7	0.233 - 0.236	5	0.255	0.191	3.150	1.181	6.350	9043820063500	●
5/16-24	H7/H8	0.292 - 0.295	5	0.318	0.238	3.543	1.377	7.938	9043820079380	●
3/8-24	H7/H8	0.355 - 0.358	5	0.381	0.286	3.543	1.456	9.525	9043820095250	●
7/16-20	H8/H9	0.413 - 0.417	5	0.323	0.242	3.937	N/A	11.113	9043820111130	●
1/2-20	H8/H9	0.476 - 0.480	6	0.367	0.275	3.937	N/A	12.700	9043820127000	●
9/16-18	H8/H9	0.535 - 0.540	6	0.429	0.322	3.937	N/A	14.288	9043820142880	●
5/8-18	H9/H10	0.599 - 0.603	6	0.480	0.360	3.937	N/A	15.875	9043820158750	●
3/4-16	H10/H11	0.719 - 0.727	7	0.590	0.442	4.331	N/A	19.050	9043820190500	●

"Tap drill Range" given is per the Class of Fit shown per Series #
 Additional Tap Drill sizes & percent of thread engagement can be found on pages 238-239.

UNC

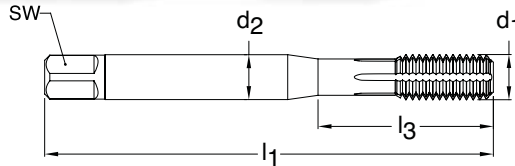

Through holes



Blind holes



TiN coated



External cooling

Series 1582
Standard DIN 371
Tool Material HSS-E (Cobalt)
Flute Oil grooves
Chamfer Form C • 2-3
Class of Fit 2BX

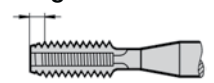

d1 - P	H Limits	Tap Drill Range inch	Number of Flutes	d2 mm	SW mm	l1 mm	l3 mm	Order Code	EDP Number	Stock
10-24	H6/H7	0.171 - 0.173	4	6.00	4.90	70.00	25.00	4.826	9015820048260	●
1/4-20	H7/H8	0.225 - 0.228	4	7.00	5.50	80.00	30.00	6.350	9015820063500	●
5/16-18	H8/H9	0.286 - 0.290	5	8.00	6.20	90.00	35.00	7.938	9015820079380	●
3/8-16	H8/H9	0.345 - 0.350	5	10.00	8.00	100.00	39.00	9.525	9015820095250	●

UNC

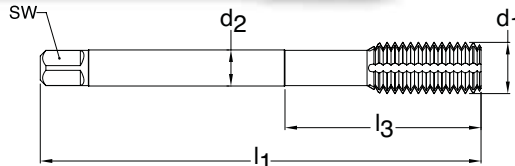

Through holes



Blind holes



TiN coated



External cooling

Series 1583
Standard DIN 376
Tool Material HSS-E (Cobalt)
Flute Oil grooves
Chamfer Form C • 2-3
Class of Fit 2BX



d1 - P	H Limits	Tap Drill Range inch	Number of Flutes	d2 mm	SW mm	l1 mm	l3 mm	Order Code	EDP Number	Stock
1/2-13	H10/H11	0.463 - 0.468	6	9.00	7.00	110.00	N/A	12.700	9015830127000	●
5/8-11	H11/H12	0.582 - 0.587	6	12.00	9.00	110.00	N/A	15.875	9015830158750	○
3/4-10	H12/H13	0.703 - 0.707	6	14.00	11.00	125.00	N/A	19.050	9015830190500	○

UNF

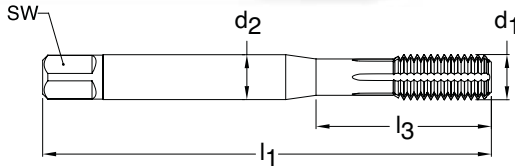

Through holes



Blind holes



TiN coated



External cooling

Series 1584
Standard DIN 371
Tool Material HSS-E (Cobalt)
Flute Oil grooves
Chamfer Form C • 2-3
Class of Fit 2BX



d1 - P	H Limits	Tap Drill Range inch	Number of Flutes	d2 mm	SW mm	l1 mm	l3 mm	Order Code	EDP Number	Stock
10-32	H5/H6	0.174 - 0.178	4	6.00	4.90	70.00	25.00	4.826	9015840048260	○
1/4-28	H6/H7	0.233 - 0.236	4	7.00	5.50	80.00	30.00	6.350	9015840063500	○
5/16-24	H7/H8	0.292 - 0.295	5	8.00	6.20	90.00	35.00	7.938	9015840079380	○
3/8-24	H7/H8	0.355 - 0.358	5	10.00	8.00	90.00	35.00	9.525	9015840095250	○

UNF

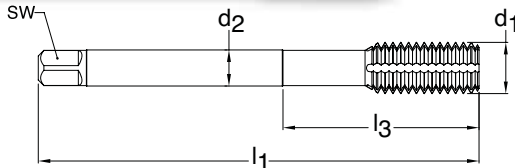

Through holes



Blind holes



TiN coated



External cooling

Series 1585
Standard DIN 374
Tool Material HSS-E (Cobalt)
Flute Oil grooves
Chamfer Form C • 2-3
Class of Fit 2BX



d1 - P	H Limits	Tap Drill Range inch	Number of Flutes	d2 mm	SW mm	l1 mm	l3 mm	Order Code	EDP Number	Stock
7/16-20	H8/H9	0.413 - 0.417	5	8.00	6.20	100.00	N/A	11.113	9015850111130	●
1/2-20	H8/H9	0.476 - 0.480	6	9.00	7.00	100.00	N/A	12.700	9015850127000	●
9/16-18	H8/H9	0.535 - 0.540	6	11.00	9.00	100.00	N/A	14.288	9015850142880	○
5/8-18	H9/H10	0.599 - 0.603	6	12.00	9.00	100.00	N/A	15.875	9015850158750	○
3/4-16	H10/H11	0.720 - 0.725	7	14.00	11.00	110.00	N/A	19.050	9015850190500	○

METRIC

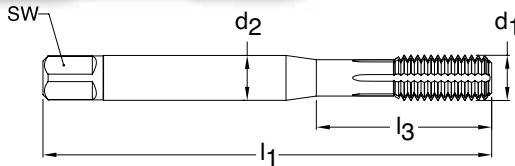

Through holes



Blind holes



TiN coated



External cooling

Series 3939
Standard ANSI
Tool Material HSS-E (Cobalt)
Flute Oil grooves
Chamfer Form C • 2-3
Class of Fit 6HX



d1 - P	D Limits	Tap Drill Range mm	Number of Flutes	d2 inch	SW inch	l1 inch	l3 inch	Order Code	EDP Number	Stock
M2 X 0.40	D4/D5	1.830 - 1.870	3	0.141	0.110	1.752	0.441	2.000	9039390020000	●
M3 X 0.50	D5/D6	2.780 - 2.840	4	0.141	0.110	1.941	0.709	3.000	9039390030000	●
M4 X 0.70	D6/D7	3.670 - 3.760	4	0.168	0.131	2.130	0.827	4.000	9039390040000	●
M5 X 0.80	D7/D8	4.620 - 4.680	4	0.194	0.152	2.382	0.945	5.000	9039390050000	●
M6 X 1.00	D8/D9	5.520 - 5.600	5	0.255	0.191	2.500	1.181	6.000	9039390060000	●
M8 X 1.25	D9/D10	7.390 - 7.470	5	0.318	0.238	2.721	1.377	8.000	9039390080000	●
M10 X 1.50	D10/D11	9.290 - 9.370	5	0.381	0.286	2.941	1.456	10.000	9039390100000	●
M12 X 1.75	D11/D12	11.180 - 11.280	5	0.367	0.275	3.382	N/A	12.000	9039390120000	●
M14 X 2.00	D13/D14	13.070 - 13.160	6	0.429	0.322	3.591	N/A	14.000	9039390140000	●
M16 X 2.00	D13/D14	15.070 - 15.160	6	0.480	0.360	3.811	N/A	16.000	9039390160000	●

METRIC FINE

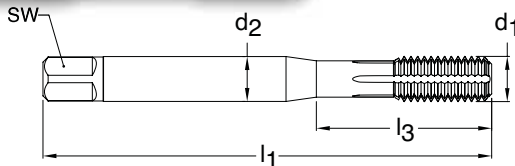

Through holes



Blind holes



TiN coated



External cooling

Series 3975
Standard ANSI
Tool Material HSS-E (Cobalt)
Flute Oil grooves
Chamfer Form C • 2-3
Class of Fit 6HX



d1 - P	D Limits	Tap Drill Range mm	Number of Flutes	d2 inch	SW inch	l1 inch	l3 inch	Order Code	EDP Number	Stock
M6 X 0.75	D6/D7	5.620 - 5.700	5	0.255	0.191	2.500	1.181	6.004	9039750060040	●
M8 X 1.00	D7/D8	7.520 - 7.620	5	0.318	0.238	2.721	1.377	8.005	9039750080050	●
M10 X 1.00	D7/D8	9.520 - 9.620	5	0.381	0.286	2.941	1.456	10.005	9039750100050	●
M10 X 1.25	D7/D8	9.360 - 9.470	5	0.381	0.286	2.941	1.456	10.006	9039750100060	●
M12 X 1.00	D7/D8	11.520 - 11.620	6	0.367	0.275	3.382	N/A	12.005	9039750120050	●
M12 X 1.25	D7/D8	11.360 - 11.470	6	0.367	0.275	3.382	N/A	12.006	9039750120060	●
M12 X 1.50	D8/D9	11.260 - 11.380	6	0.367	0.275	3.382	N/A	12.007	9039750120070	●
M14 X 1.25	D9/D10	13.360 - 13.470	6	0.429	0.322	3.591	N/A	14.006	9039750140060	●
M14 X 1.50	D10/D11	13.260 - 13.380	6	0.429	0.322	3.591	N/A	14.007	9039750140070	●
M16 X 1.50	D10/D11	15.260 - 15.380	6	0.480	0.360	3.811	N/A	16.007	9039750160070	●
M18 X 1.50	D10/D11	17.260 - 17.380	6	0.542	0.406	4.032	N/A	18.007	9039750180070	●
M20 X 1.50	D11/D12	19.260 - 19.380	7	0.652	0.489	4.469	N/A	20.007	9039750200070	●

METRIC

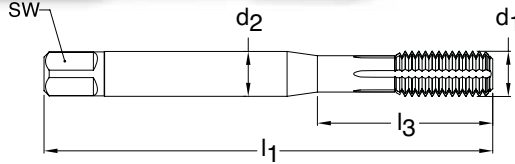

Series 3942
Standard ANSI
Tool Material HSS-E (Cobalt)
Flute Oil grooves
Chamfer Form C • 2-3
Class of Fit 6HX



Through holes **Blind holes** **TiCN coated** **External cooling**

d1 - P	D Limits	Tap Drill Range mm	Number of Flutes	d2 inch	SW inch	l1 inch	l3 inch	Order Code	EDP Number	Stock
M3 X 0.50	D5/D6	2.780 - 2.840	4	0.141	0.110	1.941	0.709	3.000	9039420030000	●
M4 X 0.70	D6/D7	3.670 - 3.760	4	0.168	0.131	2.130	0.827	4.000	9039420040000	●
M5 X 0.80	D7/D8	4.620 - 4.680	4	0.194	0.152	2.382	0.945	5.000	9039420050000	●
M6 X 1.00	D8/D9	5.520 - 5.600	5	0.255	0.191	2.500	1.181	6.000	9039420060000	●
M8 X 1.25	D9/D10	7.390 - 7.470	5	0.318	0.238	2.721	1.377	8.000	9039420080000	●
M10 X 1.50	D10/D11	9.290 - 9.370	5	0.381	0.286	2.941	1.456	10.000	9039420100000	●
M12 X 1.75	D11/D12	11.180 - 11.280	5	0.367	0.275	3.382	N/A	12.000	9039420120000	●
M14 X 2.00	D13/D14	13.070 - 13.160	6	0.429	0.322	3.591	N/A	14.000	9039420140000	●
M16 X 2.00	D13/D14	15.070 - 15.160	6	0.480	0.360	3.811	N/A	16.000	9039420160000	●

METRIC

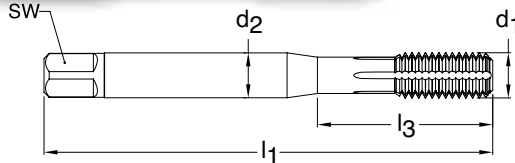

Series 3979
Standard ANSI
Tool Material HSS-E (Cobalt)
Flute Oil grooves
Chamfer Form E • 1.5-2
Class of Fit 6HX



Through holes **Blind holes** **TiN coated** **External cooling**

d1 - P	D Limits	Tap Drill Range mm	Number of Flutes	d2 inch	SW inch	l1 inch	l3 inch	Order Code	EDP Number	Stock
M3 X 0.50	D5/D6	2.780 - 2.840	4	0.141	0.110	1.941	0.709	3.000	9039790030000	●
M4 X 0.70	D6/D7	3.670 - 3.760	4	0.168	0.131	2.130	0.827	4.000	9039790040000	●
M5 X 0.80	D7/D8	4.620 - 4.680	4	0.194	0.152	2.382	0.945	5.000	9039790050000	●
M6 X 1.00	D8/D9	5.520 - 5.600	5	0.255	0.191	2.500	1.181	6.000	9039790060000	●
M8 X 1.25	D9/D10	7.390 - 7.470	5	0.318	0.238	2.721	1.377	8.000	9039790080000	●
M10 X 1.50	D10/D11	9.290 - 9.370	5	0.381	0.286	2.941	1.456	10.000	9039790100000	●
M12 X 1.75	D11/D12	11.180 - 11.280	5	0.367	0.275	3.382	N/A	12.000	9039790120000	●
M14 X 2.00	D13/D14	13.070 - 13.160	6	0.429	0.322	3.591	N/A	14.000	9039790140000	●
M16 X 2.00	D13/D14	15.070 - 15.160	6	0.480	0.360	3.811	N/A	16.000	9039790160000	●

METRIC

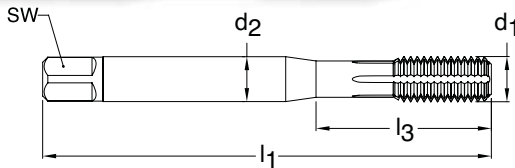

Through holes

Blind holes

TiN coated

External cooling

Series 919
Standard DIN 371
Tool Material HSS-E (Cobalt)
Flute Oil grooves
Chamfer Form C • 2-3
Class of Fit 6HX

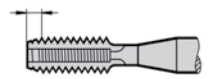

d1 - P	D Limits	Tap Drill Range mm	Number of Flutes	d2 mm	SW mm	l1 mm	l3 mm	Order Code	EDP Number	Stock
M3 X 0.50	D5/D6	2.780 - 2.840	4	3.50	2.70	56.00	18.00	3.000	9009190030000	●
M3.5 X 0.60	D6/D7	3.220 - 3.280	4	4.00	3.00	56.00	20.00	3.500	9009190035000	○
M4 X 0.70	D6/D7	3.670 - 3.760	4	4.50	3.40	63.00	21.00	4.000	9009190040000	●
M5 X 0.80	D7/D8	4.620 - 4.680	4	6.00	4.90	70.00	25.00	5.000	9009190050000	●
M6 X 1.00	D8/D9	5.520 - 5.600	4	6.00	4.90	80.00	30.00	6.000	9009190060000	●
M8 X 1.25	D9/D10	7.390 - 7.470	5	8.00	6.20	90.00	35.00	8.000	9009190080000	●
M10 X 1.50	D10/D11	9.290 - 9.370	5	10.00	8.00	100.00	39.00	10.000	9009190100000	●

METRIC

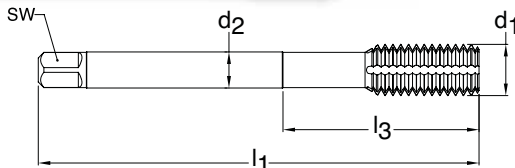

Through holes

Blind holes

TiN coated

Axial coolant

Series 923
Standard DIN 376
Tool Material HSS-E (Cobalt)
Flute Oil grooves
Chamfer Form C • 2-3
Class of Fit 6HX

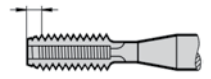

d1 - P	D Limits	Tap Drill Range mm	Number of Flutes	d2 mm	SW mm	l1 mm	l3 mm	Order Code	EDP Number	Stock
M 6 X 1.00	D8/D9	5.520 - 5.600	4	4.50	3.40	80.00	N/A	6.000	9009230060000	●
M 8 X 1.25	D9/D10	7.390 - 7.470	5	6.00	4.90	90.00	N/A	8.000	9009230080000	●
M10 X 1.50	D10/D11	9.290 - 9.370	5	7.00	5.50	100.00	N/A	10.000	9009230100000	●
M12 X 1.75	D11/D12	11.180 - 11.280	5	9.00	7.00	110.00	N/A	12.000	9009230120000	●
M14 X 2.00	D13/D14	13.070 - 13.160	6	11.00	9.00	110.00	N/A	14.000	9009230140000	○
M16 X 2.00	D13/D14	15.070 - 15.160	6	12.00	9.00	110.00	N/A	16.000	9009230160000	●
M18 X 2.50	D13/D14	16.850 - 17.000	6	14.00	11.00	125.00	N/A	18.000	9009230180000	○
M20 X 2.50	D14/D15	18.850 - 19.000	7	16.00	12.00	140.00	N/A	20.000	9009230200000	○
M22 X 2.50	D14/D15	20.850 - 21.000	7	18.00	14.50	140.00	N/A	22.000	9009230220000	○
M24 X 3.00	D15/D16	22.620 - 22.800	7	18.00	14.50	160.00	N/A	24.000	9009230240000	○
M27 X 3.00	D15/D16	25.620 - 25.800	7	20.00	16.00	160.00	N/A	27.000	9009230270000	○
M30 X 3.50	D16/D17	28.400 - 28.600	9	22.00	18.00	180.00	N/A	30.000	9009230300000	○
M33 X 3.50	D16/D17	31.400 - 31.600	9	25.00	20.00	180.00	N/A	33.000	9009230330000	○
M36 X 4.00	D17/D18	34.170 - 34.400	9	28.00	22.00	200.00	N/A	36.000	9009230360000	○
M39 X 4.00	D17/D18	37.170 - 37.400	9	32.00	24.00	200.00	N/A	39.000	9009230390000	○

METRIC - MICRO

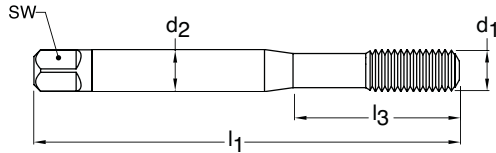

Series 921*
Standard DIN 371
Tool Material HSS-E (Cobalt)
Flute None
Chamfer Form C • 2-3
Class of Fit 6HX



Through holes

Blind holes

TiN coated

External cooling

d1 - P	D Limits	Tap Drill Range mm	Number of Flutes*	d2 mm	SW mm	l1 mm	l3 mm	Order Code	EDP Number	Stock
M1 x 0.25	D4/D5	0.890 - 0.920	-	2.50	2.10	40.00	4.00	1.000	9009210010000	
M1.2 x 0.25	D4/D5	1.090 - 1.120	-	2.50	2.10	40.00	4.80	1.200	9009210012000	
M1.4 x 0.30	D4/D5	1.270 - 1.300	-	2.50	2.10	40.00	5.60	1.400	9009210014000	
M1.6 x 0.35	D4/D5	1.450 - 1.480	-	2.50	2.10	40.00	6.40	1.600	9009210016000	
M1.7 x 0.35	D4/D5	1.550 - 1.580	-	2.50	2.10	40.00	6.80	1.700	9009210017000	
M1.8 x 0.35	D4/D5	1.650 - 1.680	-	2.50	2.10	40.00	7.30	1.800	9009210018000	
M2 x 0.40	D4/D5	1.840 - 1.880	-	2.80	2.10	45.00	13.50	2.000	9009210020000	
M2.5 x 0.45	D4/D5	2.280 - 2.320	-	2.80	2.10	50.00	14.50	2.500	9009210025000	
M3 x 0.50	D5/D6	2.780 - 2.850	-	3.50	2.70	56.00	18.00	3.000	9009210030000	
M3.5 x 0.60	D5/D6	3.230 - 3.300	-	4.00	3.00	56.00	20.00	3.500	9009210035000	
M4 x 0.70	D6/D7	3.680 - 3.760	-	4.50	3.40	63.00	21.00	4.000	9009210040000	
M5 x 0.80	D7/D8	4.620 - 4.710	-	6.00	4.90	70.00	25.00	5.000	9009210050000	
M6 x 1.00	D8/D9	5.520 - 5.620	-	6.00	4.90	80.00	30.00	6.000	9009210060000	
M8 x 1.25	D9/D10	7.360 - 7.470	-	8.00	6.20	90.00	35.00	8.000	9009210080000	
M10 x 1.50	D10/D11	9.260 - 9.380	-	10.00	8.00	100.00	39.00	10.000	9009210100000	

*This tap series is manufactured without lubrication grooves.

METRIC FINE

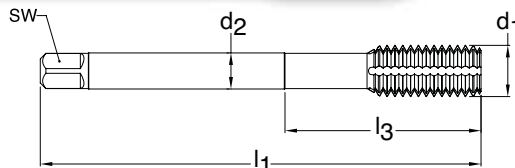

Series 927
Standard DIN 374
Tool Material HSS-E (Cobalt)
Flute Oil grooves
Chamfer Form C • 2-3
Class of Fit 6HX



Through holes

Blind holes

TiN coated

External cooling

d1 - P	D Limits	Tap Drill Range mm	Number of Flutes	d2 mm	SW mm	l1 mm	l3 mm	Order Code	EDP Number	Stock
M6 X 0.75	D6/D7	5.620 - 5.700	4	4.50	3.40	80.00	N/A	6.004	9009270060040	●
M8 X 0.75	D7/D8	7.620 - 7.700	5	6.00	4.90	80.00	N/A	8.004	9009270080040	○
M8 X 1.00	D7/D8	7.520 - 7.620	5	6.00	4.90	90.00	N/A	8.005	9009270080050	●
M10 X 1.00	D7/D8	9.520 - 9.620	5	7.00	5.50	90.00	N/A	10.005	9009270100050	○
M10 X 1.25	D7/D8	9.360 - 9.470	5	7.00	5.50	100.00	N/A	10.006	9009270100060	●
M12 X 1.00	D7/D8	11.520 - 11.620	6	9.00	7.00	100.00	N/A	12.005	9009270120050	●
M12 X 1.25	D7/D8	11.360 - 11.470	6	9.00	7.00	100.00	N/A	12.006	9009270120060	●
M12 X 1.50	D8/D9	11.260 - 11.380	6	9.00	7.00	100.00	N/A	12.007	9009270120070	●
M14 X 1.00	D8/D9	13.520 - 13.620	6	11.00	9.00	100.00	N/A	14.005	9009270140050	○
M14 X 1.50	D10/D11	13.260 - 13.380	6	11.00	9.00	100.00	N/A	14.007	9009270140070	●
M16 X 1.00	D10/D11	15.520 - 15.620	6	12.00	9.00	100.00	N/A	16.005	9009270160050	○
M16 X 1.50	D10/D11	15.260 - 15.380	6	12.00	9.00	100.00	N/A	16.007	9009270160070	●
M18 X 1.00	D10/D11	17.520 - 17.620	6	14.00	11.00	110.00	N/A	18.005	9009270180050	○
M18 X 1.50	D10/D11	17.260 - 17.380	6	14.00	11.00	110.00	N/A	18.007	9009270180070	●
M20 X 1.00	D11/D12	19.520 - 19.620	7	16.00	12.00	125.00	N/A	20.005	9009270200050	○
M20 X 1.50	D11/D12	19.260 - 19.380	7	16.00	12.00	125.00	N/A	20.007	9009270200070	●
M22 X 1.50	D11/D12	21.260 - 21.440	7	18.00	14.50	125.00	N/A	22.007	9009270220070	●
M24 X 1.50	D11/D12	23.260 - 23.380	8	18.00	14.50	140.00	N/A	24.007	9009270240070	○

"Tap drill Range" given is per the Class of Fit shown per Series #
 Additional Tap Drill sizes & percent of thread engagement can be found on pages 238-239.

METRIC

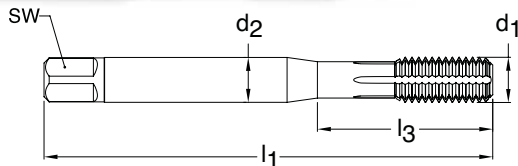

Through holes



Blind holes



TiN coated



Radial coolant

Series 323
Standard DIN 371
Tool Material HSS-E PM
Flute Oil grooves
Chamfer Form C • 2-3
Class of Fit 6HX



d1 - P	D Limits	Tap Drill Range mm	Number of Flutes	d2 mm	SW mm	l1 mm	l3 mm	Order Code	EDP Number	Stock
M5 X 0.80	D7/D8	4.620 - 4.680	4	6.00	4.90	70.00	25.00	5.000	9003230050000	●
M6 X 1.00	D8/D9	5.520 - 5.600	4	6.00	4.90	80.00	30.00	6.000	9003230060000	●
M8 X 1.25	D9/D10	7.390 - 7.470	5	8.00	6.20	90.00	35.00	8.000	9003230080000	●
M10 X 1.50	D10/D11	9.290 - 9.370	5	10.00	8.00	100.00	39.00	10.000	9003230100000	●

METRIC

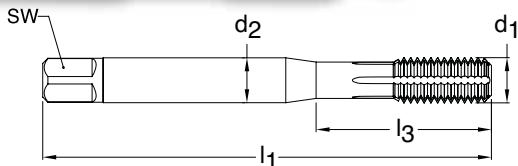

Through holes



Blind holes



TiAlN coated



Radial coolant

Series 1717
Standard DIN 371
Tool Material HSS-E PM
Flute Oil grooves
Chamfer Form C • 2-3
Class of Fit 6HX



d1 - P	D Limits	Tap Drill Range mm	Number of Flutes	d2 mm	SW mm	l1 mm	l3 mm	Order Code	EDP Number	Stock
M5 X 0.80	D7/D8	4.620 - 4.680	4	6.00	4.90	70.00	25.00	5.000	9017170050000	●
M6 X 1.00	D8/D9	5.520 - 5.600	4	6.00	4.90	80.00	30.00	6.000	9017170060000	○
M8 X 1.25	D9/D10	7.390 - 7.470	5	8.00	6.20	90.00	35.00	8.000	9017170080000	●
M10 X 1.50	D10/D11	9.290 - 9.370	5	10.00	8.00	100.00	39.00	10.000	9017170100000	●

METRIC

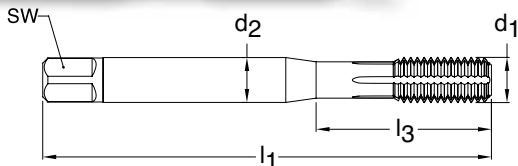

Through holes



Blind holes



TiCN coated



Radial coolant

Series 1270
Standard DIN 371
Tool Material HSS-E PM
Flute Oil grooves
Chamfer Form C • 2-3
Class of Fit 6HX

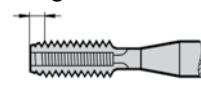

d1 - P	D Limits	Tap Drill Range mm	Number of Flutes	d2 mm	SW mm	l1 mm	l3 mm	Order Code	EDP Number	Stock
M5 X 0.80	D7/D8	4.620 - 4.680	4	6.00	4.90	70.00	25.00	5.000	9012700050000	●
M6 X 1.00	D8/D9	5.520 - 5.600	4	6.00	4.90	80.00	30.00	6.000	9012700060000	●
M8 X 1.25	D9/D10	7.390 - 7.470	5	8.00	6.20	90.00	35.00	8.000	9012700080000	●
M10 X 1.50	D10/D11	9.290 - 9.370	5	10.00	8.00	100.00	39.00	10.000	9012700100000	●

METRIC

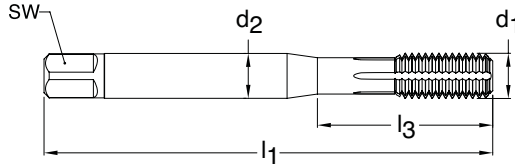

Series 342
Standard DIN 376
Tool Material HSS-E PM
Flute Oil grooves
Chamfer Form C • 2-3
Class of Fit 6HX

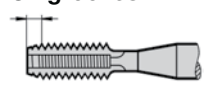

Through holes **Blind holes** **TiN coated** **Radial coolant**

d1 - P	D Limits	Tap Drill Range mm	Number of Flutes	d2 mm	SW mm	l1 mm	l3 mm	Order Code	EDP Number	Stock
M12 X 1.75	D11/D12	11.180 - 11.280	5	9.00	7.00	110.00	N/A	12.000	9003420120000	●
M14 X 2.00	D13/D14	13.070 - 13.160	6	11.00	9.00	110.00	N/A	14.000	9003420140000	●
M16 X 2.00	D13/D14	15.070 - 15.160	6	12.00	9.00	110.00	N/A	16.000	9003420160000	●

METRIC

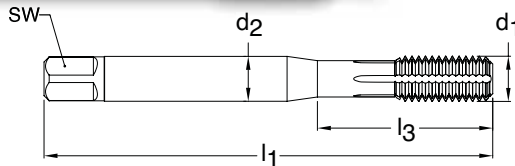

Series 1719
Standard DIN 376
Tool Material HSS-E PM
Flute Oil grooves
Chamfer Form C • 2-3
Class of Fit 6HX



Through holes **Blind holes** **TiAlN coated** **Radial coolant**

d1 - P	D Limits	Tap Drill Range mm	Number of Flutes	d2 mm	SW mm	l1 mm	l3 mm	Order Code	EDP Number	Stock
M12 X 1.75	D11/D12	11.180 - 11.280	5	9.00	7.00	110.00	N/A	12.000	9017190120000	○
M16 X 2.00	D13/D14	15.070 - 15.160	6	12.00	9.00	110.00	N/A	16.000	9017190160000	○
M20 X 2.50	D14/D15	18.850 - 19.000	7	16.00	12.00	140.00	N/A	20.000	9017190200000	●

METRIC

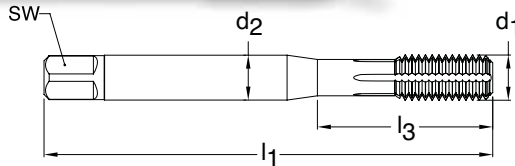

Series 1271
Standard DIN 376
Tool Material HSS-E PM
Flute Oil grooves
Chamfer Form C • 2-3
Class of Fit 6HX

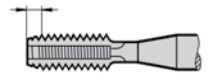

Through holes **Blind holes** **TiCN coated** **Radial coolant**

d1 - P	D Limits	Tap Drill Range mm	Number of Flutes	d2 mm	SW mm	l1 mm	l3 mm	Order Code	EDP Number	Stock
M12 X 1.75	D11/D12	11.180 - 11.280	5	9.00	7.00	110.00	N/A	12.000	9012710120000	●
M16 X 2.00	D13/D14	15.070 - 15.160	6	12.00	9.00	110.00	N/A	16.000	9012710160000	○
M18 X 2.50	D14/D15	16.850 - 17.000	6	14.00	11.00	125.00	N/A	18.000	9012710180000	○
M20 X 2.50	D14/D15	18.850 - 19.000	7	16.00	12.00	140.00	N/A	20.000	9012710200000	○

"Tap drill Range" given is per the Class of Fit shown per Series #
 Additional Tap Drill sizes & percent of thread engagement can be found on pages 238-239.

METRIC FINE

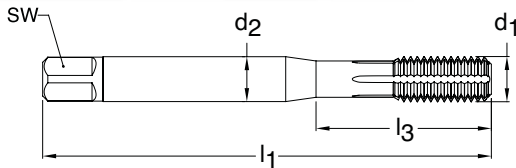

Through holes



Blind holes



TiAlN coated



Radial coolant

Series 1721
Standard DIN 371
Tool Material HSS-E PM
Flute Oil grooves
Chamfer Form C • 2-3
Class of Fit 6HX



d1 - P	D Limits	Tap Drill Range mm	Number of Flutes	d2 mm	SW mm	l1 mm	l3 mm	Order Code	EDP Number	Stock
M8 X 1.00	D7/D8	7.520 - 7.620	5	8.00	6.20	90.00	35.00	8.005	9017210080050	○
M10 X 1.00	D7/D8	9.520 - 9.620	5	10.00	8.00	90.00	35.00	10.005	9017210100050	○
M10 X 1.25	D7/D8	9.360 - 9.470	5	10.00	8.00	100.00	39.00	10.006	9017210100060	●

METRIC FINE

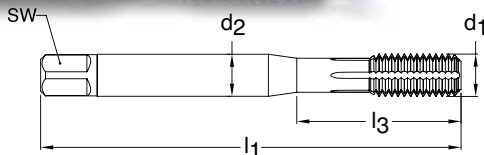

Through holes



Blind holes



TiCN coated



Radial coolant

Series 1272
Standard DIN 371
Tool Material HSS-E PM
Flute Oil grooves
Chamfer Form C • 2-3
Class of Fit 6HX



d1 - P	D Limits	Tap Drill Range mm	Number of Flutes	d2 mm	SW mm	l1 mm	l3 mm	Order Code	EDP Number	Stock
M9 X 1.00	D7/D8	8.520 - 8.620	5	9.00	7.00	90.00	35.00	9.005	9012720090050	●
M10 X 1.00	D7/D8	9.520 - 9.620	5	10.00	8.00	90.00	35.00	10.005	9012720100050	●
M10 X 1.25	D7/D8	9.360 - 9.470	5	10.00	8.00	100.00	39.00	10.006	9012720100060	○

METRIC FINE

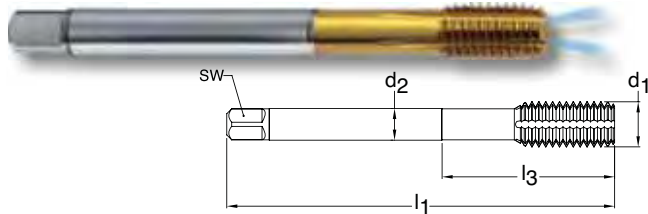

Series 338
Standard DIN 374
Tool Material HSS-E PM
Flute Oil grooves
Chamfer Form C • 2-3
Class of Fit 6HX



Through holes **Blind holes** **TiN coated** **Radial coolant**

d1 - P	D Limits	Tap Drill Range mm	Number of Flutes	d2 mm	SW mm	l1 mm	l3 mm	Order Code	EDP Number	Stock
M8 X 1.00	D7/D8	7.520 - 7.620	5	6.00	4.90	90.00	N/A	8.005	9003380080050	○
M10 X 1.00	D7/D8	9.520 - 9.620	5	7.00	5.50	90.00	N/A	10.005	9003380100050	○
M12 X 1.50	D8/D9	11.260 - 11.380	6	9.00	7.00	100.00	N/A	12.007	9003380120070	○
M14 X 1.50	D10/D11	13.260 - 13.380	6	11.00	9.00	100.00	N/A	14.007	9003380140070	●
M16 X 1.50	D10/D11	15.260 - 15.380	6	12.00	9.00	100.00	N/A	16.007	9003380160070	○

METRIC FINE

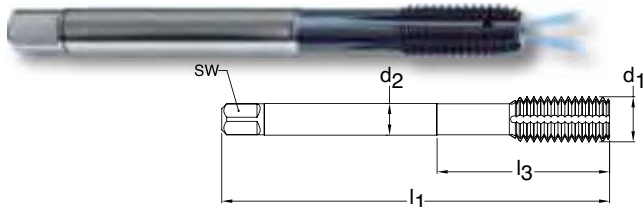

Series 1723
Standard DIN 374
Tool Material HSS-E PM
Flute Oil grooves
Chamfer Form C • 2-3
Class of Fit 6HX

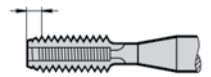

Through holes **Blind holes** **TiAlN coated** **Radial coolant**

d1 - P	D Limits	Tap Drill Range mm	Number of Flutes	d2 mm	SW mm	l1 mm	l3 mm	Order Code	EDP Number	Stock
M12 X 1.00	D7/D8	11.520 - 11.620	6	9.00	7.00	100.00	N/A	12.005	9017230120050	○
M12 X 1.25	D7/D8	11.360 - 11.470	6	9.00	7.00	100.00	N/A	12.006	9017230120060	●
M12 X 1.50	D8/D9	11.260 - 11.380	6	9.00	7.00	100.00	N/A	12.007	9017230120070	○
M14 X 1.50	D10/D11	13.260 - 13.380	6	11.00	9.00	100.00	N/A	14.007	9017230140070	●
M16 X 1.50	D10/D11	15.260 - 15.380	6	12.00	9.00	100.00	N/A	16.007	9017230160070	●
M18 X 1.50	D10/D11	17.260 - 17.380	6	14.00	11.00	110.00	N/A	18.007	9017230180070	●
M20 X 1.50	D11/D12	19.260 - 19.380	7	16.00	12.00	125.00	N/A	20.007	9017230200070	○
M24 X 1.50	D11/D12	23.260 - 23.380	8	18.00	14.50	140.00	N/A	24.007	9017230240070	○

METRIC FINE

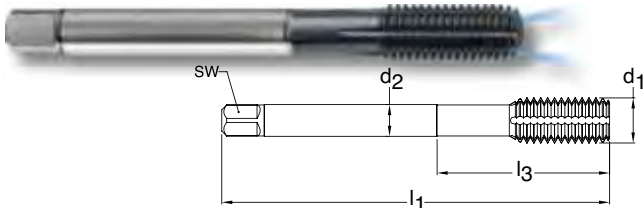

Series 1273
Standard DIN 374
Tool Material HSS-E PM
Flute Oil grooves
Chamfer Form C • 2-3
Class of Fit 6HX



Through holes **Blind holes** **TiCN coated** **Radial coolant**

d1 - P	D Limits	Tap Drill Range mm	Number of Flutes	d2 mm	SW mm	l1 mm	l3 mm	Order Code	EDP Number	Stock
M12 X 1.00	D7/D8	11.520 - 11.620	6	9.00	7.00	100.00	N/A	12.005	9012730120050	○
M12 X 1.25	D7/D8	11.360 - 11.470	6	9.00	7.00	100.00	N/A	12.006	9012730120060	●
M12 X 1.50	D8/D9	11.260 - 11.380	6	9.00	7.00	100.00	N/A	12.007	9012730120070	●
M14 X 1.00	D9/D10	13.520 - 13.620	6	11.00	9.00	100.00	N/A	14.005	9012730140050	○
M14 X 1.25	D9/D10	13.360 - 13.470	6	11.00	9.00	100.00	N/A	14.006	9012730140060	●
M14 X 1.50	D10/D11	13.260 - 13.380	6	11.00	9.00	100.00	N/A	14.007	9012730140070	●
M16 X 1.50	D10/D11	15.260 - 15.380	6	12.00	9.00	100.00	N/A	16.007	9012730160070	○
M18 X 1.50	D10/D11	17.260 - 17.380	6	14.00	11.00	110.00	N/A	18.007	9012730180070	○
M20 X 1.50	D11/D12	19.260 - 19.380	7	16.00	12.00	125.00	N/A	20.007	9012730200070	○
M22 X 1.50	D11/D12	21.260 - 21.440	7	18.00	14.50	125.00	N/A	22.007	9012730220070	○
M24 X 1.50	D11/D12	23.260 - 23.380	8	18.00	14.50	140.00	N/A	24.007	9012730240070	○

"Tap drill Range" given is per the Class of Fit shown per Series #
 Additional Tap Drill sizes & percent of thread engagement can be found on pages 238-239.

METRIC

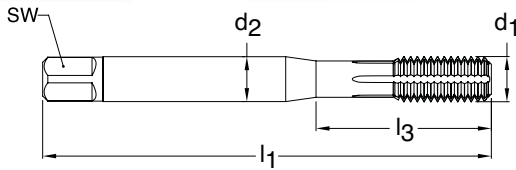

Through holes



Blind holes



TiN coated



Axial coolant

Chamfer Form E • 1.5-2

Class of Fit

6HX



d1 - P	D Limits	Tap Drill Range mm	Number of Flutes	d2 mm	SW mm	l1 mm	l3 mm	Order Code	EDP Number	Stock
*M3 X 0.50	D5/D6	2.78 - 2.84	4	3.50	2.70	56.00	18.00	3.000	9017250030000	○
*M4 X 0.70	D6/D7	3.62 - 3.76	4	4.50	3.40	63.00	21.00	4.000	9017250040000	○
M5 X 0.80	D7/D8	4.62 - 4.68	4	6.00	4.90	70.00	25.00	5.000	9017250050000	○
M6 X 1.00	D8/D9	5.52 - 5.60	4	6.00	4.90	80.00	30.00	6.000	9017250060000	●
M8 X 1.25	D9/D10	7.39 - 7.47	5	8.00	6.20	90.00	35.00	8.000	9017250080000	●
M10 X 1.50	D10/D11	9.29 - 9.37	5	10.00	8.00	100.00	39.00	10.000	9017250100000	●

* M3, M4 no axial coolant

METRIC

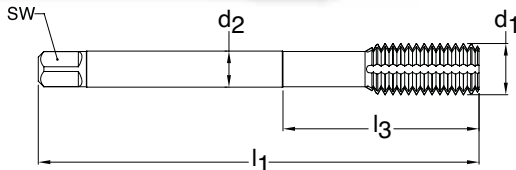

Through holes



Blind holes



TiN coated



Axial coolant

Chamfer Form E • 1.5-2

Class of Fit

6HX



d1 - P	D Limits	Tap Drill Range mm	Number of Flutes	d2 mm	SW mm	l1 mm	l3 mm	Order Code	EDP Number	Stock
M12 X 1.75	D11/D12	11.18 - 11.28	5	9.00	7.00	110.00	N/A	12.000	9017270120000	○
M20 X 2.50	D14/D15	18.85 - 19.00	7	16.00	12.00	140.00	N/A	20.000	9017270200000	○

METRIC FINE

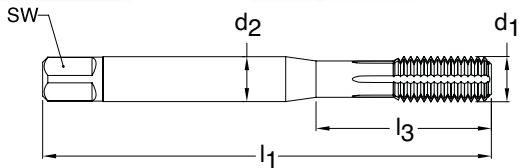

Series 1729
Standard DIN 371
Tool Material HSS-E PM
Flute Oil grooves

Chamfer Form E • 1.5-2

Class of Fit 6HX



Blind holes



TiN coated



Axial coolant

d1 - P	D Limits	Tap Drill Range mm	Number of Flutes	d2 mm	SW mm	l1 mm	l3 mm	Order Code	EDP Number	Stock
M8 X 1.00	D7/D8	7.52 - 7.62	5	8.00	6.20	90.00	35.00	8.005	9017290080050	○
M10 X 1.00	D7/D8	9.52 - 9.62	5	10.00	8.00	90.00	35.00	10.005	9017290100050	○
M10 X 1.25	D7/D8	9.36 - 9.47	5	10.00	8.00	100.00	39.00	10.006	9017290100060	○

METRIC FINE

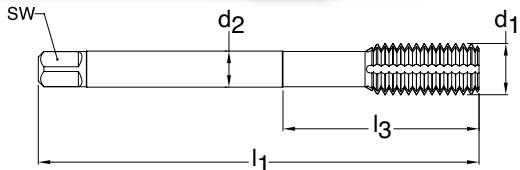

Series 1731
Standard DIN 374
Tool Material HSS-E PM
Flute Oil grooves

Chamfer Form E • 1.5-2

Class of Fit 6HX



Blind holes



TiN coated



Axial coolant

d1 - P	D Limits	Tap Drill Range mm	Number of Flutes	d2 mm	SW mm	l1 mm	l3 mm	Order Code	EDP Number	Stock
M12 X 1.00	D7/D8	11.52 - 11.62	6	9.00	7.00	100.00	N/A	12.005	9017310120050	○
M12 X 1.25	D7/D8	11.36 - 11.47	6	9.00	7.00	100.00	N/A	12.006	9017310120060	○
M12 X 1.50	D8/D9	11.26 - 11.38	6	9.00	7.00	100.00	N/A	12.007	9017310120070	○
M14 X 1.50	D10/D11	13.26 - 13.38	6	11.00	9.00	100.00	N/A	14.007	9017310140070	○
M18 X 1.50	D10/D11	17.26 - 17.38	6	14.00	11.00	110.00	N/A	18.007	9017310180070	○
M24 X 1.50	D11/D12	23.26 - 23.38	8	18.00	14.50	140.00	N/A	24.007	9017310240070	○

"Tap drill Range" given is per the Class of Fit shown per Series #
 Additional Tap Drill sizes & percent of thread engagement can be found on pages 238-239.

METRIC

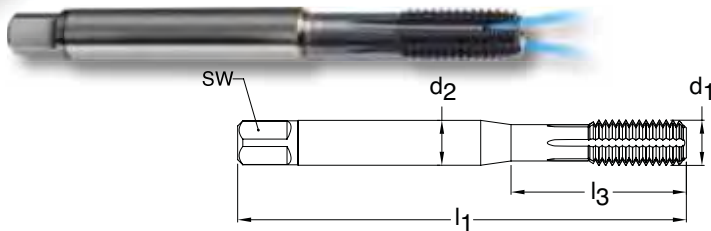

Series 1927
Standard DIN 371
Tool Material Carbide
Flute Oil grooves
Chamfer Form E • 1.5-2
Class of Fit 6HX



■ Through holes
 ■ Blind holes
 A TiAlN coated
 💧 Radial coolant

d1 - P	D Limits	Tap Drill Range mm	Number of Flutes	d2 mm	SW mm	l1 mm	l3 mm	Order Code	EDP Number	Stock
*M3 X 0.50	D5/D6	2.780 - 2.840	4	3.50	2.70	56.00	18.00	3.000	9019270030000	●
*M4 X 0.70	D6/D7	3.670 - 3.760	4	4.50	3.40	63.00	21.00	4.000	9019270040000	●
M5 X 0.80	D7/D8	4.620 - 4.680	4	6.00	4.90	70.00	25.00	5.000	9019270050000	○
M6 X 1.00	D8/D9	5.520 - 5.600	4	6.00	4.90	80.00	30.00	6.000	9019270060000	●
M8 X 1.25	D9/D10	7.390 - 7.470	5	8.00	6.20	90.00	35.00	8.000	9019270080000	●
M10 X 1.50	D10/D11	9.290 - 9.370	5	10.00	8.00	100.00	39.00	10.000	9019270100000	●

* M3, M4 no radial coolant

METRIC

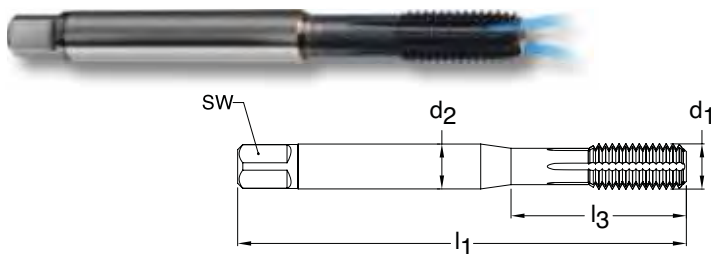

Series 1972
Standard DIN 371
Tool Material Carbide
Flute Oil grooves
Chamfer Form C • 2-3
Class of Fit 6HX



■ Through holes
 ■ Blind holes
 A TiAlN coated
 💧 Radial coolant

d1 - P	D Limits	Tap Drill Range mm	Number of Flutes	d2 mm	SW mm	l1 mm	l3 mm	Order Code	EDP Number	Stock
*M3 X 0.50	D5/D6	2.780 - 2.840	4	3.50	2.70	56.00	18.00	3.000	9019720030000	○
*M4 X 0.70	D6/D7	3.670 - 3.760	4	4.50	3.40	63.00	21.00	4.000	9019720040000	○
M5 X 0.80	D7/D8	4.620 - 4.680	4	6.00	4.90	70.00	25.00	5.000	9019720050000	●
M6 X 1.00	D8/D9	5.520 - 5.600	4	6.00	4.90	80.00	30.00	6.000	9019720060000	●
M8 X 1.25	D9/D10	7.390 - 7.470	5	8.00	6.20	90.00	35.00	8.000	9019720080000	●
M10 X 1.50	D10/D11	9.290 - 9.370	5	10.00	8.00	100.00	39.00	10.000	9019720100000	●

* M3, M4 no radial coolant

METRIC

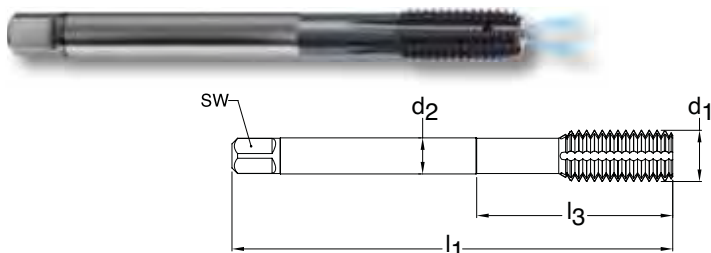

Series 1931
Standard DIN 376
Tool Material Carbide
Flute Oil grooves
Chamfer Form C • 2-3
Class of Fit 6HX

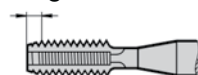

■ Through holes
 ■ Blind holes
 A TiAlN coated
 💧 Radial coolant

d1 - P	D Limits	Tap Drill Range mm	Number of Flutes	d2 mm	SW mm	l1 mm	l3 mm	Order Code	EDP Number	Stock
M12 X 1.75	D11/D12	11.180 - 11.280	6	9.00	7.00	110.00	N/A	12.000	9019310120000	●
M14 X 2.00	D13/D14	13.070 - 13.160	6	11.00	9.00	110.00	N/A	14.000	9019310140000	○
M16 X 2.00	D13/D14	15.070 - 15.160	6	12.00	9.00	110.00	N/A	16.000	9019310160000	○
M20 X 2.50	D14/D15	18.850 - 19.000	7	16.00	12.00	140.00	N/A	20.000	9019310200000	○

METRIC FINE

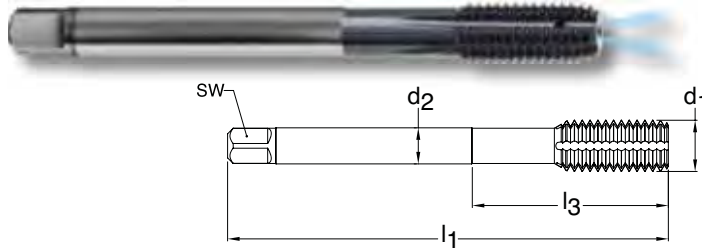

Series 1581
Standard DIN 371 / 374
Tool Material Carbide
Flute Oil grooves
Chamfer Form C • 2-3
Class of Fit 6HX



 Through holes

 Blind holes

 TiAlN coated

 Radial coolant

d1 - P	D Limits	Tap Drill Range mm	Number of Flutes	d2 mm	SW mm	l1 mm	l3 mm	Order Code	EDP Number	Stock
M10 X 1.00	D7/D8	9.520 - 9.620	5	10.00	8.00	90.00	35.00	10.005	9015810100050	○
M12 X 1.00	D7/D8	11.520 - 11.620	6	9.00	7.00	100.00	N/A	12.005	9015810120050	○
M12 X 1.50	D8/D9	11.260 - 11.380	6	9.00	7.00	100.00	N/A	12.007	9015810120070	●
M14 X 1.25	D9/D10	13.360 - 13.470	6	11.00	9.00	100.00	N/A	14.006	9015810140060	●
M14 X 1.50	D10/D11	13.260 - 13.380	6	11.00	9.00	100.00	N/A	14.007	9015810140070	○
M16 X 1.50	D10/D11	15.260 - 15.380	6	12.00	9.00	100.00	N/A	16.007	9015810160070	○
M18 X 1.50	D10/D11	17.260 - 17.380	6	14.00	11.00	110.00	N/A	18.007	9015810180070	○
M20 X 1.50	D11/D12	19.260 - 19.380	7	16.00	12.00	125.00	N/A	20.007	9015810200070	○
M24 X 1.50	D11/D12	23.260 - 23.380	8	18.00	14.50	140.00	N/A	24.007	9015810240070	○

GUHROSYNC

THE EASY WAY
TO THE PERFECT THREAD

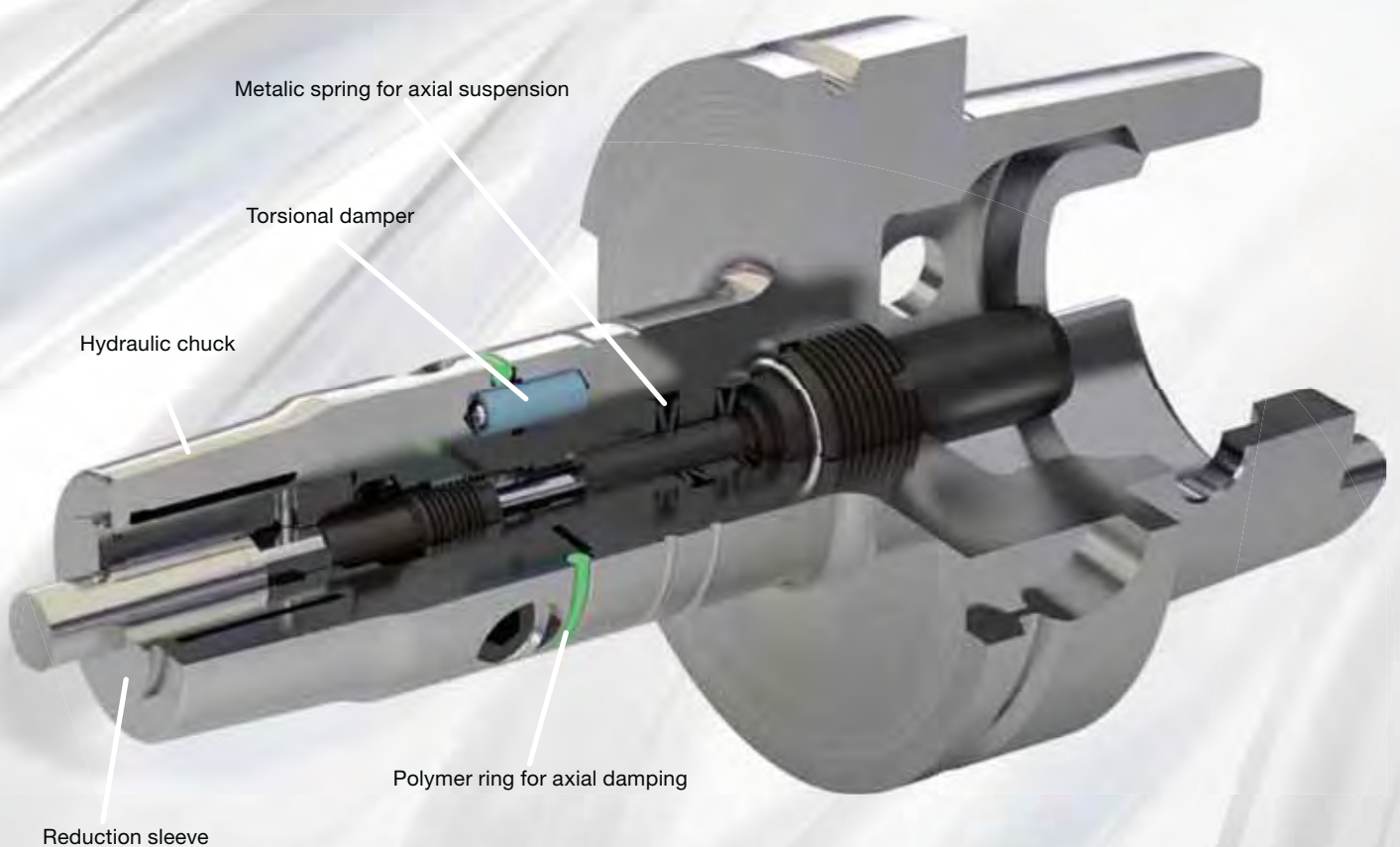

Intelligent design:

As well as the suspension and damping elements in the slender GUHROSync chucks (for the reduction of axial and radial forces during the tapping process) there is also room for the delivery set for MQL or conventional cooling lubrication and the length setting screw.

The optimal combination of long-life metal spring and polymer damping elements considerably reduces axial and radial forces

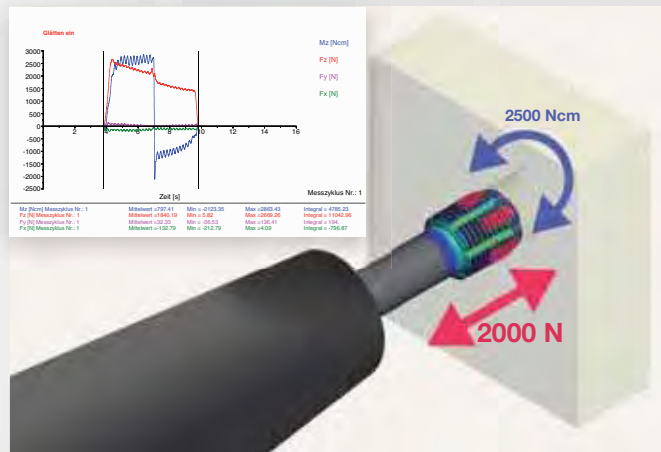

Rigid chuck

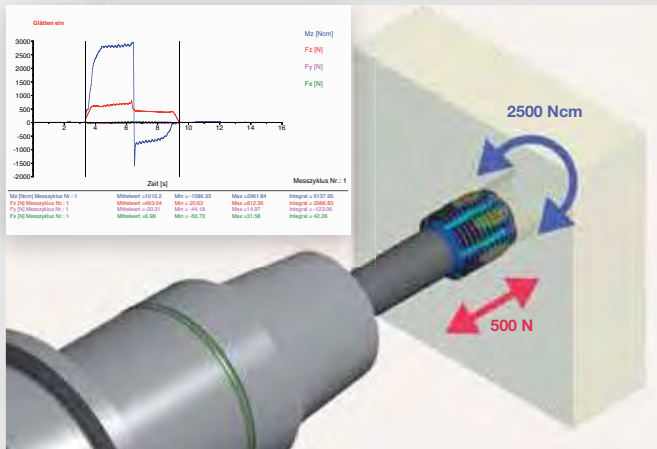

GUHROSyc

➔ IMPROVED TOOL LIFE

➔ IMPROVED THREAD QUALITY

➔ GREATER PROCESS RELIABILITY

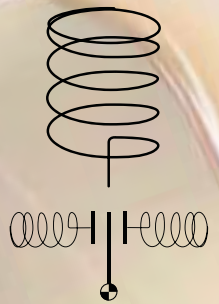

GUHRING

Made visible:
The spring symbol on the GUHROSyc displays the effect of axial and radial force.

Configuration of GUHROSynch synchro tapping chucks with straight shank for internal cooling

Hydraulic synchro tapping chucks with increased clamping force

Side lock holders

4343 HSK-A

4322 ISO taper

4233 BT taper

4087 CAT taper

Shrink fit chucks

4736 HSK-A

4758 HSK-C

4764 CAT taper

4221 MAS-BT

4299 HSK-A

4267 HSK-C

4213 ISO taper

4216 CAT taper

Hydraulic synchro tapping chucks

4601 HSK-A

Hydraulic synchro tapping chucks

4576 ISO taper

Hydraulic synchro tapping chucks

4577 MAS-BT



4525 Type B
Hydraulic synchro tapping chucks with cylindrical shank Ø 25, DIN 1835-B+E, internal cooling



4525 Type A
Hydraulic synchro tapping chucks with cylindrical shank Ø 20, DIN 1835-A, internal cooling



4364

Setting screws for synchro tapping chucks, with conventional int. cooling



4605

Sealed reduction sleeve

4606

GUHROJET reduction sleeve



Threading tool:
shank diameter x square

HSK-A hydraulic synchro tapping chucks with internal cooling

Product information

- compensates synchronisation errors
- guarantees high thread quality and optimal tool life
- minimal length compensation in tension and compression direction balances very small pitch differences between synchro spindle and tap
- reduces an increase in axial forces during the cutting cycle to a minimum
- convenient hydraulic clamping using reduction sleeves with active drive
- length-setting screw allows 3 mm readjustment
- suitable for internal cooling identifiable by black colored ring
- coolant pressure up to max. 80 bar

Scope of delivery

- incl. hexagon clamping key
Guhring no. 4912
- incl. adjustment key for adjustment screws
- order setting screw "face"
Guhring no. 4364 separately
- order reduction sleeves
Guhring no. 4605 or 4606 separately
- for conventional cooling order coolant delivery set Guhring no. 4949 separately

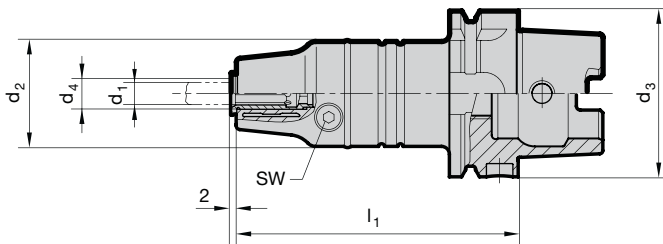

GÜHROSync

Series Number **4601**

HSK-A d ₃	d ₄ mm	for shank Ø d ₁ x VKT	for thread	d ₂ mm	l ₁ mm	tension/ compr. ± mm	SW	kg	Order Code	EDP Numbers
63	12	2.8 to 10	M3 to M12	40	106.5	0.3	4	1.5	12.063	9046010120630
63	20	6 to 16	M8 to M20	40	120.5	0.3	5	1.6	20.063	9046010200630
100	12	2.8 to 10	M3 to M12	40	113	0.3	4	2.8	12.100	9046010121000
100	20	6 to 16	M8 to M20	40	127	0.3	5	2.9	20.100	9046010201000

ISO taper hydraulic synchro tapping chucks with internal cooling

Product information

- SK30 to DIN 69871 form AD without coolant supply over collar
- SK40 to DIN 69871 form AD/B
- form B supplied with threaded pins in bores
- compensates synchronisation errors
- guarantees high thread quality and optimal tool life
- minimal length compensation in tension and compression direction balances very small pitch differences between synchro spindle and tap
- reduces an increase in axial forces during the cutting cycle to a minimum
- convenient hydraulic clamping using reduction sleeves with active drive
- length-setting screw allows 3 mm readjustment
- suitable for internal cooling identifiable by black colored ring
- coolant pressure up to max. 80 bar

Scope of delivery

- incl. hexagon clamping key
Guhring no. 4912
- incl. adjustment key for adjustment screws
- order setting screw "face"
Guhring no. 4364 separately
- order reduction sleeves
Guhring no. 4605 or 4606 separately
- order pull studs, Guhring no. 4925 or 4926 separately

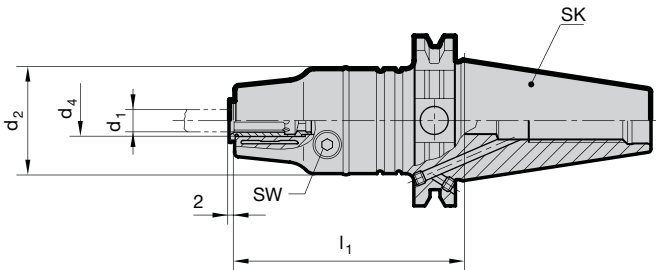

GÜHROSync

Series Number **4576**

SK	d ₄ mm	for shank Ø d ₁	for thread	d ₂ mm	l ₁ mm	tension/ compr. ± mm	SW	kg	Order Code	EDP Numbers
30	12	2.8 to 10	M3 to M12	40	81	0.3	4	0.8	12.030	9045760120300
30	20	6 to 16	M8 to M20	40	95	0.3	5	0.9	20.030	9045760200300
40	12	2.8 to 10	M3 to M12	40	85	0.3	4	1.3	12.040	9045760120400
40	20	6 to 16	M8 to M20	40	99	0.3	5	1.4	20.040	9045760200400

MAS/BT hydraulic synchro tapping chucks with internal cooling

Product information

- MAS/BT30 to JIS B 6339-2 form JD without coolant supply over collar
- MAS/BT40 to JIS B 6339-2 form JD/JF (form AD/B)
- form B supplied with threaded pins in bores
- compensates synchronisation errors
- guarantees high thread quality and optimal tool life
- minimal length compensation in tension and compression direction balances very small pitch differences between synchro spindle and tap
- reduces an increase in axial forces during the cutting cycle to a minimum
- convenient hydraulic clamping using reduction sleeves with active drive
- length-setting screw allows 3 mm re-adjustment
- suitable for internal cooling identifiable by black colored ring
- coolant pressure up to max. 80 bar

Scope of delivery

- incl. hexagon clamping key Guhring no. 4912
- incl. adjustment key for adjustment screws
- order setting screw "face" Guhring no. 4364 separately
- order reduction sleeves Guhring no. 4605 or 4606 separately
- order pull studs, Guhring no. 4927 or 4928 separately

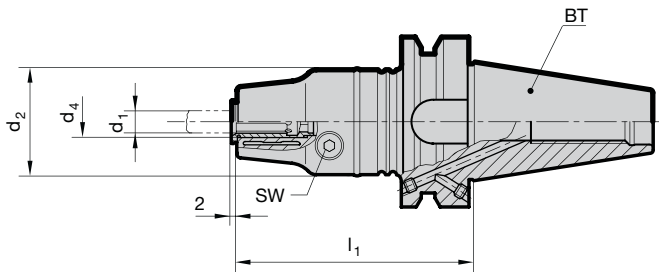

GÜHROSync

Series Number **4577**

BT	d ₄ mm	for shank Ø d ₁	for thread	d ₂ mm	l ₁ mm	tension/ compr. ± mm	SW	kg	Order Code	EDP Numbers
30	12	2.8 to 10	M3 to M12	40	81	0.3	4	0.8	12.030	9045770120300
30	20	6 to 16	M8 to M20	40	95	0.3	5	0.9	20.030	9045770200300
40	12	2.8 to 10	M3 to M12	40	85	0.3	4	1.3	12.040	9045770120400
40	20	6 to 16	M8 to M20	40	99	0.3	5	1.4	20.040	9045770200400

Straight shank hydraulic synchro tapping chucks for internal cooling

Product information

- compensates synchronisation errors
- guarantees best thread quality and optimal life
- minimal length compensation in tension and compression direction balances very small pitch differences between synchro spindle and tap
- reduces an increase in axial forces during the cutting cycle to a minimum
- convenient hydraulic clamping using reduction sleeves with active drive
- length-setting screw allows 3 mm readjustment
- holder shank to DIN 1835-A or holding in precision chucks (hydraulic, shrink fit or power clamping chucks)
- suitable for internal cooling identifiable by black colored ring
- coolant pressure up to max. 80 bar

Scope of delivery

- incl. hexagon clamping key
Guhring no. 4912
- incl. adjustment key for adjustment screws
- order setting screw "face"
Guhring no. 4364 separately
- order reduction sleeves
Guhring no. 4605 or 4606 separately

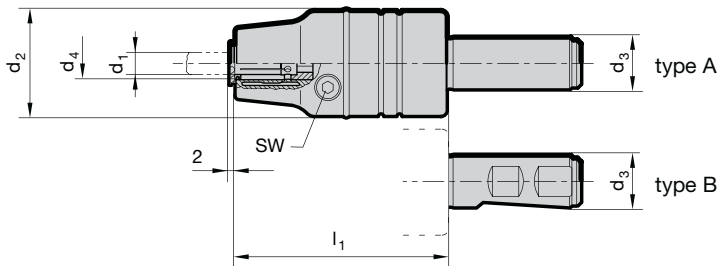

GÜHROSync

Series Number **4525**

d_3 h6 mm	d_4 mm	Type	for shank \varnothing d_1	for thread	d_2 mm	l_1 mm	tension/ compr. \pm mm	SW	kg	Order Code	EDP Numbers
20	12	A	2.8 to 10	M3 to M12	40	80	0.3	4	0.7	12.020	9045250120200
20	20	A	6 to 16	M8 to M20	40	94	0.3	5	0.8	20.020	9045250200200
25	12	B	2.8 to 10	M3 to M12	40	80	0.3	4	0.7	12.025	9045250120250
25	20	B	6 to 16	M8 to M20	40	94	0.3	5	0.8	20.025	9045250200250

Configuration of GUHROSync tapping chucks for internal cooling with MQL

MQL shrink fit chucks
HSK-A
auto. tool change



man. tool change



MQL hydraulic tapping chucks
HSK-A
auto. tool change



man. tool change



4508 MQL 1
MQL coolant delivery set
for single channel
HSK-A



4511 MQL 2
MQL coolant delivery set
for 2 channel systems
HSK-A



4513 MQL 1
MQL 2
MQL coolant delivery set
HSK-A (filler)



MQL HSK-A hydraulic
synchro tapping chucks for
single channel
auto. tool change



MQL HSK-A hydraulic
synchro tapping chucks for
2 channel systems
auto. tool change



MQL HSK-A hydraulic
synchro tapping chucks
man. tool change



4524 MQL 1 MQL 2
MQL hydraulic synchro tapping chuck with internal coolant
cylindrical shank Ø20.0 mm



4305
MQL setting screws with internal cone
for MQL synchro tapping chucks



4605
Reduction sleeves, sealed



4606
GUHROJET reduction sleeves

Threading tool with MQL shank:
shank diameter x square

MQL HSK-A hydraulic synchro tapping chucks for single channel systems and automatic tool change

Product information

- for MQL single channel systems
- MQL coolant pressure up to max. 16 bar
- compensates synchronisation errors
- guarantees high thread quality and optimal tool life
- minimal length compensation in tension and compression direction balances very small pitch differences between synchro spindle and tap
- reduces an increase in axial forces during the cutting cycle to a minimum
- convenient hydraulic clamping using reduction sleeves with active drive
- length-setting screw allows 3 mm readjustment
- Guhring MQL identifiable by green colored ring

Scope of delivery

- incl. hexagon clamping key
Guhring no. 4912
- incl. MQL coolant delivery set for automatic tool change
Guhring no. 4508
- incl. adjustment key for MQL adjustment screws
- order MQL adjustment screw
Guhring no. 4305 separately
- order reduction sleeves Guhring no. 4605 or 4606 separately

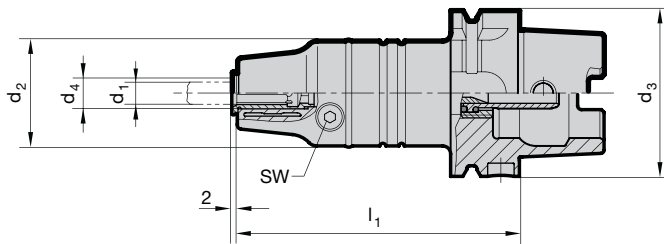

Series Number **4602**

HSK-A d ₃	d ₄ mm	for shank-Ø d ₁	for thread	d ₂ mm	l ₁ mm	tension/ compr. ± mm	SW	kg	Order Code	EDP Numbers
63	12	2.8 to 10	M3 to M12	40	106.5	0.3	4	1.5	12.063	9046020120630
63	20	6 to 16	M8 to M20	40	120.5	0.3	5	1.6	20.063	9046020200630
100	12	2.8 to 10	M3 to M12	40	113	0.3	4	2.8	12.100	9046020121000
100	20	6 to 16	M8 to M20	40	127	0.3	5	2.9	20.100	9046020201000

MQL HSK-A hydraulic synchro tapping chucks for 2 channel systems and automatic tool change

Product information

- for MQL 2 channel systems
- MQL coolant pressure up to max. 16 bar
- compensates synchronisation errors
- guarantees high thread quality and optimal tool life
- minimal length compensation in tension and compression direction balances very small pitch differences between synchro spindle and tap
- reduces an increase in axial forces during the cutting cycle to a minimum
- convenient hydraulic clamping using reduction sleeves with active drive
- length-setting screw allows 3 mm readjustment
- Guhring MQL identifiable by green colored ring

Scope of delivery

- incl. hexagon clamping key
Guhring no. 4912
- incl. MQL coolant delivery set for automatic tool change Guhring no. 4511
- incl. adjustment key for MQL adjustment screws
- order MQL adjustment screw
Guhring no. 4305 separately
- order reduction sleeves Guhring no. 4605 or 4606 separately

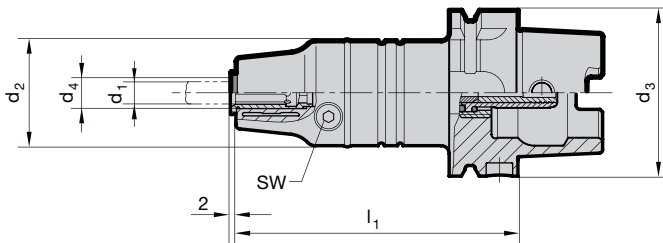

Series Number **4603**

HSK-A d ₃	d ₄ mm	for shank-Ø d ₁	for thread	d ₂ mm	l ₁ mm	tension/ compr. ± mm	SW	kg	Order Code	EDP Numbers
63	12	2.8 to 10	M3 to M12	40	106.5	0.3	4	1.5	12.063	9046030120630
63	20	6 to 16	M8 to M20	40	120.5	0.3	5	1.6	20.063	9046030200630
100	12	2.8 to 10	M3 to M12	40	113	0.3	4	2.8	12.100	9046030121000
100	20	6 to 16	M8 to M20	40	127	0.3	5	2.9	20.100	9046030201000

MQL HSK-A hydraulic synchro tapping chucks for manual tool change

Product information

- for MQL single and double channel systems
- MQL coolant pressure up to max. 16 bar
- compensates synchronisation errors
- guarantees high thread quality and optimal tool life
- minimal length compensation in tension and compression direction balances very small pitch differences between synchro spindle and tap
- reduces an increase in axial forces during the cutting cycle to a minimum
- convenient hydraulic clamping using reduction sleeves with active drive
- length-setting screw allows 3 mm readjustment
- Guhring MQL identifiable by green colored ring

Scope of delivery

- incl. hexagon clamping key Guhring no. 4912
- incl. MQL coolant delivery set for manual tool change (filler) Guhring no. 4513
- incl. adjustment key for MQL adjustment screws
- order MQL adjustment screw Guhring no. 4305 separately
- order reduction sleeves Guhring no. 4605 or 4606 separately

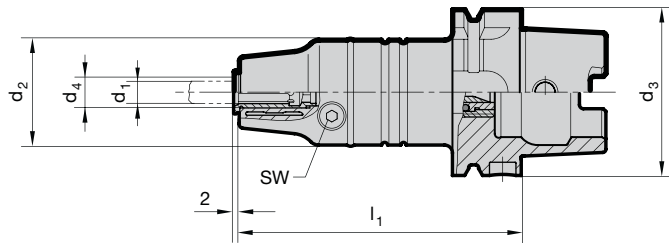

Series Number **4604**

HSK-A d ₃	d ₄ mm	for shank-Ø d ₁	for thread	d ₂ mm	l ₁ mm	tension/ compr. ± mm	SW	kg	Order Code	EDP Numbers
63	12	2.8 to 10	M3 to M12	40	106.5	0.3	4	1.5	12.063	9046040120630
63	20	6 to 16	M8 to M20	40	120.5	0.3	5	1.6	20.063	9046040200630
100	12	2.8 to 10	M3 to M12	40	113	0.3	4	2.8	12.100	9046040121000
100	20	6 to 16	M8 to M20	40	127	0.3	5	2.9	20.100	9046040201000

MQL hydraulic synchro tapping chucks with internal cooling

Product information

- for MQL single and double channel systems
- MQL coolant pressure up to max. 16 bar
- compensates synchronisation errors
- guarantees high thread quality and optimal tool life
- minimal length compensation in tension and compression direction balances very small pitch differences between synchro spindle and tap
- reduces an increase in axial forces during the cutting cycle to a minimum
- convenient hydraulic clamping using reduction sleeves with active drive
- length-setting screw allows 3 mm readjustment
- holder shank to DIN 1835-A or holding in precision chucks (hydraulic, shrink fit or power clamping chucks)
- Guhring MQL identifiable by green colored ring

Scope of delivery

- incl. hexagon clamping key
Guhring no. 4912
- incl. adjustment key for MQL adjustment screws
- order MQL adjustment screw
Guhring no. 4305 separately
- order reduction sleeves
Guhring no. 4605 or 4606 separately

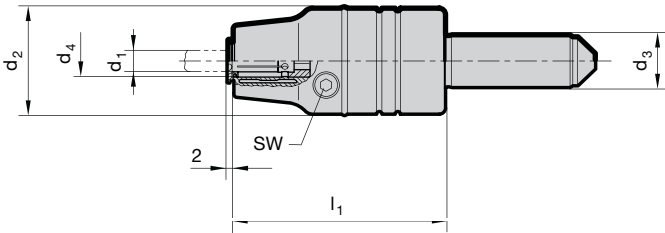

Series Number

4524

d ₃ h6 mm	d ₄ mm	for shank-Ø d ₁	for thread	d ₂ mm	l ₁ mm	tension/ compr. ± mm	SW	kg	Order Code	EDP Numbers
20	12	2.8 to 10	M3 to M12	40	80	0.3	4	0.7	12.020	9045240120200
20	20	6 to 16	M8 to M20	40	94	0.3	5	0.8	20.020	9045240200200

Reduction sleeves sealed for hydraulic synchro tapping chucks

Product information

- for clamping taps with square shank in GÜHROSync synchro tapping chucks
- clamping-Ø for tool shank tolerance h6-h9
- face side closed, therefore coolant leak-proof for threading tools with IC
- positive drive
- position setting screw on tap shank
- length-setting screw allows 3 mm readjustment

Scope of delivery

- order setting screw
Guhring no. 4364 separately
- order MQL setting screws
Guhring no. 4305 separately

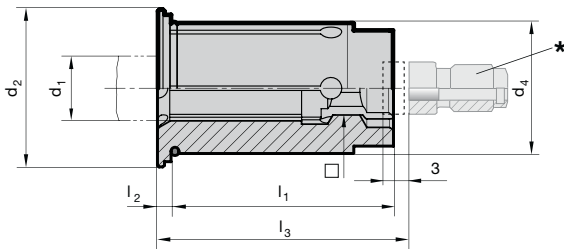

EXCLUSIVELY for
GÜHROSync

Series Number **4605**

d ₄ mm	d ₁ mm	□ mm	Standard	d ₁ inch	□ inch	d ₂ mm	l ₁ mm	l ₂ mm	l ₃ mm	* code for adjustment screw	for thread	Order Code	EDP Numbers
12.00	2.800	2.100	DIN	-	-	16.50	29.00	2.00	-	-	M2 / M4	2.812	9046050028120
12.00	3.500	2.700	DIN	-	-	16.50	29.00	2.00	-	-	M3 / M4.5 / M5	3.512	9046050035120
12.00	4.000	3.200	JIS	-	-	16.50	29.00	2.00	-	-	M3	4.012	9046050040120
12.00	4.500	3.400	DIN	-	-	16.50	29.00	2.00	26.00	4364 5.020	M4 / M6	4.512	9046050045120
12.00	4.928	3.861	ANSI	0.194	0.152	16.50	29.00	2.00	26.00	4364 5.020	10-24 & 10-32	4.912	9046050049120
12.00	5.000	4.000	JIS	-	-	16.50	29.00	2.00	26.00	4364 5.020	M4	5.012	9046050050120
12.00	5.500	4.500	JIS	-	-	16.50	29.00	2.00	26.00	4364 5.020	M5	5.512	9046050055120
12.00	5.588	4.191	ANSI	0.220	0.165	16.50	29.00	2.00	26.00	4364 5.020	12-24 & 12-28	15.512	9046050155120
12.00	6.000	4.500	JIS	-	-	16.50	29.00	2.00	26.00	4364 5.020	M6	16.012	9046050160120
12.00	6.000	4.900	DIN	-	-	16.50	29.00	2.00	26.00	4364 6.020	M4.5/M5/M6/M8	6.012	9046050060120
12.00	6.200	5.000	JIS	-	-	16.50	29.00	2.00	26.00	4364 6.020	M7 / M8	6.212	9046050062120
12.00	6.477	4.851	ANSI	0.255	0.191	16.50	29.00	2.00	26.00	4364 6.020	1/4-20 & 1/4-28	6.412	9046050064120
12.00	7.000	5.500	DIN / JIS	-	-	16.50	29.00	2.00	26.00	4364 7.020	M7 / M9 / M10	7.012	9046050070120
12.00	7.938	5.944	ANSI	0.3125	0.234	16.50	29.00	2.00	31.00	4364 7.020	1/16-27	7.912	9046050079120
12.00	8.000	6.200	DIN	-	-	16.50	29.00	2.00	31.00	4364 8.020	M8 / M11	8.012	9046050080120
12.00	8.000	6.500	JIS	-	-	16.50	29.00	2.00	31.00	4364 8.020	M11	18.012	9046050180120
12.00	8.077	6.045	ANSI	0.318	0.238	16.50	29.00	2.00	31.00	4364 7.020	5/16-18 & 5/16-24	28.012	9046050280120
12.00	8.204	6.147	ANSI	0.323	0.242	16.50	29.00	2.00	31.00	4364 7.020	7/16-14 & 7/16-20	8.212	9046050082120
12.00	8.500	6.500	JIS	-	-	16.50	29.00	2.00	31.00	4364 8.020	M12	8.512	9046050085120
12.00	9.000	7.000	DIN	-	-	16.50	29.00	2.00	32.00	4364 9.020	M9 / M12	9.012	9046050090120
12.00	9.322	6.985	ANSI	0.367	0.275	16.50	29.00	2.00	32.00	4364 9.020	1/2-13 & 1/2-20	9.312	9046050093120
12.00	9.677	7.264	ANSI	0.381	0.286	16.50	29.00	2.00	33.00	4364 9.020	3/8-16 & 3/8-24	9.612	9046050096120
12.00	10.000	8.000	DIN	-	-	16.50	29.00	2.00	36.00	4364 10.020	M10	10.012	9046050100120

Reduction sleeves sealed for hydraulic synchro tapping chucks

Product information

- for clamping taps with square shank in GÜHROSync synchro tapping chucks
- clamping-Ø for tool shank tolerance h6-h9
- face side closed, therefore coolant leak-proof for threading tools with IC
- positive drive
- position setting screw on tap shank
- length-setting screw allows 3 mm readjustment

Scope of delivery

- order setting screw
Guhring no. 4364 separately
- order MQL setting screws
Guhring no. 4305 separately

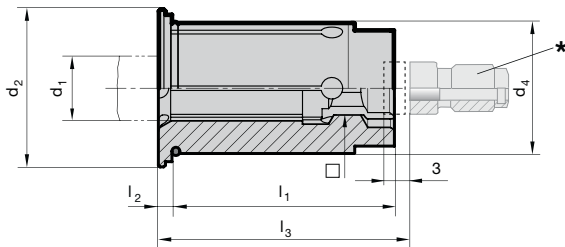

EXCLUSIVELY for
GÜHROSync

Series Number **4605**

d ₄ mm	d ₁ mm	□ mm	Standard	d ₁ inch	□ inch	d ₂ mm	l ₁ mm	l ₂ mm	l ₃ mm	* code for adjustment screw	for thread	Order Code	EDP Numbers
20.00	6.000	4.500	JIS	-	-	24.10	34.00	2.00	26.00	4364 6.032	M6	26.020	9046050260200
20.00	6.000	4.900	DIN	-	-	24.10	34.00	2.00	26.00	4364 6.032	M4.5/M5/M6/M8	6.020	9046050060200
20.00	6.200	5.000	JIS	-	-	24.10	34.00	2.00	26.00	4364 6.032	M7 / M8	6.220	9046050062200
20.00	6.477	4.851	ANSI	0.255	0.191	24.10	34.00	2.00	26.00	4364 6.032	1/4-20 & 1/4-28	6.420	9046050064200
20.00	7.000	5.500	DIN / JIS	-	-	24.10	34.00	2.00	26.00	4364 7.032	M7 / M9 / M10	7.020	9046050070200
20.00	7.938	5.944	ANSI	0.3125	0.234	24.10	34.00	2.00	31.00	4364 7.032	1/16-27	7.920	9046050079200
20.00	8.000	6.200	DIN	-	-	24.10	34.00	2.00	31.00	4364 8.032	M8 / M11	8.020	9046050080200
20.00	8.000	6.500	JIS	-	-	24.10	34.00	2.00	31.00	4364 8.032	M11	18.020	9046050180200
20.00	8.077	6.045	ANSI	0.318	0.238	24.10	34.00	2.00	31.00	4364 8.032	5/16-18 & 5/16-24	28.020	9046050280200
20.00	8.204	6.147	ANSI	0.323	0.242	24.10	34.00	2.00	31.00	4364 8.032	7/16-14 & 7/16-20	8.220	9046050082200
20.00	8.500	6.500	JIS	-	-	24.10	34.00	2.00	31.00	4364 8.032	M12	8.520	9046050085200
20.00	9.000	7.000	DIN	-	-	24.10	34.00	2.00	32.00	4364 9.032	M9 / M12	9.020	9046050090200
20.00	9.322	6.985	ANSI	0.367	0.275	24.10	34.00	2.00	32.00	4364 8.032	1/2-13 & 1/2-20	9.320	9046050093200
20.00	9.677	7.264	ANSI	0.381	0.286	24.10	34.00	2.00	33.00	4364 9.032	3/8-16 & 3/8-24	9.620	9046050096200
20.00	10.000	8.000	DIN	-	-	24.10	34.00	2.00	36.00	4364 10.032	M10	10.020	9046050100200
20.00	10.500	8.000	JIS	-	-	24.10	34.00	2.00	36.00	4364 10.032	M14	10.520	9046050105200
20.00	10.897	8.179	ANSI	0.4290	0.3220	24.10	34.00	2.00	35.00	4364 10.032	9/16-12 & 9/16-18	10.820	9046050108200
20.00	11.000	9.000	DIN	-	-	24.10	34.00	2.00	37.00	4364 11.032	M14	11.020	9046050110200
20.00	12.000	9.000	DIN	-	-	24.10	34.00	2.00	37.00	4364 11.032	M12 / M16	12.020	9046050120200
20.00	12.192	9.144	ANSI	0.480	0.36	24.10	34.00	2.00	36.00	4364 11.032	5/8-11 & 5/8-18	12.120	9046050121200
20.00	12.500	10.000	JIS	-	-	24.10	34.00	2.00	38.00	4364 11.032	M16	12.520	9046050125200
20.00	13.000	10.000	JIS	-	-	24.10	34.00	2.00	38.00	4364 11.032	M17	13.020	9046050130200
20.00	14.000	11.000	DIN / JIS	-	-	24.10	34.00	2.00	39.00	4364 11.032	M18	14.020	9046050140200
20.00	14.288	10.693	ANSI	0.5625	0.421	24.10	34.00	2.00	38.00	4364 11.032	1/4-18	14.220	9046050142200
20.00	14.986	10.719	ANSI	0.590	0.422	24.10	34.00	2.00	39.00	4364 11.032	3/4-10 & 3/4-16	14.920	9046050149200
20.00	15.000	12.000	JIS	-	-	24.10	34.00	2.00	40.00	4364 16.032	M20	15.020	9046050150200
20.00	16.000	12.000	DIN	-	-	24.10	34.00	2.00	41.00	4364 16.032	M20	16.020	9046050160200

GUHROJET reduction sleeves for hydraulic synchro tapping chucks

Product information

- for clamping taps with square shank in GUHROSync synchro tapping chucks
- clamping-Ø for tool shank tolerance h6-h9
- positive drive of reduction bush in Guhrosync synchro chuck
- with coolant slots for peripheral cooling, therefore process and tool life improvement
- coiled swarf is consistently washed away
- position setting screw on tap shank
- length-setting screw allows 3 mm readjustment

Scope of delivery

- order setting screw
Guhring no. 4364 separately
- order MQL setting screws
Guhring no. 4305 separately

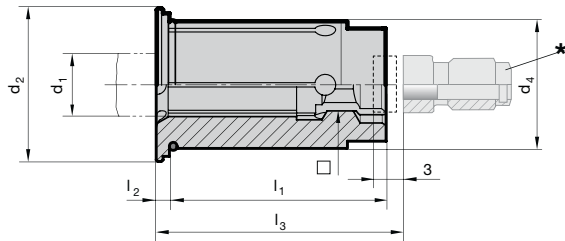

GUHROJET
EXCLUSIVELY for
GUHROSync

Series Number **4606**

d ₄ mm	d ₁ mm	□ mm	Standard	d ₁ inch	□ inch	d ₂ mm	l ₁ mm	l ₂ mm	l ₃ mm	* code for adjustment screw	for thread	Order Code	EDP Numbers
12.00	2.800	2.100	DIN	-	-	16.50	29.00	2.00	-	-	M2 / M4	2.812	9046060028120
12.00	3.500	2.700	DIN	-	-	16.50	29.00	2.00	-	-	M3 / M4.5 / M5	3.512	9046060035120
12.00	3.581	2.794	ANSI	0.1410	0.110	16.50	29.00	2.00	-	-	0-80 to 6-40	3.612	9046060036120
12.00	4.000	3.200	JIS	-	-	16.50	29.00	2.00	-	-	M3	4.012	9046060040120
12.00	4.268	3.327	ANSI	0.1680	0.131	16.50	29.00	2.00	-	-	8-32 & 8-36	4.312	9046060043120
12.00	4.500	3.400	DIN	-	-	16.50	29.00	2.00	-	-	M4 / M6	4.512	9046060045120
12.00	4.928	3.861	ANSI	0.194	0.152	16.50	29.00	2.00	-	-	10-24 & 10-32	4.912	9046060049120
12.00	5.000	4.000	JIS	-	-	16.50	29.00	2.00	-	-	M4	5.012	9046060050120
12.00	5.500	4.500	JIS	-	-	16.50	29.00	2.00	-	-	M5	5.512	9046060055120
12.00	5.588	4.191	ANSI	0.220	0.165	16.50	29.00	2.00	-	-	12-24 & 12-28	15.512	9046060155120
12.00	6.000	4.500	JIS	-	-	16.50	29.00	2.00	26.00	6.020	M6	16.012	9046060160120
12.00	6.000	4.900	DIN	-	-	16.50	29.00	2.00	26.00	6.020	M4.5/M5/M6/M8	6.012	9046060060120
12.00	6.200	5.000	JIS	-	-	16.50	29.00	2.00	26.00	6.020	M7 / M8	6.212	9046060062120
12.00	6.477	4.851	ANSI	0.255	0.191	16.50	29.00	2.00	26.00	6.020	1/4-20 & 1/4-28	6.412	9046060064120
12.00	7.000	5.500	DIN / JIS	-	-	16.50	29.00	2.00	26.00	7.020	M7 / M9 / M10	7.012	9046060070120
12.00	7.938	5.944	ANSI	0.3125	0.234	16.50	29.00	2.00	31.00	7.020	1/16-27	7.912	9046060079120
12.00	8.000	6.200	DIN	-	-	16.50	29.00	2.00	31.00	8.020	M8 / M11	8.012	9046060080120
12.00	8.000	6.500	JIS	-	-	16.50	29.00	2.00	31.00	8.020	M11	18.012	9046060180120
12.00	8.077	6.045	ANSI	0.318	0.238	16.50	29.00	2.00	31.00	7.020	5/16-18 & 5/16-24	28.012	9046060280120
12.00	8.204	6.147	ANSI	0.323	0.242	16.50	29.00	2.00	31.00	8.020	7/16-14 & 7/16-20	8.212	9046060082120
12.00	8.500	6.500	JIS	-	-	16.50	29.00	2.00	31.00	8.020	M12	8.512	9046060085120
12.00	9.000	7.000	DIN	-	-	16.50	29.00	2.00	32.00	9.020	M9 / M12	9.012	9046060090120
12.00	9.322	6.985	ANSI	0.367	0.275	16.50	29.00	2.00	32.00	9.020	1/2-13 & 1/2-20	9.312	9046060093120
12.00	9.677	7.264	ANSI	0.381	0.286	16.50	29.00	2.00	33.00	9.020	3/8-16 & 3/8-24	9.612	9046060096120
12.00	10.000	8.000	DIN	-	-	16.50	29.00	2.00	36.00	10.020	M10	10.012	9046060100120

GUHROJET reduction sleeves for hydraulic synchro tapping chucks

Product information

- for clamping taps with square shank in GUHROSync synchro tapping chucks
- clamping-Ø for tool shank tolerance h6-h9
- positive drive of reduction bush in Guhrosync synchro chuck
- with coolant slots for peripheral cooling, therefore process and tool life improvement
- coiled swarf is consistently washed away
- position setting screw on tap shank
- length-setting screw allows 3 mm readjustment

Scope of delivery

- order setting screw
Guhring no. 4364 separately
- order MQL setting screws
Guhring no. 4305 separately

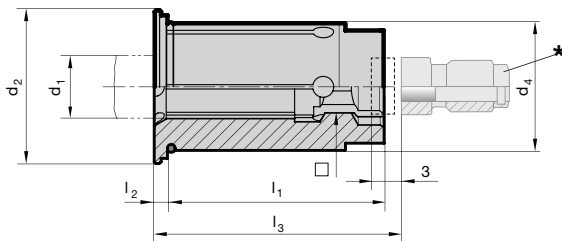

GUHROJET
EXCLUSIVELY for
GUHROSync

Series Number **4606**

d ₄ mm	d ₁ mm	□ mm	Standard	d ₁ inch	□ inch	d ₂ mm	l ₁ mm	l ₂ mm	l ₃ mm	* code for adjustment screw	for thread	Order Code	EDP Numbers
20.00	6.000	4.500	JIS	-	-	24.10	34.00	2.00	26.00	6.032	M6	26.020	9046060260200
20.00	6.000	4.900	DIN	-	-	24.10	34.00	2.00	26.00	6.032	M4.5/M5/M6/M8	6.020	9046060060200
20.00	6.200	5.000	JIS	-	-	24.10	34.00	2.00	26.00	6.032	M7 / M8	6.220	9046060062200
20.00	6.477	4.851	ANSI	0.255	0.191	24.10	34.00	2.00	26.00	6.032	1/4-20 & 1/4-28	6.420	9046060064200
20.00	7.000	5.500	DIN / JIS	-	-	24.10	34.00	2.00	26.00	7.032	M7 / M9 / M10	7.020	9046060070200
20.00	7.938	5.944	ANSI	0.3125	0.234	24.10	34.00	2.00	31.00	7.032	1/16-27	7.920	9046060079200
20.00	8.000	6.200	DIN	-	-	24.10	34.00	2.00	31.00	8.032	M8 / M11	8.020	9046060080200
20.00	8.000	6.500	JIS	-	-	24.10	34.00	2.00	31.00	8.032	M11	18.020	9046060180200
20.00	8.077	6.045	ANSI	0.318	0.238	24.10	34.00	2.00	31.00	8.032	5/16-18 & 5/16-24	28.020	9046060280200
20.00	8.204	6.147	ANSI	0.323	0.242	24.10	34.00	2.00	31.00	8.032	7/16-14 & 7/16-20	8.220	9046060082200
20.00	8.500	6.500	JIS	-	-	24.10	34.00	2.00	31.00	8.032	M12	8.520	9046060085200
20.00	9.000	7.000	DIN	-	-	24.10	34.00	2.00	32.00	9.032	M9 / M12	9.020	9046060090200
20.00	9.322	6.985	ANSI	0.367	0.275	24.10	34.00	2.00	32.00	9.032	1/2-13 & 1/2-20	9.320	9046060093200
20.00	9.677	7.264	ANSI	0.381	0.286	24.10	34.00	2.00	33.00	9.032	3/8-16 & 3/8-24	9.620	9046060096200
20.00	10.000	8.000	DIN	-	-	24.10	34.00	2.00	36.00	10.032	M10	10.020	9046060100200
20.00	10.500	8.000	JIS	-	-	24.10	34.00	2.00	36.00	10.032	M14	10.520	9046060105200
20.00	10.897	8.179	ANSI	0.4290	0.3220	24.10	34.00	2.00	35.00	10.032	9/16-12 & 9/16-18	10.820	9046060108200
20.00	11.000	9.000	DIN	-	-	24.10	34.00	2.00	37.00	11.032	M14	11.020	9046060110200
20.00	12.000	9.000	DIN	-	-	24.10	34.00	2.00	37.00	11.032	M12 / M16	12.020	9046060120200
20.00	12.192	9.144	ANSI	0.480	0.36	24.10	34.00	2.00	36.00	11.032	5/8-11 & 5/8-18	12.120	9046060121200
20.00	12.500	10.000	JIS	-	-	24.10	34.00	2.00	38.00	11.032	M16	12.520	9046060125200
20.00	13.000	10.000	JIS	-	-	24.10	34.00	2.00	38.00	11.032	M17	13.020	9046060130200
20.00	14.000	11.000	DIN / JIS	-	-	24.10	34.00	2.00	39.00	14.032	M18	14.020	9046060140200
20.00	14.288	10.693	ANSI	0.5625	0.421	24.10	34.00	2.00	38.00	11.032	1/4-18	14.220	9046060142200
20.00	14.986	10.719	ANSI	0.590	0.422	24.10	34.00	2.00	39.00	11.032	3/4-10 & 3/4-16	14.920	9046060149200
20.00	15.000	12.000	JIS	-	-	24.10	34.00	2.00	40.00	16.032	M20	15.020	9046060150200
20.00	16.000	12.000	DIN	-	-	24.10	34.00	2.00	41.00	16.032	M20	16.020	9046060160200

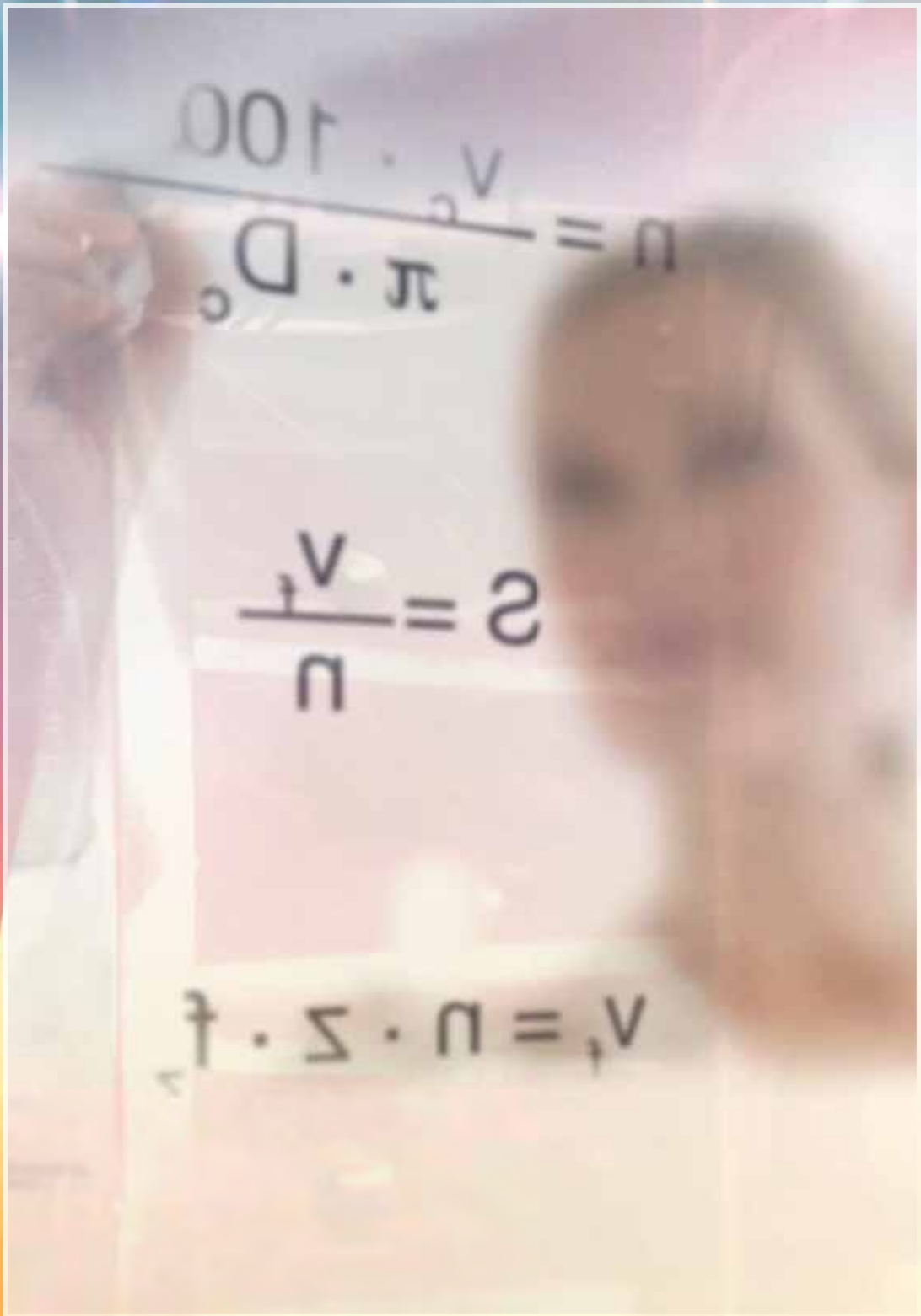

TECHNICAL INFORMATION



Technical Information

COMMON METRIC & FRACTIONAL TAP SIZES AND PITCHES

METRIC		METRIC FINE				UNC		UNF	
Tap Diameter	Pitch (mm)	Tap Diameter	Pitch (mm)	Tap Diameter	Pitch (mm)	Tap Diameter	Pitch (tpi)	Tap Diameter	Pitch (tpi)
M1.4	0.30	M3	0.35	M22	2.00	# 1	64	# 0	80
M1.6	0.35	M3.5	0.35	M24	1.50	# 2	56	# 1	72
M1.7	0.35	M4	0.50	M24	2.00	# 3	48	# 2	64
M1.8	0.35	M5	0.50	M25	1.50	# 4	40	# 3	56
M2	0.40	M6	0.50	M26	1.50	# 5	40	# 4	48
M2.2	0.45	M6	0.75	M27	1.50	# 6	32	# 5	44
M2.3	0.40	M7	0.75	M27	2.00	# 8	32	# 6	40
M2.5	0.45	M8	0.50	M28	1.50	# 10	24	# 8	36
M2.6	0.45	M8	0.75	M30	1.50	# 12	24	# 10	32
M3	0.50	M8	1.00	M30	2.00	1/4"	20	# 12	28
M3.5	0.60	M9	1.00	M32	1.50	5/16"	18	1/4"	28
M4	0.70	M10	0.75	M35	1.50	3/8"	16	5/16"	24
M5	0.80	M10	1.00	M35	1.50	7/16"	14	3/8"	24
M6	1.00	M10	1.25	M36	1.50	1/2"	13	7/16"	20
M7	1.00	M11	1.00	M38	1.50	9/16"	12	1/2"	20
M8	1.25	M12	1.00	M40	1.50	5/8"	11	9/16"	18
M10	1.50	M12	1.25	M50	1.50	3/4"	10	5/8"	18
M12	1.75	M12	1.50	M63	1.50	7/8"	9	3/4"	16
M14	2.00	M14	1.00			1"	8	7/8"	14
M16	2.00	M14	1.25			1 1/8"	7	1"	12
M18	2.50	M14	1.50			1 1/4"	7	1 1/8"	12
M20	2.50	M15	1.00			1 3/8"	6	1 1/4"	12
M22	2.50	M16	1.00			1 1/2"	6	1 3/8"	12
M24	3.00	M16	1.50					1 1/2"	12
M27	3.00	M18	1.00						
M30	3.50	M18	1.50						
M36	4.00	M18	2.00						
M39	4.00	M20	1.00						
M42	4.50	M20	1.50						
M45	4.50	M20	2.00						
M48	5.00	M22	1.00						
M52	5.00	M22	1.50						

Technical Information

Definitions and angles, centers and flute forms

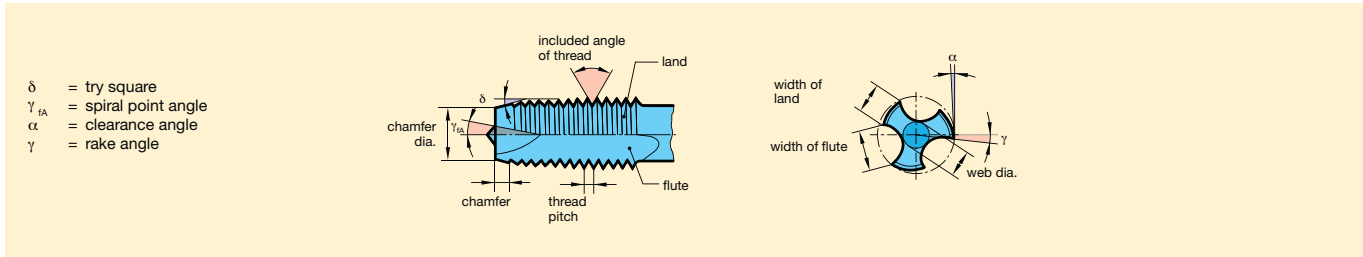
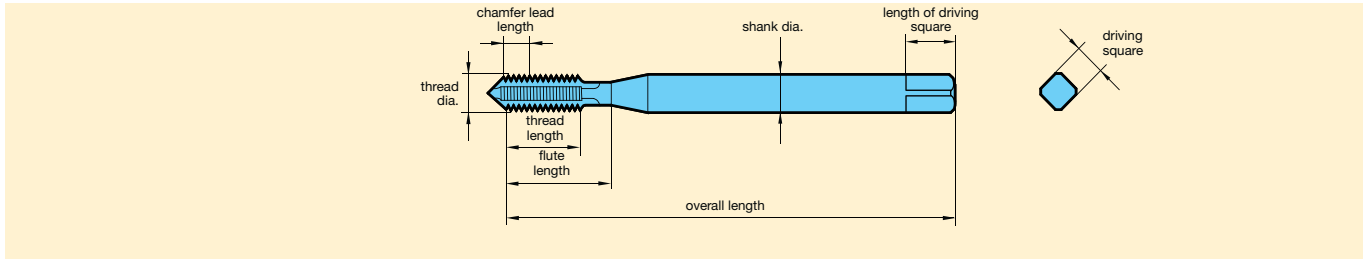

Flute forms



Types of centers (standard, to DIN 2197/DIN 2175)

Note: DIN standard taps ≤ 10.0 mm diameter are manufactured with male centers

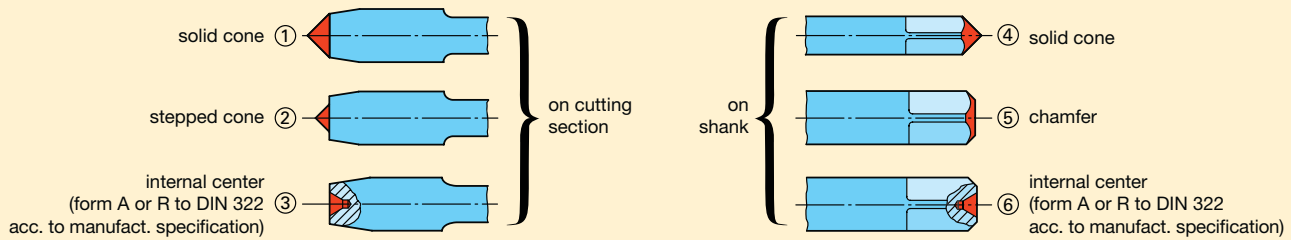

Thread dia. range mm	Center on cutting section		Center on shank
	with chamfer forms A, C, D, E	with chamfer form B	
≤ 4.2	①	①	④ ⑤ ⑥
$> 4.2 \dots 5.6$	① ②	①	④ ⑤ ⑥
$> 5.6 \dots 10.0$	① ② ③	① ② ③	④ ⑤ ⑥
> 10.0	③	③	⑥

Coolant duct geometries

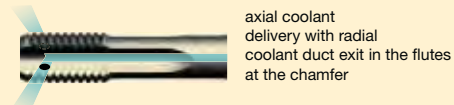

Chamfer forms, selection and application

Application recommendations

The type of tapped hole required determines the chamfer. Generally the tap geometry - i.e. form, number and direction of flutes, cutting angle, etc. - depend on the material to be machined and on the application. Basically, taps up to M16 for tapping ISO metric threads or for the engineering industry in general, have 3 flutes, and above this size 4 or more flutes.

Taps with left-hand flutes and taps with spiral points remove the chips in the cutting direction or direction of feed and are therefore especially suitable for tapping through holes. Taps with straight flutes and long chamfer lead (form D) also give good results.

As far as blind holes are concerned we recommend taps with right-hand spiral flutes or straight fluted taps with a short chamfer lead length. Tools with right-hand spiral flutes have the chip flow in the backward direction, i.e. up the flutes. The chamfer lead length is designed in such a way so that during the return movement chips do not jam and are reliably sheared off.

The tapping of aluminum, grey cast iron and brass requires taps with a short chamfer lead length, regardless of whether through or blind holes are required. In these materials a long chamfer lead length would act as a core drill with chip breaker grooves and would only drill the tapping size hole to the major diameter instead of cutting a thread.

Straight fluted taps without spiral point are general purpose tools and have the disadvantage of not showing optimum results in particular materials. It's well worth the effort to take the trouble of ascertaining the most suitable tool for any given metal-cutting task.

Chamfer forms to DIN 2197

Form A

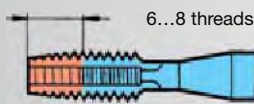

long, 6 - 8 threads
for short
through holes

Form B

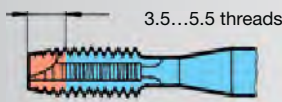

medium, 3.5 - 5.5 threads,
with spiral point,
for all through holes
in medium and long-chipping materials

Form C

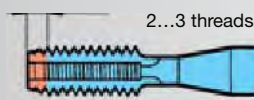

short, 2 - 3 threads
for blind holes
and generally for
aluminum, grey cast iron
and brass

Form D

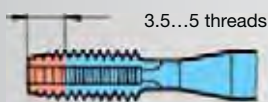

medium, 3.5 - 5 threads
for short
through holes and blind holes
where tap drill clearance permits.

Form E

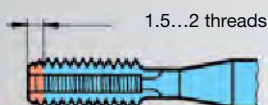

extremely short, 1.5-2 threads,
for blind holes with
little run-out depth.
Avoid use if possible.

Form F

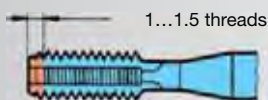

extremely short, 1-1.5 threads,
for blind holes with
little run-out depth.
Avoid use if possible.

Technical Information

Tap Tolerances and Approximate Limits

UNC/UNF Taps

Screw size and fractional threads are typically specified as one of three classes of fit. Class 1B – for low precision, or threads that are typically used in areas where dirt and grime are a constant factor; Class 2B for general threading applications (by far the most common); and Class 3B for precision threads generally found in medical, aerospace and applicable automotive applications.

- As seen in the chart – these classes of fit do overlap even though they are progressive in accuracy. To further break down the accuracy of these threads we have “H” limits in increments of 0.0005”.

- Every size/pitch tap has a specific or given basic pitch diameter that is the basis for the “H” limits and the class of fit for that size.

- As you can see in the chart – the class of fit will give you minimum and maximum pitch diameter limits that need to be maintained during manufacturing (typically these are your thread gauge limits). By seeing the “H” limits illustrated you are better able to understand what area of the class of fit you are actually working within. (This chart does not show a specific size tap – its purpose is to give a visual understanding of how the “H” limits work within the different classes of fit).

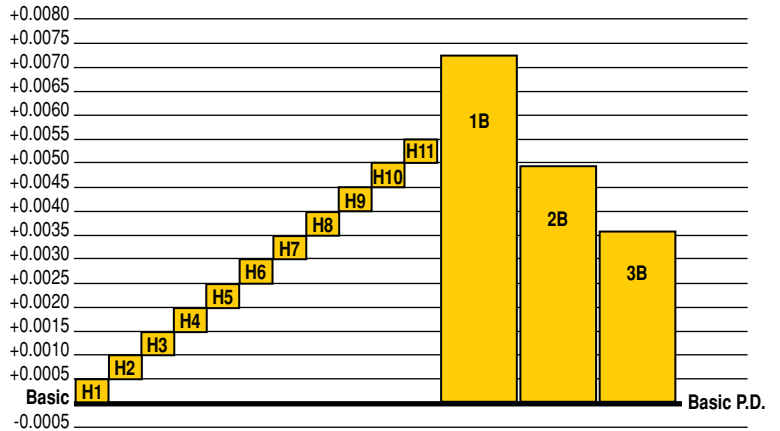

Metric Taps

Metric threads have their own classifications for class of fit and the thread limits within them. When discussing UNC/UNF threads we worked with 3B, 2B and 1B Classes of fit and had “H” limits which helped define the accuracy within each class. To help understand Metric tolerancing it may be easiest to look at the similarities between both Metric and Fractional tolerancing.

- A metric 6H class of fit is quite similar to the fractional 2B class of fit - as is the metric 4H to the fractional 3B. We will focus on the 6H class of fit as this is our standard offering in metric sizes. (Please note that special classes of fit can be produced for any given application upon request).

- Again – the class of fit will give you minimum and maximum pitch diameter limits that need to be maintained during manufacturing. Within the class of fit – metric thread limits are further broken down into “D” limits. Each “D” limit equals 0.013mm (0.013mm = 0.00051” – extremely similar to that of fractional “H” limit tolerancing).

- As you look at this chart you can see how the “D” limits help control what area of the class of fit you are working within. (This chart does not show a specific size tap – its purpose is to give a visual understanding of how the “D” limits work within a class of fit).

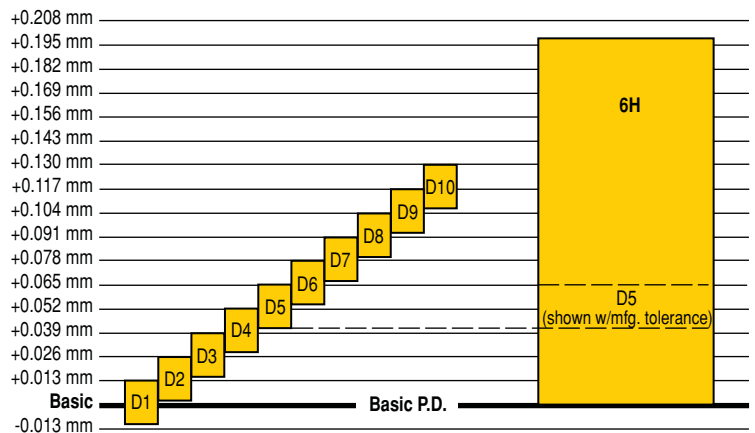

Taps for ISO metric threads DIN EN 22857 (extract)

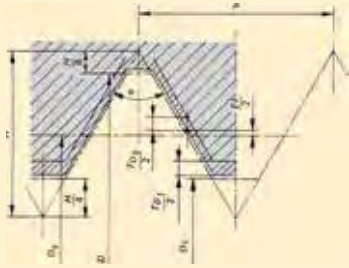

Profile of the nut thread

Basic profile:

- D major diameter
- D₁ nom. dia. of tapping size hole
- D₂ basic pitch diameter
- P pitch of diameter
- α included angle of thread
- H height of peak to peak thread profile
- EI basic deviation of pitch, zero with tolerance zone H, positive with tolerance zone G

Tolerances:

- T_{D1} tolerance on tapping size hole dia
- T_{D2} tolerance on tap pitch dia.

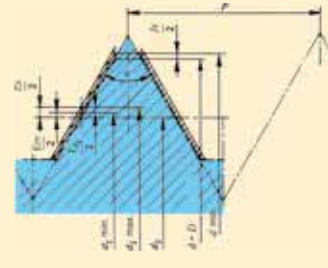

Profile of the tap

Basic profile:

- d=D major diameter
- d min. d min. permissible min. tap major dia.
- Js minimum clearance on major diameter
- d₂=D₂ basic pitch diameter
- d₂ min. minimum tap pitch diameter
- d₂ max. maximum tap pitch diameter
- Es upper deviation of pitch diameter
- Em lower deviation of pitch diameter

Tolerance:

- T_{d2} tolerance on tap pitch diameter

With the aim of unifying threads on an international basis, the ISO thread was brought out and has been accepted by all concerned. Today the ISO metric thread is the most common type. As you can see, our tap program demonstrates this fact in the clearest possible way.

Metric tolerance qualities (figure identification)

Tolerance qualities of external threads are defined by the table to the right, those of nut threads by the table on the lower right.

Tolerance positions (letter identification)

ISO metric internal threads are identified by capital letters A to H, ISO metric external threads by small letters a to h. Tolerance zones A to G have positive and a to g negative basic pitch deviations in contrast to the tolerance zones H and h which commence at zero. Generally, tolerance zones H and g are used. For threads destined for surface treatment tolerance zones G and e are applied.

When manufacturing ISO-external threads the deviations that are determined for the major diameter with regard to the tolerance zones a to g have to be taken into account.

Tolerance zones (nut thread)/ Tolerance classes (tap thread)

Quality and position of tolerance determine the tolerance zone, which is identified by the appropriate figures and letters. The abbreviation for the tolerance class of tap corresponds to the tolerance zone of the internal thread for which the tap is used in most cases. Therefore, it is not identical with the tolerance zone of the cut nut thread in every application. Taps with deviating tolerances according to DIN 802 part 1 will be given additional marking "X" (6 HX, 6 GX).

We recommend the application of taps in accordance with the adjacent table:

Tolerance zone / tolerance class allocation

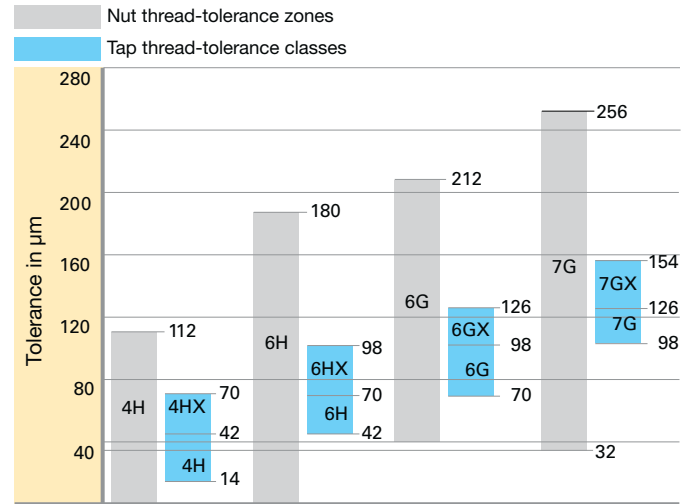

DIN EN 22857		Tolerance zone of internal thread to be cut				DIN 802 part 1 (withdrawn)	
Application class of tap	Designation* Reference	4H	5H	6H	6G	7G	Tolerance class of tap
Class 1	ISO 1	4H					4H
Class 2	ISO 2			6H			6H
Class 3	ISO 3				6G		6G
-	-					7G	7G

* The tolerance of the 3 application classes is calculated in accordance to the following data dependent on one tolerance unit t the value of which corresponds to the value of the basic pitch diameter TD2 in tolerance class 5 of the nut thread (polished to a pitch of 0.2 mm):
t = t_{D2} Tolerance class 5 of nut thread

Taps for ISO metric threads DIN EN 22857 (extract)

Thread clearances and fits

Fits between internal and external threads are separated by a diagonal stroke, as for example 6H/6g (internal/external thread). The fit has to be selected in conjunction with the appropriate thread connection.

The tolerance zones of the tolerance classes fine, medium and coarse are allocated to three screw-in lengths short S), normal (N) and long (L). Generally, the following rules apply for selecting a tolerance class:

Fine tolerance zone (S):

For precision threads, when only a small variation in the fit is permitted.

Medium tolerance zone (N):

General application

Coarse tolerance zone (L):

There are no special precision requirements and in cases where production difficulties may occur, e.g. thread production in hot-rolled rods, deep blind holes or plastic components.

Screw-in lengths:

The quality of thread connection is also affected by the screw-in length. The ISO tolerance system was, especially as regards the pitch diameter, divided into three groups, i.e.

S (Short)	= short screw-in length
N (Normal)	= normal screw-in length
L (Long)	= long screw-in length

The following fit should be selected for normal screw-in length N: To ensure a tighter fit of thread connections, we recommend for short screw-in lengths a narrower fit. As far as long screw-in lengths are concerned, fits with a larger tolerance must be used to compensate for pitch deviations.

Thread fits with different flank clearance

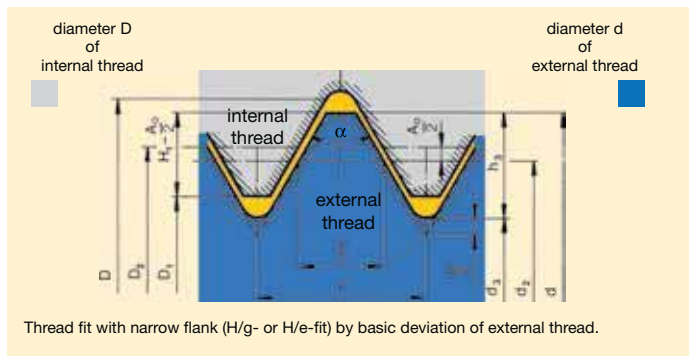
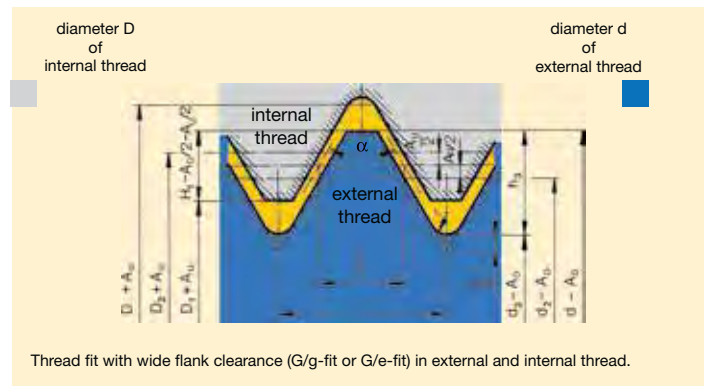
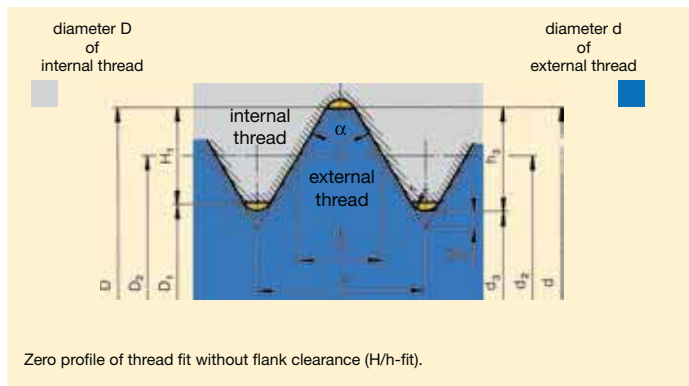

Explanation of symbols

D	=	Ø nom. of internal thread
D ₁	=	Tapping size hole Ø of internal thread
D ₂	=	Basic pitch Ø of internal thread
d	=	Ø nom. of external thread
d ₂	=	Basic pitch Ø of external thread
d ₃	=	Tapping size hole Ø of external thread
P	=	Pitch
α	=	Included angle of thread
H	=	Height of peak to peak thread profile
A ₀	=	Upper tolerance limit
A ₀	=	Lower tolerance limit

Technical Information

Cutting rate recommendations for **CUT** taps

Material group		Approximate Rc	Approximate HB	Recommended SFM					
				HSS-E		HSS-E-PM		Solid carbide	
				bright finish	hard coated	bright finish	hard coated	bright finish	hard coated
● Structural steels, free-cutting steels Unalloyed case hardened steels Unalloyed heat-treatable steels			<180	30-50	40-70	50-70	55-95	-	-
		<20	<230	20-40	30-70	40-65	40-80	-	-
		<25	<250	15-35	25-50	30-60	35-75	-	-
● Structural steels, free-cutting steels Case hardened steels, heat-treatable steels Nitriding steels, spheroidal graphite iron		<20	<230	40-50	40-75	40-65	40-80	-	-
		<25	<250	30-45	30-65	30-60	35-75	-	-
		<30	<280	20-30	30-55	30-50	35-65	-	-
		<35	<320	15-25	20-35	25-45	30-60	-	-
		<38	<380	10-25	20-40	20-45	30-55	-	-
● Stainless- and acid-resistant steels, sulphured austenitic martensitic			<180	25-35	40-55	30-55	35-70	-	-
		<25	<250	20-30	30-40	30-50	35-60	-	-
		<30	<280	20-30	25-40	25-45	30-50	-	-
		<35	<320	10-20	20-30	20-35	25-50	-	-
● Alloyed case hardened steels Alloyed heat-treatable steels Alloyed tool steels High speed tool steels		<25	<250	10-20	30-40	30-50	35-70	-	-
		<30	<280	25-35	30-50	25-45	35-65	-	-
		<35	<320	15-30	20-40	20-45	30-60	-	-
		<38	<380	8-15	10-30	15-35	25-55	-	-
		<44	<415	-	-	4-10	8-15	4-8	8-16
		<60		-	-	-	4-10	3-6	6-12
● Cast iron Spheroidal graphite iron Malleable cast iron			<180	50-70	60-90	55-85	65-110	70-100	80-130
		<25	<250	30-50	45-85	40-70	60-100	70-100	80-130
		<35	<320	15-35	20-40	25-45	35-55	60-110	70-120
● Aluminum and Al-alloys		SILICON CONTENT	WROUGHT ALUMINUM						
		< 6%	n/a	30-50	50-75	50-70	65-80	80-140	90-165
		6-10%	n/a	25-35	40-50	40-65	65-80	80-140	90-165
		>10%	n/a	-	25-35	40-65	65-80	60-130	80-140
		n/a	30-80	50-65	65-100	-	-	-	-
		n/a	75-150	35-60	50-65	-	-	-	-
● Titanium and Ti-alloys			140-275	-	-	12-25	20-30	-	-
			300-380	-	-	6-12	10-18	-	-
● Nickel and Ni-alloys			200-300	-	-	6-12	10-18	-	-
			>300	-	-	3-6	6-12	-	-
Plastics			15-30	-	20-40	-	30-60	-	
Magnesium-alloys			90-140	-	-	-	110-180	-	
Brass, short-chipping long-chipping			30-45	-	45-60	-	80-100	-	
			30-45	-	45-60	-	80-100	-	

Technical Information

Cutting Speeds Conversion for Taps

Tap Sizes	Surface Feet per Minute																	
	5'	10'	15'	20'	25'	30'	40'	50'	60'	70'	80'	90'	100'	110'	120'	130'	140'	150'
	Revolutions per Minute																	
UNC/UNF Taps																		
No. 2	212	424	637	888	1110	1333	1777	2221	2665	3109	3554	3999	4442	4886	5330	5774	6218	6662
No. 3	191	382	573	772	964	1157	1543	1929	2315	2701	3086	3472	3858	4244	4629	5015	5401	5787
No. 4	174	347	521	682	853	1023	1364	1705	2046	2387	2728	3069	3411	3751	4092	4434	4775	5116
No. 5	147	294	441	611	764	917	1222	1528	1833	2139	2445	2750	3056	3361	3667	3973	4278	4584
No. 6	136	273	409	553	691	829	1106	1382	1659	1935	2212	2488	2766	3042	3318	3595	3871	4148
No. 8	119	239	358	466	583	699	932	1165	1398	1631	1864	2097	2330	2563	2796	3029	3262	3495
No. 10	101	201	302	402	502	603	804	1005	1205	1406	1607	1808	2009	2210	2411	2612	2813	3014
No. 12	87	174	260	354	442	531	707	884	1061	1238	1415	1592	1769	1945	2122	2300	2476	2653
1/4	76	153	229	306	382	458	611	764	917	1070	1222	1375	1528	1681	1833	1968	2139	2292
5/16	62	123	185	245	306	367	489	611	733	856	978	1100	1222	1345	1467	1589	1711	1833
3/8	50	101	151	204	255	305	407	509	611	713	815	917	1019	1120	1222	1324	1426	1528
7/16	43	87	130	175	219	262	349	437	524	611	698	786	873	960	1048	1135	1222	1310
1/2	38	76	115	153	191	229	305	382	458	535	611	688	764	840	917	993	1070	1146
9/16	34	68	102	137	172	206	274	342	410	478	547	616	683	752	820	888	952	1020
5/8	32	64	96	122	153	183	244	306	367	428	489	550	611	672	733	794	856	917
11/16	28	55	83	111	138	167	222	278	333	389	444	500	556	611	667	722	778	833
3/4	25	51	76	102	128	153	203	255	305	357	407	458	509	560	611	662	713	764
7/8	22	43	65	87	109	131	175	218	262	306	350	392	437	480	524	568	611	655
1	19	38	57	76	96	115	153	191	230	268	305	344	382	420	458	497	535	573
1 1/8	17	34	51	68	84	102	136	170	204	238	272	306	340	373	407	441	475	509
1 1/4	15	31	46	61	76	92	122	153	183	214	244	275	305	336	367	397	428	458
1 3/8	14	28	42	56	69	83	111	139	167	194	222	250	278	306	333	361	389	417
1 1/2	13	25	38	51	63	76	102	127	153	178	204	229	255	280	305	331	356	382
Metric Taps																		
M 2.0	242	484	725	967	1209	1451	1934	2418	2901	3385	3868	4352	4835	5319	5803	6286	6770	7253
M 3.0	162	324	486	647	809	971	1295	1619	1942	2266	2590	2914	3237	3561	3885	4208	4532	4856
M 3.5	138	277	415	554	692	830	1107	1384	1661	1938	2214	2491	2768	3045	3322	3599	3875	4152
M 4.0	122	243	365	487	608	730	973	1217	1460	1703	1946	2190	2433	2676	2920	3163	3406	3650
M 5.0	97	194	291	388	485	582	776	970	1163	1357	1551	1745	1939	2133	2327	2521	2715	2909
M 6.0	81	162	243	324	405	486	647	809	971	1133	1295	1457	1619	1781	1942	2104	2266	2428
M 7.0	69	138	208	277	346	415	554	692	830	969	1107	1246	1384	1522	1661	1799	1938	2076
M 8.0	61	121	182	243	303	364	485	606	728	849	970	1091	1213	1334	1455	1577	1698	1819
M 10.0	48	97	145	194	242	291	388	485	582	679	776	873	970	1067	1163	1260	1357	1454
M 12.0	40	81	121	162	202	243	324	405	486	567	647	728	809	890	971	1052	1133	1214
M 14.0	35	69	104	139	173	208	277	347	416	485	555	624	693	763	832	901	971	1040
M 16.0	30	61	91	121	152	182	243	303	364	424	485	546	606	667	728	788	849	910
M 18.0	27	54	81	108	135	162	216	269	323	377	431	485	539	593	647	700	754	808
M 20.0	24	49	73	97	121	146	194	243	291	340	388	437	485	534	582	631	680	728
M 22.0	22	44	66	88	110	132	176	221	265	309	353	397	441	485	529	573	618	662
M 24.0	20	40	61	81	101	121	162	202	243	283	323	364	404	445	485	526	566	606
M 27.0	18	36	54	72	90	108	144	180	216	252	287	323	359	395	431	467	503	539
M 30.0	16	32	49	65	81	97	129	162	194	226	259	291	323	356	388	420	453	485

Technical Information

DIN characteristic features for taps

Master standards for dimensions to DIN 2184

The standard DIN 2184 stipulates the major dimensions for taps and fluteless taps required for the thread production with nominal diameter $d_1 > 0.9 \dots 113 \text{ mm}$. Part 1 is the master standard for dimensions for a long tool design, part 2 the master standard for dimensions for the short tool design. According to the nominal diameter range and dependent

on the pitch, the number of teeth and the ratio total length these master standards include: the max. thread length, the shank designs "reinforced shank" and "reduced shank". A detailed illustration of shank designs and characteristic features can be found below.

Taps

DIN 2184-1		DIN 2184-1	
Machine taps, long		Hand taps and machine taps, short	
ISO metric thread	ISO metric fine thread	ISO metric thread	ISO metric fine thread
DIN 371 DIN 376	DIN 371 DIN 374	DIN 352	DIN 2181
UNC/BSW* thread	UNF thread	G-thread	Pg thread
~DIN 371 ~DIN 376	~DIN 371 ~DIN 374	DIN 5156	~DIN 352 ~DIN 2181 DIN 5157 DIN 40 432

Fluteless Taps

DIN 2184-1				
DIN 2174		DIN 2184-1		
ISO metric thread	ISO metric fine thread	UNC thread	UNF thread	G thread
previously DIN 371 DIN 376	previously DIN 371 DIN 374	previously ~DIN 371 ~DIN 376	previously ~DIN 371 ~DIN 374	previously DIN 5156

Shank designs for thread cutting tools

Thread type	DIN		contained in the master standards	Nominal diameter ranges mm			
	Taps	Fluteless taps		0.9 ... 2.6	>2.6 ... 6.35	>6.35 ... 10.0	>10.0
M ISO metric threads	DIN 371		2184-1	●	●	●	—
	DIN 376		2184-1	●	●	●	●
	DIN 352		2184-2	●	●	●	●
	DIN 2174		2184-1	●	●	●	●
MF ISO metric fine threads	DIN 371		2184-1	●	●	●	—
	DIN 374		2184-1	—	●	●	●
	DIN 2181		2184-2	●	●	●	●
	DIN 2174		2184-1	●	●	●	●
UNC/BSW threads	~DIN 371		2184-1	●	●	●	—
	~DIN 376		2184-1	●	●	●	●
	~DIN 352		2184-2	●	●	●	●
UNF threads	~DIN 371		2184-1	●	●	●	—
	~DIN 374		2184-1	—	●	●	●
	~DIN 2181		2184-2	●	●	●	●



Characteristic features of the individual standards

DIN 371
in the master standard
DIN 2184-1

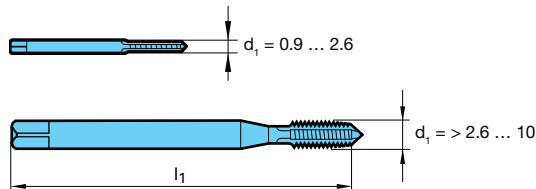

Standard for machine taps with reinforced shank for standard ISO metric threads and ISO metric fine threads. Long design. Shank design in accordance with diameter ranges shown above (mm).

DIN 376
in the master standard
DIN 2184-1

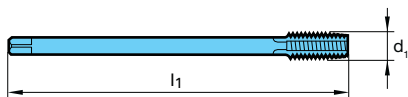

Standard for machine taps with reduced shank for standard ISO metric threads. Long design. Diameter range $d_1 = 1.6 \dots 68 \text{ mm}$ ($\leq \text{Ø M3}$, shank without square)

DIN 374
in the master standard
DIN 2184-1

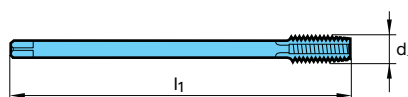

Standard for machine taps with reduced shank for ISO metric fine threads. Long design. Diameter range $d_1 = 3 \dots 52 \text{ mm}$

Technical Information

Guhring Substrate and Coating Descriptions

High speed steels

Only high quality tool materials are used to produce HSS tools. Systematic selection of alloying elements ensure the tool possesses the optimal characteristics for the individual tasks. These elements include:

- Tungsten, Molybdenum: increase heat- and wear-resistance
- Vanadium: increases wear-resistance of finishing tools
- Cobalt: enables increased hardening temperatures and heat-resistance.

Carbide

Carbide, similar to steel, is a less than precise and indeed a very general term for an entire material group. Carbide can be produced in an infinite number of variations with different characteristics through the combination of at least two basic constituents.

Carbide production

Carbide consists of a hardness carrier – tungsten carbide plus maybe one or more carbides – and an extremely tough component: Cobalt (Co). Cobalt basically serves as a cementing or binding agent in which the carbide particles are distributed.

Our carbide division has a state-of-the-art laboratory at its disposal to ensure our carbide always corresponds with customer requirements. From the raw material to the finished product, samples are continuously examined in order to guarantee and document the highest quality and process reliability in accordance with the certification.

High-performance thin-film PVD coatings from Guhring

	Type	Identifying Color	Coating Process	Coating Temperature	Layer Structure	Thickness (µm)	Nano-hardness (HV 0.05)	Friction Coefficient (fetting)	Thermal Stability
TiN Titanium Nitride	Hard • Wear-resistant	Gold	PVD Physical Vapor Deposition	930° F 500° C	Monolayer	1.5 - 4.0	2400	0.50	1100° F 595° C
TiCN Titanium Carbonitride	Hard • Wear-resistant	Gray Violet	PVD Physical Vapor Deposition	930° F 500° C	Gradient	1.5 - 5.0	3000	0.25	840° F 450° C
TiAlN Titanium Aluminum Nitride	Hard • Wear-resistant	Black Violet	PVD Physical Vapor Deposition	930° F 500° C	Monolayer	1.5 - 4.0	3300	0.50	1470° F 800° C
FIREX® Special TiN-TiAlN	Hard • Wear-resistant	Red Violet	PVD Physical Vapor Deposition	930° F 500° C	Multilayer	1.5 - 5.0	3000-3300	0.50	1470° F 800° C
nano-FIREX® Special TiN-TiAlN	Hard • Wear-resistant	Red Violet	PVD Physical Vapor Deposition	930° F 500° C	Multilayer	1.5 - 4.0	3000-3300	0.50	1470° F 800° C
Super-A™ Aluminum Titanium Nitride	Hard • Wear-resistant	Dark Gray	PVD Physical Vapor Deposition	930° F 500° C	Monolayer	1.5 - 4.0	3800	0.60	1650° F 900° C
nano-A™ Aluminum Titanium Nitride	Hard • Wear-resistant	Dark Gray	PVD Physical Vapor Deposition	930° F 500° C	Monolayer	1.5 - 4.0	3800	0.60	1650° F 900° C
MolyGlide® MoS ₂ -Based	Soft • Lubri- cating	Silver	PVD Physical Vapor Deposition	305° F 150° C	Monolayer	1.0	n.a.	0.10	1470° F 800° C

Technical Information

UNC / UNF Tap Drill Sizes

81-59% Theoretical Percentage of Thread						
Tap Size	dec	Fract	Wire/Let	mm	Theor %	
0-80	0.0468	3/64		1.189	81	
0-80	0.0472				1.199	79
0-80	0.0473				1.201	78
0-80	0.0477				1.212	76
0-80	0.0478				1.214	75
0-80	0.0480				1.219	74
0-80	0.0483				1.227	72
0-80	0.0485				1.232	71
0-80	0.0488				1.240	69
0-80	0.0490				1.245	68
0-80	0.0493				1.252	66
0-80	0.0494				1.255	65
0-80	0.0499				1.267	62
0-80	0.0503				1.278	60
0-80	0.0504				1.280	59
1-64	0.0566				1.438	81
1-64	0.0570			1.448	79	
1-64	0.0572			1.453	78	
1-64	0.0576			1.463	76	
1-64	0.0578			1.468	75	
1-64	0.0580			1.473	74	
1-64	0.0584			1.483	72	
1-64	0.0586			1.488	71	
1-64	0.0590			1.499	69	
1-64	0.0592			1.504	68	
1-64	0.0596			1.514	66	
1-64	0.0598			1.519	65	
1-64	0.0604			1.534	62	
1-64	0.0608			1.544	60	
1-64	0.0610			1.549	59	
1-72	0.0584			1.483	81	
1-72	0.0587			1.491	79	
1-72	0.0589			1.496	78	
1-72	0.0593			1.506	76	
1-72	0.0595		#53	1.511	75	
1-72	0.0596			1.514	74	
1-72	0.0600			1.524	72	
1-72	0.0602			1.529	71	
1-72	0.0606			1.539	69	
1-72	0.0607			1.542	68	
1-72	0.0611			1.552	66	
1-72	0.0613			1.557	65	
1-72	0.0618			1.570	62	
1-72	0.0622			1.580	60	
1-72	0.0625	1/6		1.588	59	
2-56	0.0672			1.707	81	
2-56	0.0677			1.720	79	
2-56	0.0679			1.725	78	
2-56	0.0684			1.737	76	
2-56	0.0686			1.742	75	
2-56	0.0688			1.748	74	
2-56	0.0693			1.760	72	
2-56	0.0695			1.765	71	
2-56	0.0700			1.778	69	
2-56	0.0702			1.783	68	
2-56	0.0707			1.796	66	
2-56	0.0709			1.801	65	
2-56	0.0716			1.819	62	
2-56	0.0721			1.831	60	
2-56	0.0723			1.836	59	
2-64	0.0696			1.768	81	
2-64	0.0700		#50	1.778	79	
2-64	0.0702			1.783	78	
2-64	0.0706			1.793	76	
2-64	0.0708			1.798	75	
2-64	0.0710			1.803	74	
2-64	0.0714			1.814	72	
2-64	0.0716			1.819	71	
2-64	0.0720			1.829	69	
2-64	0.0722			1.834	68	
2-64	0.0726			1.844	66	
2-64	0.0728			1.849	65	
2-64	0.0734			1.864	62	
2-64	0.0738			1.875	60	
2-64	0.0740			1.880	59	
3-48	0.0772			1.960	81	
3-48	0.0776			1.970	79	
3-48	0.0780	5/64		1.980	78	
3-48	0.0783		47	1.990	76	
3-48	0.0787			2.000	75	
3-48	0.0791			2.010	74	
3-48	0.0795			2.020	72	
3-48	0.0799			2.030	71	
3-48	0.0803			2.040	69	
3-48	0.0807			2.050	68	
3-48	0.0811		46	2.060	66	
3-48	0.0815			2.070	65	
3-48	0.0819		45	2.080	63	
3-48	0.0823			2.090	62	
3-48	0.0827			2.100	60	
3-48	0.0831			2.110	59	

81-59% Theoretical Percentage of Thread					
Tap Size	dec	Fract	Wire/Let	mm	Theor %
3-56	0.0803			2.040	81
3-56	0.0807			2.050	79
3-56	0.0811		46	2.060	77
3-56	0.0815			2.070	75
3-56	0.0819		45	2.080	74
3-56	0.0823			2.090	72
3-56	0.0827			2.100	70
3-56	0.0831			2.110	69
3-56	0.0835			2.120	67
3-56	0.0839			2.130	65
3-56	0.0843			2.140	63
3-56	0.0846			2.150	62
3-56	0.0850			2.160	60
3-56	0.0854			2.170	59
4-40	0.0858		44	2.180	81
4-40	0.0862			2.190	79
4-40	0.0866			2.200	78
4-40	0.0870			2.210	77
4-40	0.0874			2.220	76
4-40	0.0878			2.230	75
4-40	0.0882			2.240	73
4-40	0.0886			2.250	72
4-40	0.0890		43	2.260	71
4-40	0.0894			2.270	70
4-40	0.0898			2.280	68
4-40	0.0902			2.290	67
4-40	0.0906			2.300	66
4-40	0.0909			2.310	65
4-40	0.0913			2.320	64
4-40	0.0917			2.330	63
4-40	0.0921			2.340	61
4-40	0.0925			2.350	60
4-40	0.0929			2.360	59
4-48	0.0902			2.290	81
4-48	0.0906			2.300	79
4-48	0.0909			2.310	78
4-48	0.0913			2.320	76
4-48	0.0917			2.330	75
4-48	0.0921			2.340	74
4-48	0.0925			2.350	72
4-48	0.0929			2.360	71
4-48	0.0933		42	2.370	69
4-48	0.0937	3/32		2.380	68
4-48	0.0941			2.390	66
4-48	0.0945			2.400	65
4-48	0.0949			2.410	63
4-48	0.0953			2.420	62
4-48	0.0957			2.430	60
4-48	0.0961		41	2.440	59
5-40	0.0988			2.510	81
5-40	0.0992			2.520	79
5-40	0.0996		39	2.530	78
5-40	0.1000			2.540	77
5-40	0.1004			2.550	76
5-40	0.1008			2.560	75
5-40	0.1012			2.570	73
5-40	0.1016		38	2.580	72
5-40	0.1020			2.590	71
5-40	0.1024			2.600	70
5-40	0.1028			2.610	68
5-40	0.1031			2.620	67
5-40	0.1035			2.630	66
5-40	0.1039		37	2.640	65
5-40	0.1043			2.650	64
5-40	0.1047			2.660	63
5-40	0.1051			2.670	61
5-40	0.1055			2.680	60
5-40	0.1059			2.690	59
5-44	0.1012			2.570	81
5-44	0.1016		38	2.580	79
5-44	0.1020			2.590	78
5-44	0.1024			2.600	77
5-44	0.1028			2.610	75
5-44	0.1031			2.620	74
5-44	0.1035			2.630	73
5-44	0.1039		37	2.640	71
5-44	0.1043			2.650	70
5-44	0.1047			2.660	69
5-44	0.1051			2.670	67
5-44	0.1055			2.680	66
5-44	0.1059			2.690	65
5-44	0.1063			2.700	63
5-44	0.1067		36	2.710	62
5-44	0.1071			2.720	61
5-44	0.1075			2.730	59
6-32	0.1051			2.670	81
6-32	0.1055			2.680	80
6-32	0.1059			2.690	79
6-32	0.1063			2.700	78
6-32	0.1067		36	2.710	77
6-32	0.1071			2.720	76

Technical Information

UNC / UNF Tap Drill Sizes

81-59% Theoretical Percentage of Thread					
Tap Size	dec	Fract	Wire/Let	mm	Theor %
6-32	0.1075			2.730	75
6-32	0.1079			2.740	74
6-32	0.1083			2.750	73
6-32	0.1087			2.760	72
6-32	0.1091			2.770	71
6-32	0.1094	7/64		2.780	70
6-32	0.1098		35	2.790	69
6-32	0.1102			2.800	68
6-32	0.1106			2.810	67
6-32	0.1110		34	2.820	67
6-32	0.1114			2.830	66
6-32	0.1118			2.840	65
6-32	0.1122			2.850	64
6-32	0.1126			2.860	63
6-32	0.1130		33	2.870	62
6-32	0.1134			2.880	61
6-32	0.1138			2.890	60
6-32	0.1142			2.900	59
6-40	0.1118			2.840	81
6-40	0.1122			2.850	79
6-40	0.1126			2.860	78
6-40	0.1130		33	2.870	77
6-40	0.1134			2.880	76
6-40	0.1138			2.890	75
6-40	0.1142			2.900	73
6-40	0.1146			2.910	72
6-40	0.1150			2.920	71
6-40	0.1154			2.930	70
6-40	0.1157			2.940	69
6-40	0.1161		32	2.950	67
6-40	0.1165			2.960	66
6-40	0.1169			2.970	65
6-40	0.1173			2.980	64
6-40	0.1177			2.990	63
6-40	0.1181			3.000	61
6-40	0.1185			3.010	60
6-40	0.1189			3.020	59
8-32	0.1311			3.330	81
8-32	0.1315			3.340	80
8-32	0.1319			3.350	79
8-32	0.1323			3.360	78
8-32	0.1327			3.370	77
8-32	0.1331			3.380	76
8-32	0.1335			3.390	75
8-32	0.1339			3.400	74
8-32	0.1343			3.410	73
8-32	0.1346			3.420	72
8-32	0.1350			3.430	71
8-32	0.1354			3.440	70
8-32	0.1358		29	3.450	69
8-32	0.1362			3.460	68
8-32	0.1366			3.470	67
8-32	0.1370			3.480	67
8-32	0.1374			3.490	66
8-32	0.1378			3.500	65
8-32	0.1382			3.510	64
8-32	0.1386			3.520	63
8-32	0.1390			3.530	62
8-32	0.1394			3.540	61
8-32	0.1398			3.550	60
8-32	0.1402			3.560	59
8-36	0.1346			3.420	81
8-36	0.1350			3.430	80
8-36	0.1354			3.440	79
8-36	0.1358		29	3.450	78
8-36	0.1362			3.460	77
8-36	0.1366			3.470	76
8-36	0.1370			3.480	75
8-36	0.1374			3.490	74
8-36	0.1378			3.500	73
8-36	0.1382			3.510	72
8-36	0.1386			3.520	70
8-36	0.1390			3.530	69
8-36	0.1394			3.540	68
8-36	0.1398			3.550	67
8-36	0.1402			3.560	66
8-36	0.1406	9/64	28	3.570	65
8-36	0.1409			3.580	64
8-36	0.1413			3.590	63
8-36	0.1417			3.600	62
8-36	0.1421			3.610	61
8-36	0.1425			3.620	60
10-24	0.1461			3.710	81
10-24	0.1465			3.720	80
10-24	0.1469		26	3.730	80
10-24	0.1472			3.740	79
10-24	0.1476			3.750	78
10-24	0.1480			3.760	78
10-24	0.1484			3.770	77
10-24	0.1488			3.780	76
10-24	0.1492			3.790	75

81-59% Theoretical Percentage of Thread					
Tap Size	dec	Fract	Wire/Let	mm	Theor %
10-24	0.1496		25	3.800	75
10-24	0.1500			3.810	74
10-24	0.1504			3.820	73
10-24	0.1508			3.830	72
10-24	0.1512			3.840	72
10-24	0.1516			3.850	71
10-24	0.1520		24	3.860	70
10-24	0.1524			3.870	69
10-24	0.1528			3.880	69
10-24	0.1531			3.890	68
10-24	0.1535			3.900	67
10-24	0.1539		23	3.910	67
10-24	0.1543			3.920	66
10-24	0.1547			3.930	65
10-24	0.1551			3.940	64
10-24	0.1555			3.950	64
10-24	0.1559			3.960	63
10-24	0.1563	5/32		3.970	62
10-24	0.1567			3.980	62
10-24	0.1571		22	3.990	61
10-24	0.1575			4.000	60
10-24	0.1579			4.010	59
10-24	0.1583			4.020	59
10-32	0.1571		22	3.990	81
10-32	0.1575			4.000	80
10-32	0.1579			4.010	79
10-32	0.1583			4.020	78
10-32	0.1587			4.030	77
10-32	0.1591		21	4.040	76
10-32	0.1594			4.050	75
10-32	0.1598			4.060	74
10-32	0.1602			4.070	73
10-32	0.1606			4.080	72
10-32	0.1610		20	4.090	71
10-32	0.1614			4.100	70
10-32	0.1618			4.110	69
10-32	0.1622			4.120	68
10-32	0.1626			4.130	67
10-32	0.1630			4.140	67
10-32	0.1634			4.150	66
10-32	0.1638			4.160	65
10-32	0.1642			4.170	64
10-32	0.1646			4.180	63
10-32	0.1650			4.190	62
10-32	0.1654			4.200	61
10-32	0.1657			4.210	60
10-32	0.1661		19	4.220	59
12-24	0.1720	11/64		4.370	81
12-24	0.1724			4.380	81
12-24	0.1728		17	4.390	80
12-24	0.1732			4.400	79
12-24	0.1736			4.410	78
12-24	0.1740			4.420	78
12-24	0.1744			4.430	77
12-24	0.1748			4.440	76
12-24	0.1752			4.450	75
12-24	0.1756			4.460	75
12-24	0.1760			4.470	74
12-24	0.1764			4.480	73
12-24	0.1768			4.490	72
12-24	0.1772		16	4.500	72
12-24	0.1776			4.510	71
12-24	0.1780			4.520	70
12-24	0.1783			4.530	70
12-24	0.1787			4.540	69
12-24	0.1791			4.550	68
12-24	0.1795			4.560	67
12-24	0.1799		15	4.570	67
12-24	0.1803			4.580	66
12-24	0.1807			4.590	65
12-24	0.1811			4.600	64
12-24	0.1815			4.610	64
12-24	0.1819		14	4.620	63
12-24	0.1823			4.630	62
12-24	0.1827			4.640	62
12-28	0.1783			4.530	81
12-28	0.1787			4.540	80
12-28	0.1791			4.550	80
12-28	0.1795			4.560	79
12-28	0.1799		15	4.570	78
12-28	0.1803			4.580	77
12-28	0.1807			4.590	76
12-28	0.1811			4.600	75
12-28	0.1815			4.610	74
12-28	0.1819		14	4.620	74
12-28	0.1823			4.630	73
12-28	0.1827			4.640	72

Technical Information

UNC / UNF Tap Drill Sizes

81-59% Theoretical Percentage of Thread					
Tap Size	dec	Fract	Wire/Let	mm	Theor %
12-28	0.1831			4.650	71
12-28	0.1835			4.660	70
12-28	0.1839			4.670	69
12-28	0.1843			4.680	68
12-28	0.1846			4.690	68
12-28	0.1850		13	4.700	67
12-28	0.1854			4.710	66
12-28	0.1858			4.720	65
12-28	0.1862			4.730	64
12-28	0.1866			4.740	63
12-28	0.1870			4.750	63
12-28	0.1874	3/16		4.760	62
12-28	0.1878			4.770	61
12-28	0.1882			4.780	60
12-28	0.1886			4.790	59
1/4-20	0.1988			5.050	79
1/4-20	0.1992		8	5.060	78
1/4-20	0.2008			5.100	76
1/4-20	0.2012		7	5.110	75
1/4-20	0.2028			5.150	73
1/4-20	0.2031	13/64		5.160	72
1/4-20	0.2039		6	5.180	71
1/4-20	0.2047			5.200	70
1/4-20	0.2055		5	5.220	69
1/4-20	0.2067			5.250	67
1/4-20	0.2087			5.300	64
1/4-20	0.2091		4	5.310	63
1/4-20	0.2106			5.350	61
1/4-28	0.2126			5.400	81
1/4-28	0.2130		3	5.410	80
1/4-28	0.2146			5.450	76
1/4-28	0.2165			5.500	72
1/4-28	0.2185			5.550	68
1/4-28	0.2189	7/32		5.560	67
1/4-28	0.2205			5.600	64
1/4-28	0.2209		2	5.610	63
1/4-28	0.2224			5.650	59
5/16-18	0.2539			6.450	81
5/16-18	0.2559			6.500	78
5/16-18	0.2571		F	6.530	77
5/16-18	0.2579			6.550	76
5/16-18	0.2598			6.600	73
5/16-18	0.2610		G	6.630	71
5/16-18	0.2618			6.650	70
5/16-18	0.2638			6.700	67
5/16-18	0.2657	17/64	H	6.750	65
5/16-18	0.2677			6.800	62
5/16-18	0.2697			6.850	59
5/16-24	0.2697			6.850	79
5/16-24	0.2717		I	6.900	75
5/16-24	0.2736			6.950	72
5/16-24	0.2756			7.000	68
5/16-24	0.2768		J	7.030	66
5/16-24	0.2776			7.050	64
5/16-24	0.2795			7.100	61
3/8-16	0.3091			7.850	81
3/8-16	0.3110			7.900	79
3/8-16	0.3126	5/16		7.940	77
3/8-16	0.3130			7.950	76
3/8-16	0.3150			8.000	74
3/8-16	0.3161		O	8.030	73
3/8-16	0.3169			8.050	72
3/8-16	0.3189			8.100	69
3/8-16	0.3209			8.150	67
3/8-16	0.3228		P	8.200	64
3/8-16	0.3248			8.250	62
3/8-16	0.3268			8.300	59
3/8-24	0.3327			8.450	78
3/8-24	0.3346			8.500	75
3/8-24	0.3366			8.550	71
3/8-24	0.3386			8.600	67
3/8-24	0.3406			8.650	64
3/8-24	0.3425			8.700	60
7/16-14	0.3622			9.200	81
7/16-14	0.3642			9.250	79
7/16-14	0.3661			9.300	77
7/16-14	0.3677			9.340	75
7/16-14	0.3681		U	9.350	75
7/16-14	0.3701			9.400	73
7/16-14	0.3720			9.450	71
7/16-14	0.3740			9.500	68
7/16-14	0.3748	3/8		9.520	68
7/16-14	0.3760			9.550	66
7/16-14	0.3772		V	9.580	65
7/16-14	0.3780			9.600	64
7/16-14	0.3799			9.650	62
7/16-14	0.3819			9.700	60
7/16-20	0.3858		W	9.800	80
7/16-20	0.3878			9.850	77
7/16-20	0.3898			9.900	73
7/16-20	0.3906	25/64		9.920	72

81-59% Theoretical Percentage of Thread					
Tap Size	dec	Fract	Wire/Let	mm	Theor %
7/16-20	0.3917			9.950	71
7/16-20	0.3937			10.000	67
7/16-20	0.3957			10.050	64
7/16-20	0.3969		X	10.080	63
7/16-20	0.3976			10.100	61
1/2-13	0.4193			10.650	81
1/2-13	0.4213			10.700	79
1/2-13	0.4220	27/64		10.720	78
1/2-13	0.4232			10.750	77
1/2-13	0.4252			10.800	75
1/2-13	0.4272			10.850	73
1/2-13	0.4291			10.900	71
1/2-13	0.4311			10.950	69
1/2-13	0.4331			11.000	67
1/2-13	0.4350			11.050	65
1/2-13	0.4370			11.100	63
1/2-13	0.4374	7/16		11.110	63
1/2-13	0.4390			11.150	61
1/2-13	0.4409			11.200	59
1/2-20	0.4488			11.400	79
1/2-20	0.4508			11.450	76
1/2-20	0.4528			11.500	73
1/2-20	0.4531	29/64		11.510	72
1/2-20	0.4547			11.550	70
1/2-20	0.4567			11.600	67
1/2-20	0.4587			11.650	64
1/2-20	0.4606			11.700	61
9/16-12	0.4744			12.050	81
9/16-12	0.4764			12.100	80
9/16-12	0.4783			12.150	78
9/16-12	0.4803			12.200	76
9/16-12	0.4823			12.250	74
9/16-12	0.4843	31/64		12.300	72
9/16-12	0.4862			12.350	70
9/16-12	0.4882			12.400	69
9/16-12	0.4902			12.450	67
9/16-12	0.4921			12.500	65
9/16-12	0.4941			12.550	63
9/16-12	0.4961			12.600	61
9/16-12	0.4980			12.650	60
9/16-18	0.5039			12.800	81
9/16-18	0.5059			12.850	78
9/16-18	0.5079			12.900	76
9/16-18	0.5098			12.950	73
9/16-18	0.5118			13.000	70
9/16-18	0.5138			13.050	67
9/16-18	0.5157	33/64		13.100	65
9/16-18	0.5177			13.150	62
9/16-18	0.5197			13.200	59
5/8-11	0.5295			13.450	81
5/8-11	0.5311	17/32		13.490	80
5/8-11	0.5315			13.500	79
5/8-11	0.5335			13.550	77
5/8-11	0.5354			13.600	76
5/8-11	0.5374			13.650	74
5/8-11	0.5394			13.700	72
5/8-11	0.5413			13.750	71
5/8-11	0.5433			13.800	69
5/8-11	0.5453			13.850	67
5/8-11	0.5469	35/64		13.890	66
5/8-11	0.5472			13.900	66
5/8-11	0.5492			13.950	64
5/8-11	0.5512			14.000	62
5/8-11	0.5531			14.050	61
5/8-11	0.5551			14.100	59
5/8-18	0.5669			14.400	81
5/8-18	0.5689			14.450	78
5/8-18	0.5709			14.500	75
5/8-18	0.5728			14.550	72
5/8-18	0.5748			14.600	70
5/8-18	0.5768			14.650	67
5/8-18	0.5780	37/64		14.680	65
5/8-18	0.5787			14.700	64
5/8-18	0.5807			14.750	61
5/8-18	0.5827			14.800	59
3/4-10	0.6457			16.400	80
3/4-10	0.6476			16.450	79
3/4-10	0.6496			16.500	77
3/4-10	0.6516			16.550	76
3/4-10	0.6535			16.600	74
3/4-10	0.6555			16.650	73
3/4-10	0.6563	21/32		16.670	72
3/4-10	0.6575			16.700	71
3/4-10	0.6594			16.750	70
3/4-10	0.6614			16.800	68
3/4-10	0.6634			16.850	67
3/4-10	0.6654			16.900	65
3/4-10	0.6673			16.950	64
3/4-10	0.6693			17.000	62
3/4-10	0.6713			17.050	61
3/4-10	0.6720	43/64		17.070	60

Technical Information

UNC / UNF Tap Drill Sizes

81-59% Theoretical Percentage of Thread					
Tap Size	dec	Fract	Wire/Let	mm	Theor %
3/4-10	0.6732			17.100	59
3/4-16	0.6850			17.400	80
3/4-16	0.6870			17.450	78
3/4-16	0.6874	11/16		17.460	77
3/4-16	0.6890			17.500	75
3/4-16	0.6909			17.550	73
3/4-16	0.6929			17.600	70
3/4-16	0.6949			17.650	68
3/4-16	0.6969			17.700	65
3/4-16	0.6988			17.750	63
3/4-16	0.7008			17.800	61
7/8-9	0.7579			19.250	81
7/8-9	0.7598			19.300	80
7/8-9	0.7618			19.350	78
7/8-9	0.7638			19.400	77
7/8-9	0.7657	49/64		19.450	76
7/8-9	0.7677			19.500	74
7/8-9	0.7697			19.550	73
7/8-9	0.7717			19.600	72
7/8-9	0.7736			19.650	70
7/8-9	0.7756			19.700	69
7/8-9	0.7776			19.750	67
7/8-9	0.7795			19.800	66
7/8-9	0.7811	25/32		19.840	65
7/8-9	0.7815			19.850	65
7/8-9	0.7835			19.900	63
7/8-9	0.7854			19.950	62
7/8-9	0.7874			20.000	61
7/8-9	0.7894			20.050	59
7/8-14	0.8012			20.350	80
7/8-14	0.8031			20.400	77
7/8-14	0.8051			20.450	75
7/8-14	0.8071			20.500	73
7/8-14	0.8091			20.550	71
7/8-14	0.8110			20.600	69
7/8-14	0.8126	13/16		20.640	67
7/8-14	0.8130			20.650	67
7/8-14	0.8150			20.700	65
7/8-14	0.8169			20.750	63
7/8-14	0.8189			20.800	60
1-8	0.8681			22.050	81
1-8	0.8701			22.100	80
1-8	0.8720			22.150	79
1-8	0.8740			22.200	78
1-8	0.8748	7/8		22.220	77
1-8	0.8760			22.250	76
1-8	0.8780			22.300	75
1-8	0.8799			22.350	74
1-8	0.8819			22.400	73
1-8	0.8839			22.450	72
1-8	0.8858			22.500	70
1-8	0.8878			22.550	69
1-8	0.8898			22.600	68
1-8	0.8906	57/64		22.620	67
1-8	0.8917			22.650	67
1-8	0.8937			22.700	65
1-8	0.8957			22.750	64
1-8	0.8976			22.800	63
1-8	0.8996			22.850	62
1-8	0.9016			22.900	61
1-8	0.9035			22.950	59
1-12	0.9134			23.200	80
1-12	0.9154			23.250	78
1-12	0.9173			23.300	76
1-12	0.9193			23.350	75
1-12	0.9213			23.400	73
1-12	0.9220	59/64		23.420	72
1-12	0.9232			23.450	71
1-12	0.9252			23.500	69
1-12	0.9272			23.550	67
1-12	0.9291			23.600	65
1-12	0.9311			23.650	64
1-12	0.9331			23.700	62
1-12	0.9350			23.750	60
1-12	0.9370			23.800	58
1 1/8-7	0.9689	31/32		24.610	84
1 1/8-7	0.9724			24.700	82
1 1/8-7	0.9764			24.800	80
1 1/8-7	0.9803			24.900	78
1 1/8-7	0.9843	63/64		25.000	76
1 1/8-7	0.9882			25.100	74
1 1/8-7	0.9921			25.200	72
1 1/8-7	0.9961			25.300	69
1 1/8-7	1.0000	1		25.400	67
1 1/8-7	1.0039			25.500	65
1 1/8-7	1.0079			25.600	63
1 1/8-7	1.0118			25.700	61

81-59% Theoretical Percentage of Thread					
Tap Size	dec	Fract	Wire/Let	mm	Theor %
1 1/8-7	1.0157	1 1/64		25.800	59
1 1/8-7	1.0197			25.900	57
1 1/8-7	1.0236			26.000	55
1 1/8-12	1.0394			26.400	79
1 1/8-12	1.0433			26.500	75
1 1/8-12	1.0469	1 3/64		26.590	72
1 1/8-12	1.0472			26.600	72
1 1/8-12	1.0512			26.700	68
1 1/8-12	1.0551			26.800	65
1 1/8-12	1.0591			26.900	61
1 1/8-12	1.0626	1 1/16		26.990	58
1 1/8-12	1.0630			27.000	57
1 1/4-7	1.0937	1 3/32		27.780	84
1 1/4-7	1.1024			28.000	80
1 1/4-7	1.1063			28.100	77
1 1/4-7	1.1094	1 7/64		28.180	76
1 1/4-7	1.1102			28.200	75
1 1/4-7	1.1142			28.300	73
1 1/4-7	1.1181			28.400	71
1 1/4-7	1.1220			28.500	69
1 1/4-7	1.1248	1 1/8		28.570	67
1 1/4-7	1.1260			28.600	67
1 1/4-7	1.1299			28.700	65
1 1/4-7	1.1339			28.800	63
1 1/4-7	1.1378			28.900	60
1 1/4-7	1.1406	1 9/64		28.970	59
1 1/4-12	1.1614			29.500	82
1 1/4-12	1.1654			29.600	78
1 1/4-12	1.1693			29.700	75
1 1/4-12	1.1720	1 11/64		29.770	72
1 1/4-12	1.1732			29.800	71
1 1/4-12	1.1772			29.900	67
1 1/4-12	1.1811			30.000	64
1 1/4-12	1.1850			30.100	60
1 3/8-6	1.1969			30.400	82
1 3/8-6	1.2008			30.500	80
1 3/8-6	1.2031	1 13/64		30.560	79
1 3/8-6	1.2047			30.600	79
1 3/8-6	1.2087			30.700	77
1 3/8-6	1.2126			30.800	75
1 3/8-6	1.2165			30.900	73
1 3/8-6	1.2189	1 7/32		30.960	72
1 3/8-6	1.2205			31.000	71
1 3/8-6	1.2244			31.100	70
1 3/8-6	1.2283			31.200	68
1 3/8-6	1.2323			31.300	66
1 3/8-6	1.2343			31.350	65
1 3/8-6	1.2362			31.400	64
1 3/8-6	1.2402			31.500	62
1 3/8-6	1.2441			31.600	60
1 3/8-6	1.2480			31.700	59
1 3/8-12	1.2874			32.700	81
1 3/8-12	1.2913			32.800	77
1 3/8-12	1.2953			32.900	74
1 3/8-12	1.2969	1 19/64		32.940	72
1 3/8-12	1.2992			33.000	70
1 3/8-12	1.3031			33.100	66
1 3/8-12	1.3071			33.200	63
1 3/8-12	1.3110			33.300	59
1 1/2-6	1.3228			33.600	82
1 1/2-6	1.3268			33.700	80
1 1/2-6	1.3280	1 21/64		33.730	79
1 1/2-6	1.3307			33.800	78
1 1/2-6	1.3346			33.900	76
1 1/2-6	1.3386			34.000	75
1 1/2-6	1.3425			34.100	73
1 1/2-6	1.3437			34.130	72
1 1/2-6	1.3465			34.200	71
1 1/2-6	1.3504			34.300	69
1 1/2-6	1.3543			34.400	67
1 1/2-6	1.3583			34.500	65
1 1/2-6	1.3594			34.530	65
1 1/2-6	1.3622			34.600	64
1 1/2-6	1.3661			34.700	62
1 1/2-6	1.3701			34.800	60
1 1/2-6	1.3740			34.900	58
1 1/2-6	1.3748	1 3/8		34.920	58
1 1/2-12	1.4134			35.900	80
1 1/2-12	1.4173			36.000	76
1 1/2-12	1.4213			36.100	73
1 1/2-12	1.4220	1 27/64		36.120	72
1 1/2-12	1.4252			36.200	69
1 1/2-12	1.4291			36.300	65
1 1/2-12	1.4331			36.400	62
1 1/2-12	1.4370			36.500	58
1 1/2-12	1.4374	1 7/16		36.510	58

Technical Information

8-Pitch Tap Drill Sizes

81-59% Theoretical Percentage of Thread					
Tap Size	dec	Fract	Wire/Let	mm	Theor %
1 1/8-8	0.9935			25.25	81
1 1/8-8	0.9967			25.30	79
1 1/8-8	1.0000	1		25.40	77
1 1/8-8	1.0032			25.50	75
1 1/8-8	1.0081			25.60	72
1 1/8-8	1.0130			25.70	69
1 1/8-8	1.0162	1 1/64		25.80	67
1 1/8-8	1.0195			25.90	65
1 1/8-8	1.0227			26.00	63
1 1/8-8	1.0276			26.10	60
1 1/4-8	1.1185			28.40	81
1 1/4-8	1.1217			28.50	79
1 1/4-8	1.1250	1 1/8		28.570	77
1 1/4-8	1.1298			28.70	74
1 1/4-8	1.1315			28.75	73
1 1/4-8	1.1331			28.80	72
1 1/4-8	1.1380			28.90	69
1 1/4-8	1.1412			29.00	67
1 1/4-8	1.1461			29.10	64
1 1/4-8	1.1493			29.20	62
1 1/4-8	1.1542			29.30	59
1 3/8-8	1.2451			31.60	80
1 3/8-8	1.2483			31.70	78
1 3/8-8	1.2500	1 1/4		31.75	77
1 3/8-8	1.2516			31.80	76
1 3/8-8	1.2548			31.90	74
1 3/8-8	1.2581			32.00	72
1 3/8-8	1.2630			32.10	69
1 3/8-8	1.2662	1 17/64		32.15	67
1 3/8-8	1.2678			32.20	66
1 3/8-8	1.2695			32.25	65
1 3/8-8	1.2711			32.30	64
1 3/8-8	1.2760			32.40	61
1 3/8-8	1.2792			32.50	59
1 1/2-8	1.3701			34.80	80
1 1/2-8	1.3733			34.90	78
1 1/2-8	1.3750	1 3/8		34.92	77
1 1/2-8	1.3766			35.00	76
1 1/2-8	1.3815			35.10	73
1 1/2-8	1.3863			35.20	70
1 1/2-8	1.3896			35.30	68
1 1/2-8	1.3928			35.40	66
1 1/2-8	1.3977			35.50	63
1 1/2-8	1.4026			35.60	60

81-59% Theoretical Percentage of Thread					
Tap Size	dec	Fract	Wire/Let	mm	Theor %
1 5/8-8	1.4951			38.00	80
1 5/8-8	1.5000	1 1/2		38.10	77
1 5/8-8	1.5032			38.20	75
1 5/8-8	1.5081			38.30	72
1 5/8-8	1.5130			38.40	69
1 5/8-8	1.5162			38.50	67
1 5/8-8	1.5195			38.60	65
1 5/8-8	1.5243			38.70	62
1 5/8-8	1.5276			38.80	60
1 3/4-8	1.6217			41.20	79
1 3/4-8	1.6266			41.30	76
1 3/4-8	1.6298			41.40	74
1 3/4-8	1.6331			41.50	72
1 3/4-8	1.6380			41.60	69
1 3/4-8	1.6412			41.70	67
1 3/4-8	1.6461			41.80	64
1 3/4-8	1.6493			41.90	62
1 3/4-8	1.6526			42.00	60
2-8	1.8701			47.50	80
2-8	1.8733			47.60	78
2-8	1.8782			47.70	75
2-8	1.8815			47.80	73
2-8	1.8863			47.90	70
2-8	1.8896			48.00	68
2-8	1.8928			48.10	66
2-8	1.8977			48.20	63
2-8	1.9026			48.30	60
2 1/4-8	2.1217			53.90	79
2 1/4-8	2.1266			54.00	76
2 1/4-8	2.1298			54.10	74
2 1/4-8	2.1331			54.20	72
2 1/4-8	2.1380			54.30	69
2 1/4-8	2.1412			54.40	67
2 1/4-8	2.1461			54.50	64
2 1/4-8	2.1493			54.60	62
2 1/4-8	2.1542			54.70	59



Technical Information

Metric Tap Drill Sizes

81-59% Theoretical Percentage of Thread					
Tap Size	dec	Fract	Wire/Let	mm	Theor %
M3 x 0.35	0.1035			2.630	81
M3 x 0.35	0.1039		37	2.640	79
M3 x 0.35	0.1043			2.650	77
M3 x 0.35	0.1047			2.660	75
M3 x 0.35	0.1051			2.670	73
M3 x 0.35	0.1055			2.680	70
M3 x 0.35	0.1059			2.690	68
M3 x 0.35	0.1063			2.700	66
M3 x 0.35	0.1067		36	2.710	64
M3 x 0.35	0.1071			2.720	62
M3 x 0.35	0.1075			2.730	59
M3 x 0.50	0.0976			2.480	80
M3 x 0.50	0.0980		40	2.490	79
M3 x 0.50	0.0984			2.500	77
M3 x 0.50	0.0988			2.510	75
M3 x 0.50	0.0992			2.520	74
M3 x 0.50	0.0996		39	2.530	72
M3 x 0.50	0.1000			2.540	71
M3 x 0.50	0.1004			2.550	69
M3 x 0.50	0.1008			2.560	68
M3 x 0.50	0.1012			2.570	66
M3 x 0.50	0.1016		38	2.580	65
M3 x 0.50	0.1020			2.590	63
M3 x 0.50	0.1024			2.600	62
M3 x 0.50	0.1028			2.610	60
M3 x 0.50	0.1031			2.620	59
M3.5 x 0.60	0.1130		33	2.870	81
M3.5 x 0.60	0.1134			2.880	80
M3.5 x 0.60	0.1138			2.890	78
M3.5 x 0.60	0.1142			2.900	77
M3.5 x 0.60	0.1146			2.910	76
M3.5 x 0.60	0.1150			2.920	74
M3.5 x 0.60	0.1154			2.930	73
M3.5 x 0.60	0.1157			2.940	72
M3.5 x 0.60	0.1161		32	2.950	71
M3.5 x 0.60	0.1165			2.960	69
M3.5 x 0.60	0.1169			2.970	68
M3.5 x 0.60	0.1173			2.980	67
M3.5 x 0.60	0.1177			2.990	65
M3.5 x 0.60	0.1181			3.000	64
M3.5 x 0.60	0.1185			3.010	63
M3.5 x 0.60	0.1189			3.020	62
M3.5 x 0.60	0.1193			3.030	60
M3.5 x 0.60	0.1197			3.040	59
M4 x 0.50	0.1370			3.480	80
M4 x 0.50	0.1374			3.490	79
M4 x 0.50	0.1378			3.500	77
M4 x 0.50	0.1382			3.510	75
M4 x 0.50	0.1386			3.520	74
M4 x 0.50	0.1390			3.530	72
M4 x 0.50	0.1394			3.540	71
M4 x 0.50	0.1398			3.550	69
M4 x 0.50	0.1402			3.560	68
M4 x 0.50	0.1406	9/64	28	3.570	66
M4 x 0.50	0.1409			3.580	65
M4 x 0.50	0.1413			3.590	63
M4 x 0.50	0.1417			3.600	62
M4 x 0.50	0.1421			3.610	60
M4 x 0.50	0.1425			3.620	59
M4 x 0.70	0.1283		30	3.260	81
M4 x 0.70	0.1287			3.270	80
M4 x 0.70	0.1291			3.280	79
M4 x 0.70	0.1295			3.290	78
M4 x 0.70	0.1299			3.300	77
M4 x 0.70	0.1303			3.310	76
M4 x 0.70	0.1307			3.320	75
M4 x 0.70	0.1311			3.330	74
M4 x 0.70	0.1315			3.340	73
M4 x 0.70	0.1319			3.350	71
M4 x 0.70	0.1323			3.360	70
M4 x 0.70	0.1327			3.370	69
M4 x 0.70	0.1331			3.380	68
M4 x 0.70	0.1335			3.390	67
M4 x 0.70	0.1339			3.400	66
M4 x 0.70	0.1343			3.410	65
M4 x 0.70	0.1346			3.420	64
M4 x 0.70	0.1350			3.430	63
M4 x 0.70	0.1354			3.440	62
M4 x 0.70	0.1358		29	3.450	60
M4 x 0.70	0.1362			3.460	59
M5 x 0.50	0.1764			4.480	80

81-59% Theoretical Percentage of Thread					
Tap Size	dec	Fract	Wire/Let	mm	Theor %
M5 x 0.50	0.1768			4.490	79
M5 x 0.50	0.1772		16	4.500	77
M5 x 0.50	0.1776			4.510	75
M5 x 0.50	0.1780			4.520	74
M5 x 0.50	0.1783			4.530	72
M5 x 0.50	0.1787			4.540	71
M5 x 0.50	0.1791			4.550	69
M5 x 0.50	0.1795			4.560	68
M5 x 0.50	0.1799		15	4.570	66
M5 x 0.50	0.1803			4.580	65
M5 x 0.50	0.1807			4.590	63
M5 x 0.50	0.1811			4.600	62
M5 x 0.50	0.1815			4.610	60
M5 x 0.50	0.1819		14	4.620	59
M5 x 0.80	0.1638			4.160	81
M5 x 0.80	0.1642			4.170	80
M5 x 0.80	0.1646			4.180	79
M5 x 0.80	0.1650			4.190	78
M5 x 0.80	0.1654			4.200	77
M5 x 0.80	0.1657			4.210	76
M5 x 0.80	0.1661		19	4.220	75
M5 x 0.80	0.1665			4.230	74
M5 x 0.80	0.1669			4.240	73
M5 x 0.80	0.1673			4.250	72
M5 x 0.80	0.1677			4.260	71
M5 x 0.80	0.1681			4.270	70
M5 x 0.80	0.1685			4.280	69
M5 x 0.80	0.1689			4.290	68
M5 x 0.80	0.1693		18	4.300	67
M5 x 0.80	0.1697			4.310	66
M5 x 0.80	0.1701			4.320	65
M5 x 0.80	0.1705			4.330	64
M5 x 0.80	0.1709			4.340	64
M5 x 0.80	0.1713			4.350	63
M5 x 0.80	0.1717			4.360	62
M5 x 0.80	0.1720	11/64		4.370	61
M5 x 0.80	0.1724			4.380	60
M5 x 0.80	0.1728		17	4.390	59
M6 x 0.50	0.2165			5.500	77
M6 x 0.50	0.2185			5.550	69
M6 x 0.50	0.2189	7/32		5.560	68
M6 x 0.50	0.2205			5.600	62
M6 x 0.50	0.2209		2	5.610	60
M6 x 0.75	0.2055		5	5.220	80
M6 x 0.75	0.2067			5.250	77
M6 x 0.75	0.2087			5.300	72
M6 x 0.75	0.2091		4	5.310	71
M6 x 0.75	0.2106			5.350	67
M6 x 0.75	0.2126			5.400	62
M6 x 0.75	0.2130		3	5.410	61
M6 x 1.00	0.1949			4.950	81
M6 x 1.00	0.1953			4.960	80
M6 x 1.00	0.1957			4.970	79
M6 x 1.00	0.1961		9	4.980	79
M6 x 1.00	0.1965			4.990	78
M6 x 1.00	0.1969			5.000	77
M6 x 1.00	0.1988			5.050	73
M6 x 1.00	0.1992		8	5.060	72
M6 x 1.00	0.2008			5.100	69
M6 x 1.00	0.2012		7	5.110	69
M6 x 1.00	0.2028			5.150	65
M6 x 1.00	0.2031	13/64		5.160	65
M6 x 1.00	0.2039		6	5.180	63
M6 x 1.00	0.2047			5.200	62
M6 x 1.00	0.2055		5	5.220	60
M7 x 0.75	0.2461		D	6.250	77
M7 x 0.75	0.2480			6.300	72
M7 x 0.75	0.2500	1/4	E	6.350	67
M7 x 0.75	0.2520			6.400	62
M7 x 1.00	0.2343	15/64		5.950	81
M7 x 1.00	0.2362			6.000	77
M7 x 1.00	0.2378		B	6.040	74
M7 x 1.00	0.2382			6.050	73
M7 x 1.00	0.2402			6.100	69
M7 x 1.00	0.2421		C	6.150	65
M7 x 1.00	0.2441			6.200	62
M8 x 0.50	0.2949		M	7.490	79
M8 x 0.50	0.2953			7.500	77
M8 x 0.50	0.2969	19/64		7.540	71
M8 x 0.50	0.2972			7.550	69
M8 x 0.50	0.2992			7.600	62

Technical Information

Metric Tap Drill Sizes

81-59% Theoretical Percentage of Thread					
Tap Size	dec	Fract	Wire/Let	mm	Theor %
M8 x 0.75	0.2854			7.250	77
M8 x 0.75	0.2874			7.300	72
M8 x 0.75	0.2894			7.350	67
M8 x 0.75	0.2902		L	7.370	65
M8 x 0.75	0.2913			7.400	62
M8 x 1.00	0.2736			6.950	81
M8 x 1.00	0.2756			7.000	77
M8 x 1.00	0.2768		J	7.030	75
M8 x 1.00	0.2776			7.050	73
M8 x 1.00	0.2795			7.100	69
M8 x 1.00	0.2811	9/32	K	7.140	66
M8 x 1.00	0.2815			7.150	65
M8 x 1.00	0.2835			7.200	62
M8 x 1.25	0.2638			6.700	80
M8 x 1.25	0.2657	17/64	H	6.750	77
M8 x 1.25	0.2677			6.800	74
M8 x 1.25	0.2697			6.850	71
M8 x 1.25	0.2717		I	6.900	68
M8 x 1.25	0.2736			6.950	65
M8 x 1.25	0.2756			7.000	62
M8 x 1.25	0.2768		J	7.030	60
M8 x 1.25	0.2776			7.050	59
M9 x 1.00	0.3130			7.950	81
M9 x 1.00	0.3150			8.000	77
M9 x 1.00	0.3161		O	8.030	75
M9 x 1.00	0.3169			8.050	73
M9 x 1.00	0.3189			8.100	69
M9 x 1.00	0.3209			8.150	65
M9 x 1.00	0.3228		P	8.200	62
M10 x 0.75	0.3642			9.250	77
M10 x 0.75	0.3661			9.300	72
M10 x 0.75	0.3677		U	9.340	68
M10 x 0.75	0.3681			9.350	67
M10 x 0.75	0.3701			9.400	62
M10 x 1.00	0.3524			8.950	81
M10 x 1.00	0.3543			9.000	77
M10 x 1.00	0.3563			9.050	73
M10 x 1.00	0.3579		T	9.090	70
M10 x 1.00	0.3583			9.100	69
M10 x 1.00	0.3594	23/64		9.130	67
M10 x 1.00	0.3602			9.150	65
M10 x 1.00	0.3622			9.200	62
M10 x 1.25	0.3425			8.700	80
M10 x 1.25	0.3437	11/32		8.730	78
M10 x 1.25	0.3445			8.750	77
M10 x 1.25	0.3465			8.800	74
M10 x 1.25	0.3480		S	8.840	71
M10 x 1.25	0.3484			8.850	71
M10 x 1.25	0.3504			8.900	68
M10 x 1.25	0.3524			8.950	65
M10 x 1.25	0.3543			9.000	62
M10 x 1.25	0.3563			9.050	59
M10 x 1.50	0.3319		Q	8.430	81
M10 x 1.50	0.3327			8.450	80
M10 x 1.50	0.3346			8.500	77
M10 x 1.50	0.3366			8.550	74
M10 x 1.50	0.3386			8.600	72
M10 x 1.50	0.3390		R	8.610	71
M10 x 1.50	0.3406			8.650	69
M10 x 1.50	0.3425			8.700	67
M10 x 1.50	0.3437	11/32		8.730	65
M10 x 1.50	0.3445			8.750	64
M10 x 1.50	0.3465			8.800	62
M10 x 1.50	0.3480		S	8.840	60
M10 x 1.50	0.3484			8.850	59
M11 x 1.00	0.3917			9.950	81
M11 x 1.00	0.3937			10.000	77
M11 x 1.00	0.3957			10.050	73
M11 x 1.00	0.3969		X	10.080	71
M11 x 1.00	0.3976			10.100	69
M11 x 1.00	0.3996			10.150	65
M11 x 1.00	0.4016			10.200	62
M12 x 1.00	0.4311			10.950	81
M12 x 1.00	0.4331			11.000	77
M12 x 1.00	0.4350			11.050	73
M12 x 1.00	0.4370			11.100	69
M12 x 1.00	0.4374	7/16		11.110	69
M12 x 1.00	0.4390			11.150	65
M12 x 1.00	0.4409			11.200	62
M12 x 1.25	0.4213			10.700	80
M12 x 1.25	0.4220	27/64		10.720	79

81-59% Theoretical Percentage of Thread					
Tap Size	dec	Fract	Wire/Let	mm	Theor %
M12 x 1.25	0.4232			10.750	77
M12 x 1.25	0.4252			10.800	74
M12 x 1.25	0.4272			10.850	71
M12 x 1.25	0.4291			10.900	68
M12 x 1.25	0.4311			10.950	65
M12 x 1.25	0.4331			11.000	62
M12 x 1.25	0.4350			11.050	59
M12 x 1.50	0.4114			10.450	80
M12 x 1.50	0.4130		Z	10.490	77
M12 x 1.50	0.4134			10.500	77
M12 x 1.50	0.4154			10.550	74
M12 x 1.50	0.4173			10.600	72
M12 x 1.50	0.4193			10.650	69
M12 x 1.50	0.4213			10.700	67
M12 x 1.50	0.4220	27/64		10.720	66
M12 x 1.50	0.4232			10.750	64
M12 x 1.50	0.4252			10.800	62
M12 x 1.50	0.4272			10.850	59
M12 x 1.75	0.3996			10.150	81
M12 x 1.75	0.4016			10.200	79
M12 x 1.75	0.4035			10.250	77
M12 x 1.75	0.4039		Y	10.260	77
M12 x 1.75	0.4055			10.300	75
M12 x 1.75	0.4063	13/32		10.320	74
M12 x 1.75	0.4075			10.350	73
M12 x 1.75	0.4094			10.400	70
M12 x 1.75	0.4114			10.450	68
M12 x 1.75	0.4130		Z	10.490	66
M12 x 1.75	0.4134			10.500	66
M12 x 1.75	0.4154			10.550	64
M12 x 1.75	0.4173			10.600	62
M12 x 1.75	0.4193			10.650	59
M14 x 1.00	0.5098			12.950	81
M14 x 1.00	0.5118			13.000	77
M14 x 1.00	0.5138			13.050	73
M14 x 1.00	0.5157	33/64		13.100	69
M14 x 1.00	0.5177			13.150	65
M14 x 1.00	0.5197			13.200	62
M14 x 1.25	0.5000	1/2		12.700	80
M14 x 1.25	0.5020			12.750	77
M14 x 1.25	0.5039			12.800	74
M14 x 1.25	0.5059			12.850	71
M14 x 1.25	0.5079			12.900	68
M14 x 1.25	0.5098			12.950	65
M14 x 1.25	0.5118			13.000	62
M14 x 1.25	0.5138			13.050	59
M14 x 1.50	0.4902			12.450	80
M14 x 1.50	0.4921			12.500	77
M14 x 1.50	0.4941			12.550	74
M14 x 1.50	0.4961			12.600	72
M14 x 1.50	0.4980			12.650	69
M14 x 1.50	0.5000	1/2		12.700	67
M14 x 1.50	0.5020			12.750	64
M14 x 1.50	0.5039			12.800	62
M14 x 1.50	0.5059			12.850	59
M14 x 2.00	0.4685			11.900	81
M14 x 2.00	0.4689	15/32		11.910	80
M14 x 2.00	0.4705			11.950	79
M14 x 2.00	0.4724			12.000	77
M14 x 2.00	0.4744			12.050	75
M14 x 2.00	0.4764			12.100	73
M14 x 2.00	0.4783			12.150	71
M14 x 2.00	0.4803			12.200	69
M14 x 2.00	0.4823			12.250	67
M14 x 2.00	0.4843	31/64		12.300	65
M14 x 2.00	0.4862			12.350	64
M14 x 2.00	0.4882			12.400	62
M14 x 2.00	0.4902			12.450	60
M15 x 1.00	0.5492			13.950	81
M15 x 1.00	0.5512			14.000	77
M15 x 1.00	0.5531			14.050	73
M15 x 1.00	0.5551			14.100	69
M15 x 1.00	0.5571			14.150	65
M15 x 1.00	0.5591			14.200	62
M15 x 1.50	0.5295			13.450	80
M15 x 1.50	0.5311	17/32		13.490	77
M15 x 1.50	0.5315			13.500	77
M15 x 1.50	0.5335			13.550	74
M15 x 1.50	0.5354			13.600	72
M15 x 1.50	0.5374			13.650	69
M15 x 1.50	0.5394			13.700	67

Technical Information

Metric Tap Drill Sizes

81-59% Theoretical Percentage of Thread					
Tap Size	dec	Fract	Wire/Let	mm	Theor %
M15 x 1.50	0.5413			13.750	64
M15 x 1.50	0.5433			13.800	62
M15 x 1.50	0.5453			13.850	59
M16 x 1.00	0.5886			14.950	81
M16 x 1.00	0.5906			15.000	77
M16 x 1.00	0.5925			15.050	73
M16 x 1.00	0.5937	19/32		15.080	71
M16 x 1.00	0.5945			15.100	69
M16 x 1.00	0.5965			15.150	65
M16 x 1.00	0.5984			15.200	62
M16 x 1.50	0.5689			14.450	80
M16 x 1.50	0.5709			14.500	77
M16 x 1.50	0.5728			14.550	74
M16 x 1.50	0.5748			14.600	72
M16 x 1.50	0.5768			14.650	69
M16 x 1.50	0.5787			14.700	67
M16 x 1.50	0.5807			14.750	64
M16 x 1.50	0.5827			14.800	62
M16 x 1.50	0.5846			14.850	59
M16 x 2.00	0.5469	35/64		13.890	81
M16 x 2.00	0.5472			13.900	81
M16 x 2.00	0.5492			13.950	79
M16 x 2.00	0.5512			14.000	77
M16 x 2.00	0.5531			14.050	75
M16 x 2.00	0.5551			14.100	73
M16 x 2.00	0.5571			14.150	71
M16 x 2.00	0.5591			14.200	69
M16 x 2.00	0.5610			14.250	67
M16 x 2.00	0.5626	9/16		14.290	66
M16 x 2.00	0.5630			14.300	65
M16 x 2.00	0.5650			14.350	64
M16 x 2.00	0.5669			14.400	62
M16 x 2.00	0.5689			14.450	60
M18 x 1.00	0.6673			16.950	81
M18 x 1.00	0.6693			17.000	77
M18 x 1.00	0.6713			17.050	73
M18 x 1.00	0.6720	43/64		17.070	72
M18 x 1.00	0.6732			17.100	69
M18 x 1.00	0.6752			17.150	65
M18 x 1.00	0.6772			17.200	62
M18 x 1.50	0.6476			16.450	80
M18 x 1.50	0.6496			16.500	77
M18 x 1.50	0.6516			16.550	74
M18 x 1.50	0.6535			16.600	72
M18 x 1.50	0.6555			16.650	69
M18 x 1.50	0.6563	21/32		16.670	68
M18 x 1.50	0.6575			16.700	67
M18 x 1.50	0.6594			16.750	64
M18 x 1.50	0.6614			16.800	62
M18 x 1.50	0.6634			16.850	59
M18 x 2.00	0.6260			15.900	81
M18 x 2.00	0.6280			15.950	79
M18 x 2.00	0.6299			16.000	77
M18 x 2.00	0.6319			16.050	75
M18 x 2.00	0.6339			16.100	73
M18 x 2.00	0.6358			16.150	71
M18 x 2.00	0.6378			16.200	69
M18 x 2.00	0.6398			16.250	67
M18 x 2.00	0.6406	41/64		16.270	67
M18 x 2.00	0.6417			16.300	65
M18 x 2.00	0.6437			16.350	64
M18 x 2.00	0.6457			16.400	62
M18 x 2.00	0.6476			16.450	60
M18 x 2.50	0.6063			15.400	80
M18 x 2.50	0.6083			15.450	79
M18 x 2.50	0.6094	39/64		15.480	78
M18 x 2.50	0.6102			15.500	77
M18 x 2.50	0.6122			15.550	75
M18 x 2.50	0.6142			15.600	74
M18 x 2.50	0.6161			15.650	72
M18 x 2.50	0.6181			15.700	71
M18 x 2.50	0.6201			15.750	69
M18 x 2.50	0.6220			15.800	68
M18 x 2.50	0.6240			15.850	66
M18 x 2.50	0.6248	5/8		15.870	66
M18 x 2.50	0.6260			15.900	65
M18 x 2.50	0.6280			15.950	63
M18 x 2.50	0.6299			16.000	62
M18 x 2.50	0.6319			16.050	60
M18 x 2.50	0.6339			16.100	59
M20 x 1.50	0.7264			18.450	80

81-59% Theoretical Percentage of Thread					
Tap Size	dec	Fract	Wire/Let	mm	Theor %
M20 x 1.50	0.7283			18.500	77
M20 x 1.50	0.7303			18.550	74
M20 x 1.50	0.7323			18.600	72
M20 x 1.50	0.7343	47/64		18.650	69
M20 x 1.50	0.7362			18.700	67
M20 x 1.50	0.7382			18.750	64
M20 x 1.50	0.7402			18.800	62
M20 x 1.50	0.7421			18.850	59
M20 x 2.00	0.7047			17.900	81
M20 x 2.00	0.7067			17.950	79
M20 x 2.00	0.7087			18.000	77
M20 x 2.00	0.7106			18.050	75
M20 x 2.00	0.7126			18.100	73
M20 x 2.00	0.7146			18.150	71
M20 x 2.00	0.7165			18.200	69
M20 x 2.00	0.7185			18.250	67
M20 x 2.00	0.7189	23/32		18.260	67
M20 x 2.00	0.7205			18.300	65
M20 x 2.00	0.7224			18.350	64
M20 x 2.00	0.7244			18.400	62
M20 x 2.00	0.7264			18.450	60
M20 x 2.50	0.6850			17.400	80
M20 x 2.50	0.6870			17.450	79
M20 x 2.50	0.6874	11/16		17.460	78
M20 x 2.50	0.6890			17.500	77
M20 x 2.50	0.6909			17.550	75
M20 x 2.50	0.6929			17.600	74
M20 x 2.50	0.6949			17.650	72
M20 x 2.50	0.6969			17.700	71
M20 x 2.50	0.6988			17.750	69
M20 x 2.50	0.7008			17.800	68
M20 x 2.50	0.7028			17.850	66
M20 x 2.50	0.7031	45/64		17.860	66
M20 x 2.50	0.7047			17.900	65
M20 x 2.50	0.7067			17.950	63
M20 x 2.50	0.7087			18.000	62
M20 x 2.50	0.7106			18.050	60
M20 x 2.50	0.7126			18.100	59
M22 x 1.00	0.8248			20.950	81
M22 x 1.00	0.8268			21.000	77
M22 x 1.00	0.8280	53/64		21.030	75
M22 x 1.00	0.8287			21.050	73
M22 x 1.00	0.8307			21.100	69
M22 x 1.00	0.8327			21.150	65
M22 x 1.00	0.8346			21.200	62
M22 x 1.50	0.8051			20.450	80
M22 x 1.50	0.8071			20.500	77
M22 x 1.50	0.8091			20.550	74
M22 x 1.50	0.8110			20.600	72
M22 x 1.50	0.8126	13/16		20.640	70
M22 x 1.50	0.8130			20.650	69
M22 x 1.50	0.8150			20.700	67
M22 x 1.50	0.8169			20.750	64
M22 x 1.50	0.8189			20.800	62
M22 x 1.50	0.8209			20.850	59
M22 x 2.00	0.7835			19.900	81
M22 x 2.00	0.7854			19.950	79
M22 x 2.00	0.7874			20.000	77
M22 x 2.00	0.7894			20.050	75
M22 x 2.00	0.7913			20.100	73
M22 x 2.00	0.7933			20.150	71
M22 x 2.00	0.7953			20.200	69
M22 x 2.00	0.7969	51/64		20.240	68
M22 x 2.00	0.7972			20.250	67
M22 x 2.00	0.7992			20.300	65
M22 x 2.00	0.8012			20.350	64
M22 x 2.00	0.8031			20.400	62
M22 x 2.00	0.8051			20.450	60
M22 x 2.50	0.7638			19.400	80
M22 x 2.50	0.7657	49/64		19.450	79
M22 x 2.50	0.7677			19.500	77
M22 x 2.50	0.7697			19.550	75
M22 x 2.50	0.7717			19.600	74
M22 x 2.50	0.7736			19.650	72
M22 x 2.50	0.7756			19.700	71
M22 x 2.50	0.7776			19.750	69
M22 x 2.50	0.7795			19.800	68
M22 x 2.50	0.7811	25/32		19.840	67
M22 x 2.50	0.7815			19.850	66
M22 x 2.50	0.7835			19.900	65
M22 x 2.50	0.7854			19.950	63

Technical Information

Metric Tap Drill Sizes

81-59% Theoretical Percentage of Thread					
Tap Size	dec	Fract	Wire/Let	mm	Theor %
M22 x 2.50	0.7874			20.000	62
M22 x 2.50	0.7894			20.050	60
M22 x 2.50	0.7913			20.100	59
M24 x 1.00	0.9035			22.950	81
M24 x 1.00	0.9055			23.000	77
M24 x 1.00	0.9063	29/32		23.020	75
M24 x 1.00	0.9075			23.050	73
M24 x 1.00	0.9094			23.100	69
M24 x 1.00	0.9114			23.150	65
M24 x 1.00	0.9134			23.200	62
M24 x 1.50	0.8839			22.450	80
M24 x 1.50	0.8858			22.500	77
M24 x 1.50	0.8878			22.550	74
M24 x 1.50	0.8898			22.600	72
M24 x 1.50	0.8917			22.650	69
M24 x 1.50	0.8937			22.700	67
M24 x 1.50	0.8957			22.750	64
M24 x 1.50	0.8976			22.800	62
M24 x 1.50	0.8996			22.850	59
M24 x 2.00	0.8622			21.900	81
M24 x 2.00	0.8642			21.950	79
M24 x 2.00	0.8661			22.000	77
M24 x 2.00	0.8681			22.050	75
M24 x 2.00	0.8701			22.100	73
M24 x 2.00	0.8720			22.150	71
M24 x 2.00	0.8740			22.200	69
M24 x 2.00	0.8748	7/8		22.220	69
M24 x 2.00	0.8760			22.250	67
M24 x 2.00	0.8780			22.300	65
M24 x 2.00	0.8799			22.350	64
M24 x 2.00	0.8819			22.400	62
M24 x 2.00	0.8839			22.450	60
M24 x 3.00	0.8209			20.850	81
M24 x 3.00	0.8228			20.900	80
M24 x 3.00	0.8248			20.950	78
M24 x 3.00	0.8268			21.000	77
M24 x 3.00	0.8280	53/64		21.030	76
M24 x 3.00	0.8287			21.050	76
M24 x 3.00	0.8307			21.100	74
M24 x 3.00	0.8327			21.150	73
M24 x 3.00	0.8346			21.200	72
M24 x 3.00	0.8366			21.250	71
M24 x 3.00	0.8386			21.300	69
M24 x 3.00	0.8406			21.350	68
M24 x 3.00	0.8425			21.400	67
M24 x 3.00	0.8437	27/32		21.430	66
M24 x 3.00	0.8445			21.450	65
M24 x 3.00	0.8465			21.500	64
M24 x 3.00	0.8484			21.550	63
M24 x 3.00	0.8504			21.600	62
M24 x 3.00	0.8524			21.650	60
M24 x 3.00	0.8543			21.700	59
M27 x 3.00	0.9370			23.800	82
M27 x 3.00	0.9374	15/16		23.810	82
M27 x 3.00	0.9409			23.900	80
M27 x 3.00	0.9449			24.000	77
M27 x 3.00	0.9488			24.100	74
M27 x 3.00	0.9528			24.200	72
M27 x 3.00	0.9531	61/64		24.210	72
M27 x 3.00	0.9567			24.300	69
M27 x 3.00	0.9606			24.400	67
M27 x 3.00	0.9646			24.500	64
M27 x 3.00	0.9685			24.600	62
M27 x 3.00	0.9689	31/32		24.610	61
M27 x 3.00	0.9724			24.700	59
M27 x 2.00	0.9803			24.900	81
M27 x 2.00	0.9843	63/64		25.000	77
M27 x 2.00	0.9882			25.100	73
M27 x 2.00	0.9921			25.200	69
M27 x 2.00	0.9961			25.300	65
M27 x 2.00	1.0000	1		25.400	62

81-59% Theoretical Percentage of Thread					
Tap Size	dec	Fract	Wire/Let	mm	Theor %
M30 x 3.50	1.0354			26.300	83
M30 x 3.50	1.0394			26.400	79
M30 x 3.50	1.0433			26.500	77
M30 x 3.50	1.0469	1 3/64		26.590	75
M30 x 3.50	1.0472			26.600	75
M30 x 3.50	1.0512			26.700	73
M30 x 3.50	1.0551			26.800	70
M30 x 3.50	1.0591			26.900	68
M30 x 3.50	1.0626	1 1/16		26.990	66
M30 x 3.50	1.0630			27.000	66
M30 x 3.50	1.0669			27.100	64
M30 x 3.50	1.0709			27.200	62
M30 x 3.50	1.0748			27.300	59
M30 x 2.00	1.0984			27.900	81
M30 x 2.00	1.1024			28.000	77
M30 x 2.00	1.1063			28.100	73
M30 x 2.00	1.1094	1 7/64		28.180	70
M30 x 2.00	1.1102			28.200	69
M30 x 2.00	1.1142			28.300	65
M30 x 2.00	1.1181			28.400	62
M30 x 2.00	1.1220			28.500	58
M33 x 3.50	1.1535			29.300	81
M33 x 3.50	1.1563	1 5/32		29.370	80
M33 x 3.50	1.1575			29.400	79
M33 x 3.50	1.1614			29.500	77
M33 x 3.50	1.1654			29.600	75
M33 x 3.50	1.1693	1 11/64		29.770	71
M33 x 3.50	1.1732			29.800	70
M33 x 3.50	1.1772			29.900	68
M33 x 3.50	1.1811			30.000	66
M33 x 3.50	1.1850			30.100	64
M33 x 3.50	1.1874	1 3/16		30.160	62
M33 x 3.50	1.1890			30.200	62
M33 x 3.50	1.1929			30.300	59
M33 x 2.00	1.2165			30.900	81
M33 x 2.00	1.2189	1 7/32		30.960	79
M33 x 2.00	1.2205			31.000	77
M33 x 2.00	1.2244			31.100	73
M33 x 2.00	1.2283			31.200	69
M33 x 2.00	1.2323			31.300	65
M33 x 2.00	1.2343	1 15/64		31.350	64
M33 x 2.00	1.2362			31.400	62
M33 x 2.00	1.2402			31.500	58
M36 x 4.00	1.2500	1 1/4		31.750	82
M36 x 4.00	1.2520			31.800	81
M36 x 4.00	1.2559			31.900	79
M36 x 4.00	1.2598			32.000	77
M36 x 4.00	1.2638			32.100	75
M36 x 4.00	1.2657	1 17/64		32.150	74
M36 x 4.00	1.2677			32.200	73
M36 x 4.00	1.2717			32.300	71
M36 x 4.00	1.2756			32.400	69
M36 x 4.00	1.2795			32.500	67
M36 x 4.00	1.2811	1 9/32		32.540	67
M36 x 4.00	1.2835			32.600	65
M36 x 4.00	1.2874			32.700	64
M36 x 4.00	1.2913			32.800	62
M36 x 4.00	1.2953			32.900	60
M36 x 4.00	1.2969	1 19/64		32.940	59
M36 x 3.00	1.2913			32.800	82
M36 x 3.00	1.2953			32.900	80
M36 x 3.00	1.2969	1 19/64		32.940	79
M36 x 3.00	1.2992			33.000	77
M36 x 3.00	1.3031			33.100	74
M36 x 3.00	1.3071			33.200	72
M36 x 3.00	1.3110			33.300	69
M36 x 3.00	1.3126	1 5/16		33.340	68
M36 x 3.00	1.3150			33.400	67
M36 x 3.00	1.3189			33.500	64
M36 x 3.00	1.3228			33.600	62
M36 x 3.00	1.3268			33.700	59

Technical Information

DRILL SIZE FOR THREAD FORMING @ 55% THREAD								
Metric Threads			Metric Threads			UNC / UNF Threads		
Tap Dia.	Pitch mm	Drill size mm	Tap Dia.	Pitch mm	Drill size mm	Tap Size	TPI	Drill size mm
M 1	0.25	0.91	M 10	0.75	9.72	2	56	2.01
M 1.1	0.25	1.01	M 10	1.00	9.63	2	64	2.04
M 1.2	0.25	1.11	M 10	1.25	9.53	3	48	2.32
M 1.4	0.30	1.29	M 10	1.50	9.44	3	56	2.34
M 1.6	0.35	1.47	M 11	0.75	10.72	4	40	2.61
M 1.7	0.35	1.57	M 11	1.00	10.63	4	48	2.65
M 1.8	0.35	1.67	M 11	1.50	10.44	5	40	2.94
M 2	0.40	1.85	M 12	1.00	11.63	5	44	2.96
M 2.2	0.45	2.03	M 12	1.25	11.53	6	32	3.21
M 2.3	0.40	2.15	M 12	1.50	11.44	6	40	3.27
M 2.5	0.45	2.33	M 12	1.75	11.35	8	32	3.87
M 2.6	0.45	2.43	M 14	1.00	13.63	8	36	3.90
M 3	0.50	2.81	M 14	1.25	13.53	10	24	4.43
M 3.5	0.60	3.28	M 14	1.50	13.44	10	32	4.53
M 4	0.70	3.74	M 14	2.00	13.25	12	24	5.09
M 4.5	0.75	4.22	M 15	1.00	14.63	12	28	5.15
M 5	0.50	4.81	M 15	1.50	14.44	1/4	20	5.88
M 5	0.80	4.70	M 16	1.00	15.63	1/4	28	6.01
M 5.5	0.50	5.31	M 16	1.50	15.44	5/16	18	7.41
M 6	0.75	5.72	M 16	2.00	15.25	5/16	24	7.54
M 6	1.00	5.63	M 17	1.00	16.63	3/8	16	8.93
M 7	0.75	6.72	M 17	1.50	16.44	3/8	24	9.13
M 7	1.00	6.63	M 18	1.00	17.63	7/16	14	10.43
M 8	0.75	7.72	M 18	1.50	17.44	7/16	20	10.64
M 8	1.00	7.63	M 18	2.00	17.25	1/2	13	11.97
M 8	1.25	7.53	M 18	2.50	17.07	1/2	20	12.23
M 9	0.75	8.72	M 20	1.00	19.63	9/16	12	13.50
M 9	1.00	8.63	M 20	2.50	19.07	9/16	18	13.76
M 9	1.25	8.53				5/8	11	15.01
						5/8	18	15.35
						3/4	10	18.10
						3/4	16	18.46
						7/8	9	21.17
						7/8	14	21.55
						1	8	24.21
						1	12	24.61

DRILL SIZE FOR THREAD FORMING @ 57.5% THREAD								
Metric Threads			Metric Threads			UNC / UNF Threads		
Tap Dia.	Pitch mm	Drill size mm	Tap Dia.	Pitch mm	Drill size mm	Tap Size	TPI	Drill size mm
M 1	0.25	0.90	M 10	0.75	9.71	2	56	2.01
M 1.1	0.25	1.00	M 10	1.00	9.61	2	64	2.03
M 1.2	0.25	1.10	M 10	1.25	9.51	3	48	2.31
M 1.4	0.30	1.28	M 10	1.50	9.41	3	56	2.34
M 1.6	0.35	1.46	M 11	0.75	10.71	4	40	2.60
M 1.7	0.35	1.56	M 11	1.00	10.61	4	48	2.64
M 1.8	0.35	1.66	M 11	1.50	10.41	5	40	2.93
M 2	0.40	1.84	M 12	1.00	11.61	5	44	2.95
M 2.2	0.45	2.02	M 12	1.25	11.51	6	32	3.19
M 2.3	0.40	2.14	M 12	1.50	11.41	6	40	3.26
M 2.5	0.45	2.32	M 12	1.75	11.32	8	32	3.86
M 2.6	0.45	2.42	M 14	1.00	13.61	8	36	3.89
M 3	0.50	2.80	M 14	1.25	13.51	10	24	4.41
M 3.5	0.60	3.27	M 14	1.50	13.41	10	32	4.52
M 4	0.70	3.73	M 14	2.00	13.22	12	24	5.07
M 4.5	0.75	4.21	M 15	1.00	14.61	12	28	5.13
M 5	0.50	4.80	M 15	1.50	14.41	1/4	20	5.85
M 5	0.80	4.69	M 16	1.00	15.61	1/4	28	6.00
M 5.5	0.50	5.30	M 16	1.50	15.41	5/16	18	7.39
M 6	0.75	5.71	M 16	2.00	15.22	5/16	24	7.52
M 6	1.00	5.61	M 17	1.00	16.61	3/8	16	8.90
M 7	0.75	6.71	M 17	1.50	16.41	3/8	24	9.11
M 7	1.00	6.61	M 18	1.00	17.61	7/16	14	10.40
M 8	0.75	7.71	M 18	1.50	17.41	7/16	20	10.62
M 8	1.00	7.61	M 18	2.00	17.22	1/2	13	11.94
M 8	1.25	7.51	M 18	2.50	17.02	1/2	20	12.20
M 9	0.75	8.71	M 20	1.00	19.61	9/16	12	13.46
M 9	1.00	8.61	M 20	2.50	19.02	9/16	18	13.74
M 9	1.25	8.51				5/8	11	14.97
						5/8	18	15.32
						3/4	10	18.06
						3/4	16	18.43
						7/8	9	21.12
						7/8	14	21.52
						1	8	24.16
						1	12	24.57

DRILL SIZE FOR THREAD FORMING @ 60% THREAD								
Metric Threads			Metric Threads			UNC / UNF Threads		
Tap Dia.	Pitch mm	Drill size mm	Tap Dia.	Pitch mm	Drill size mm	Tap Size	TPI	Drill size mm
M 1	0.25	0.90	M 10	0.75	9.69	2	56	2.00
M 1.1	0.25	1.00	M 10	1.00	9.59	2	64	2.02
M 1.2	0.25	1.10	M 10	1.25	9.49	3	48	2.30
M 1.4	0.30	1.28	M 10	1.50	9.39	3	56	2.33
M 1.6	0.35	1.46	M 11	0.75	10.69	4	40	2.59
M 1.7	0.35	1.56	M 11	1.00	10.59	4	48	2.63
M 1.8	0.35	1.66	M 11	1.50	10.39	5	40	2.92
M 2	0.40	1.84	M 12	1.00	11.59	5	44	2.94
M 2.2	0.45	2.02	M 12	1.25	11.49	6	32	3.18
M 2.3	0.40	2.14	M 12	1.50	11.39	6	40	3.25
M 2.5	0.45	2.32	M 12	1.75	11.29	8	32	3.84
M 2.6	0.45	2.42	M 14	1.00	13.59	8	36	3.88
M 3	0.50	2.80	M 14	1.25	13.49	10	24	4.39
M 3.5	0.60	3.26	M 14	1.50	13.39	10	32	4.50
M 4	0.70	3.71	M 14	2.00	13.18	12	24	5.05
M 4.5	0.75	4.19	M 15	1.00	14.59	12	28	5.12
M 5	0.50	4.80	M 15	1.50	14.39	1/4	20	5.83
M 5	0.80	4.67	M 16	1.00	15.59	1/4	28	5.98
M 5.5	0.50	5.30	M 16	1.50	15.39	5/16	18	7.36
M 6	0.75	5.69	M 16	2.00	15.18	5/16	24	7.51
M 6	1.00	5.59	M 17	1.00	16.59	3/8	16	8.88
M 7	0.75	6.69	M 17	1.50	16.39	3/8	24	9.09
M 7	1.00	6.59	M 18	1.00	17.59	7/16	14	10.37
M 8	0.75	7.69	M 18	1.50	17.39	7/16	20	10.59
M 8	1.00	7.59	M 18	2.00	17.18	1/2	13	11.90
M 8	1.25	7.49	M 18	2.50	16.98	1/2	20	12.18
M 9	0.75	8.69	M 20	1.00	19.59	9/16	12	13.42
M 9	1.00	8.59	M 20	2.50	18.98	9/16	18	13.71
M 9	1.25	8.49				5/8	11	14.93
						5/8	18	15.30
						3/4	10	18.01
						3/4	16	18.40
						7/8	9	21.07
						7/8	14	21.48
						1	8	24.10
						1	12	24.54

DRILL SIZE FOR THREAD FORMING @ 62.5% THREAD								
Metric Threads			Metric Threads			UNC / UNF Threads		
Tap Dia.	Pitch mm	Drill size mm	Tap Dia.	Pitch mm	Drill size mm	Tap Size	TPI	Drill size mm
M 1	0.25	0.89	M 10	0.75	9.68	2	56	1.99
M 1.1	0.25	0.99	M 10	1.00	9.58	2	64	2.02
M 1.2	0.25	1.09	M 10	1.25	9.47	3	48	2.29
M 1.4	0.30	1.27	M 10	1.50	9.36	3	56	2.32
M 1.6	0.35	1.45	M 11	0.75	10.68	4	40	2.57
M 1.7	0.35	1.55	M 11	1.00	10.58	4	48	2.62
M 1.8	0.35	1.65	M 11	1.50	10.36	5	40	2.91
M 2	0.40	1.83	M 12	1.00	11.58	5	44	2.93
M 2.2	0.45	2.01	M 12	1.25	11.47	6	32	3.17
M 2.3	0.40	2.13	M 12	1.50	11.36	6	40	3.24
M 2.5	0.45	2.31	M 12	1.75	11.26	8	32	3.83
M 2.6	0.45	2.41	M 14	1.00	13.58	8	36	3.87
M 3	0.50	2.79	M 14	1.25	13.47	10	24	4.38
M 3.5	0.60	3.25	M 14	1.50	13.36	10	32	4.49
M 4	0.70	3.70	M 14	2.00	13.15	12	24	5.04
M 4.5	0.75	4.18	M 15	1.00	14.58	12	28	5.10
M 5	0.50	4.79	M 15	1.50	14.36	1/4	20	5.81
M 5	0.80	4.66	M 16	1.00	15.58	1/4	28	5.96
M 5.5	0.50	5.29	M 16	1.50	15.36	5/16	18	7.34
M 6	0.75	5.68	M 16	2.00	15.15	5/16	24	7.49
M 6	1.00	5.58	M 17	1.00	16.58	3/8	16	8.85
M 7	0.75	6.68	M 17	1.50	16.36	3/8	24	9.08
M 7	1.00	6.58	M 18	1.00	17.58	7/16	14	10.34
M 8	0.75	7.68	M 18	1.50	17.36	7/16	20	10.57
M 8	1.00	7.58	M 18	2.00	17.15	1/2	13	11.87
M 8	1.25	7.47	M 18	2.50	16.94	1/2	20	12.16
M 9	0.75	8.68	M 20	1.00	19.58	9/16	12	13.39
M 9	1.00	8.58	M 20	2.50	18.94	9/16	18	13.69
M 9	1.25	8.47				5/8	11	14.89
						5/8	18	15.28
						3/4	10	17.97
						3/4	16	18.38
						7/8	9	21.03
						7/8	14	21.45
						1	8	24.05
						1	12	24.50

Technical Information

DRILL SIZE FOR THREAD FORMING @ 65% THREAD								
Metric Threads			Metric Threads			UNC / UNF Threads		
Tap Dia.	Pitch mm	Drill size mm	Tap Dia.	Pitch mm	Drill size mm	Tap Size	TPI	Drill size mm
M 1	0.25	0.89	M 10	0.75	9.67	2	56	1.98
M 1.1	0.25	0.99	M 10	1.00	9.56	2	64	2.00
M 1.2	0.25	1.09	M 10	1.25	9.45	3	48	2.28
M 1.4	0.30	1.27	M 10	1.50	9.34	3	56	2.31
M 1.6	0.35	1.45	M 11	0.75	10.67	4	40	2.56
M 1.7	0.35	1.55	M 11	1.00	10.56	4	48	2.61
M 1.8	0.35	1.65	M 11	1.50	10.34	5	40	2.89
M 2	0.40	1.82	M 12	1.00	11.56	5	44	2.92
M 2.2	0.45	2.00	M 12	1.25	11.45	6	32	3.15
M 2.3	0.40	2.12	M 12	1.50	11.34	6	40	3.22
M 2.5	0.45	2.30	M 12	1.75	11.23	8	32	3.81
M 2.6	0.45	2.40	M 14	1.00	13.56	8	36	3.85
M 3	0.50	2.78	M 14	1.25	13.45	10	24	4.36
M 3.5	0.60	3.23	M 14	1.50	13.34	10	32	4.48
M 4	0.70	3.69	M 14	2.00	13.12	12	24	5.02
M 4.5	0.75	4.17	M 15	1.00	14.56	12	28	5.09
M 5	0.50	4.78	M 15	1.50	14.34	1/4	20	5.79
M 5	0.80	4.65	M 16	1.00	15.56	1/4	28	5.95
M 5.5	0.50	5.28	M 16	1.50	15.34	5/16	18	7.31
M 6	0.75	5.67	M 16	2.00	15.12	5/16	24	7.47
M 6	1.00	5.56	M 17	1.00	16.56	3/8	16	8.82
M 7	0.75	6.67	M 17	1.50	16.34	3/8	24	9.06
M 7	1.00	6.56	M 18	1.00	17.56	7/16	14	10.31
M 8	0.75	7.67	M 18	1.50	17.34	7/16	20	10.55
M 8	1.00	7.56	M 18	2.00	17.12	1/2	13	11.84
M 8	1.25	7.45	M 18	2.50	16.90	1/2	20	12.14
M 9	0.75	8.67	M 20	1.00	19.56	9/16	12	13.35
M 9	1.00	8.56	M 20	2.50	18.90	9/16	18	13.66
M 9	1.25	8.45				5/8	11	14.85
						5/8	18	15.25
						3/4	10	17.93
						3/4	16	18.35
						7/8	9	20.98
						7/8	14	21.42
						1	8	24.00
						1	12	24.46

DRILL SIZE FOR THREAD FORMING @ 67.5% THREAD								
Metric Threads			Metric Threads			UNC / UNF Threads		
Tap Dia.	Pitch mm	Drill size mm	Tap Dia.	Pitch mm	Drill size mm	Tap Size	TPI	Drill size mm
M 1	0.25	0.89	M 10	0.75	9.66	2	56	1.98
M 1.1	0.25	0.99	M 10	1.00	9.54	2	64	2.00
M 1.2	0.25	1.09	M 10	1.25	9.43	3	48	2.27
M 1.4	0.30	1.26	M 10	1.50	9.31	3	56	2.31
M 1.6	0.35	1.44	M 11	0.75	10.66	4	40	2.55
M 1.7	0.35	1.54	M 11	1.00	10.54	4	48	2.60
M 1.8	0.35	1.64	M 11	1.50	10.31	5	40	2.88
M 2	0.40	1.82	M 12	1.00	11.54	5	44	2.91
M 2.2	0.45	1.99	M 12	1.25	11.43	6	32	3.14
M 2.3	0.40	2.12	M 12	1.50	11.31	6	40	3.21
M 2.5	0.45	2.29	M 12	1.75	11.20	8	32	3.80
M 2.6	0.45	2.39	M 14	1.00	13.54	8	36	3.84
M 3	0.50	2.77	M 14	1.25	13.43	10	24	4.34
M 3.5	0.60	3.22	M 14	1.50	13.31	10	32	4.46
M 4	0.70	3.68	M 14	2.00	13.08	12	24	5.00
M 4.5	0.75	4.16	M 15	1.00	14.54	12	28	5.07
M 5	0.50	4.77	M 15	1.50	14.31	1/4	20	5.77
M 5	0.80	4.63	M 16	1.00	15.54	1/4	28	5.93
M 5.5	0.50	5.27	M 16	1.50	15.31	5/16	18	7.29
M 6	0.75	5.66	M 16	2.00	15.08	5/16	24	7.45
M 6	1.00	5.54	M 17	1.00	16.54	3/8	16	8.80
M 7	0.75	6.66	M 17	1.50	16.31	3/8	24	9.04
M 7	1.00	6.54	M 18	1.00	17.54	7/16	14	10.28
M 8	0.75	7.66	M 18	1.50	17.31	7/16	20	10.53
M 8	1.00	7.54	M 18	2.00	17.08	1/2	13	11.80
M 8	1.25	7.43	M 18	2.50	16.85	1/2	20	12.12
M 9	0.75	8.66	M 20	1.00	19.54	9/16	12	13.32
M 9	1.00	8.54	M 20	2.50	18.85	9/16	18	13.64
M 9	1.25	8.43				5/8	11	14.82
						5/8	18	15.23
						3/4	10	17.88
						3/4	16	18.32
						7/8	9	20.93
						7/8	14	21.39
						1	8	23.94
						1	12	24.43

DRILL SIZE FOR THREAD FORMING @ 70% THREAD								
Metric Threads			Metric Threads			UNC / UNF Threads		
Tap Dia.	Pitch mm	Drill size mm	Tap Dia.	Pitch mm	Drill size mm	Tap Size	TPI	Drill size mm
M 1	0.25	0.88	M 10	0.75	9.64	2	56	1.97
M 1.1	0.25	0.98	M 10	1.00	9.52	2	64	2.00
M 1.2	0.25	1.08	M 10	1.25	9.41	3	48	2.26
M 1.4	0.30	1.26	M 10	1.50	9.29	3	56	2.30
M 1.6	0.35	1.43	M 11	0.75	10.64	4	40	2.54
M 1.7	0.35	1.53	M 11	1.00	10.52	4	48	2.59
M 1.8	0.35	1.63	M 11	1.50	10.29	5	40	2.87
M 2	0.40	1.81	M 12	1.00	11.52	5	44	2.90
M 2.2	0.45	1.99	M 12	1.25	11.41	6	32	3.13
M 2.3	0.40	2.11	M 12	1.50	11.29	6	40	3.20
M 2.5	0.45	2.29	M 12	1.75	11.17	8	32	3.79
M 2.6	0.45	2.39	M 14	1.00	13.52	8	36	3.83
M 3	0.50	2.76	M 14	1.25	13.41	10	24	4.32
M 3.5	0.60	3.21	M 14	1.50	13.29	10	32	4.45
M 4	0.70	3.67	M 14	2.00	13.05	12	24	4.98
M 4.5	0.75	4.14	M 15	1.00	14.52	12	28	5.05
M 5	0.50	4.76	M 15	1.50	14.29	1/4	20	5.75
M 5	0.80	4.62	M 16	1.00	15.52	1/4	28	5.92
M 5.5	0.50	5.26	M 16	1.50	15.29	5/16	18	7.27
M 6	0.75	5.64	M 16	2.00	15.05	5/16	24	7.43
M 6	1.00	5.52	M 17	1.00	16.52	3/8	16	8.77
M 7	0.75	6.64	M 17	1.50	16.29	3/8	24	9.02
M 7	1.00	6.52	M 18	1.00	17.52	7/16	14	10.25
M 8	0.75	7.64	M 18	1.50	17.29	7/16	20	10.51
M 8	1.00	7.52	M 18	2.00	17.05	1/2	13	11.77
M 8	1.25	7.41	M 18	2.50	16.81	1/2	20	12.10
M 9	0.75	8.64	M 20	1.00	19.52	9/16	12	13.28
M 9	1.00	8.52	M 20	2.50	18.81	9/16	18	13.62
M 9	1.25	8.41				5/8	11	14.78
						5/8	18	15.20
						3/4	10	17.84
						3/4	16	18.29
						7/8	9	20.88
						7/8	14	21.36
						1	8	23.89
						1	12	24.39

DRILL SIZE FOR THREAD FORMING @ 72.5% THREAD								
Metric Threads			Metric Threads			UNC / UNF Threads		
Tap Dia.	Pitch mm	Drill size mm	Tap Dia.	Pitch mm	Drill size mm	Tap Size	TPI	Drill size mm
M 1	0.25	0.88	M 10	0.75	9.63	2	56	1.96
M 1.1	0.25	0.98	M 10	1.00	9.51	2	64	1.99
M 1.2	0.25	1.08	M 10	1.25	9.38	3	48	2.25
M 1.4	0.30	1.25	M 10	1.50	9.26	3	56	2.29
M 1.6	0.35	1.43	M 11	0.75	10.63	4	40	2.53
M 1.7	0.35	1.53	M 11	1.00	10.51	4	48	2.58
M 1.8	0.35	1.63	M 11	1.50	10.26	5	40	2.86
M 2	0.40	1.80	M 12	1.00	11.51	5	44	2.89
M 2.2	0.45	1.98	M 12	1.25	11.38	6	32	3.11
M 2.3	0.40	2.10	M 12	1.50	11.26	6	40	3.19
M 2.5	0.45	2.28	M 12	1.75	11.14	8	32	3.77
M 2.6	0.45	2.38	M 14	1.00	13.51	8	36	3.82
M 3	0.50	2.75	M 14	1.25	13.38	10	24	4.30
M 3.5	0.60	3.20	M 14	1.50	13.26	10	32	4.43
M 4	0.70	3.65	M 14	2.00	13.01	12	24	4.96
M 4.5	0.75	4.13	M 15	1.00	14.51	12	28	5.04
M 5	0.50	4.75	M 15	1.50	14.26	1/4	20	5.72
M 5	0.80	4.61	M 16	1.00	15.51	1/4	28	5.90
M 5.5	0.50	5.25	M 16	1.50	15.26	5/16	18	7.24
M 6	0.75	5.63	M 16	2.00	15.01	5/16	24	7.42
M 6	1.00	5.51	M 17	1.00	16.51	3/8	16	8.74
M 7	0.75	6.63	M 17	1.50	16.26	3/8	24	9.00
M 7	1.00	6.51	M 18	1.00	17.51	7/16	14	10.22
M 8	0.75	7.63	M 18	1.50	17.26	7/16	20	10.49
M 8	1.00	7.51	M 18	2.00	17.01	1/2	13	11.74
M 8	1.25	7.38	M 18	2.50	16.77	1/2	20	12.07
M 9	0.75	8.63	M 20	1.00	19.51	9/16	12	13.24
M 9	1.00	8.51	M 20	2.50	18.77	9/16	18	13.59
M 9	1.25	8.38				5/8	11	14.74
						5/8	18	15.18
						3/4	10	17.80
						3/4	16	18.27
						7/8	9	20.83
						7/8	14	21.33
						1	8	23.84
						1	12	24.36

Technical Information

Tapping Formulas and Calculations

RPM for UNC/UNF Taps

$$\text{RPM} = (\text{revolution / minute}) = \frac{\text{cutting speed (SFM)} \times 3.82}{\text{tap diameter}}$$

Feed Rate for UNC/UNF Taps

$$\text{IPR} = (\text{inch / revolution}) = \frac{1 \text{ inch}}{\text{threads per inch (TPI)}}$$

$$\text{IPM} = (\text{inch / minute}) = \frac{\text{RPM}}{\text{threads per inch (TPI)}}$$

RPM for M/MF Taps

$$\text{RPM} = (\text{revolution / minute}) = \frac{\text{cutting speed (SFM)} \times 97.028}{\text{tap diameter (mm)}}$$

Feed Rate for M/MF Taps

$$\text{IPR} = (\text{inch / revolution}) = \text{pitch (mm)} \times 0.03937$$

$$\text{IPM} = (\text{inch / minute}) = \text{RPM} \times \text{pitch (mm)} \times 0.03937$$

To calculate Tap Drill Size

UNC/UNF and M/MF Cut Taps – General Requirements

$$\text{Tap Drill Size} = \text{Tap basic major diameter} - \text{pitch}$$

UNC/UNF Cut Taps – Special Percentage of Thread Requirements

$$\text{Drill Size} = \text{Basic major diameter} - \frac{0.01299 \times \text{desired percentage of thread}^*}{\text{threads per inch (TPI)}}$$

M/MF Cut Taps – Special Percentage of Thread Requirements

$$\text{Drill Size (mm)} = \text{Basic major diameter} - \frac{\text{desired percentage of thread}^* \times \text{pitch (mm)}}{76.98}$$

UNC/UNF and M/MF Form Taps – General Requirements

$$\text{Tap Drill Size} = \text{Basic major diameter} - \frac{\text{pitch}}{2}$$

UNC/UNF Form Taps – Special Percentage of Thread Requirements

$$\text{Drill Size} = \text{Basic major diameter} - \frac{0.0068 \times \text{desired percentage of thread}^*}{\text{threads per inch (TPI)}}$$

M/MF Form Taps – Special Percentage of Thread Requirements

$$\text{Drill Size (mm)} = \text{Basic major diameter} - \frac{\text{desired percentage of thread}^* \times \text{pitch (mm)}}{147.06}$$

* Actual percentage will vary from desired percentage due to runout of drilling operation.

Technical Information

Troubleshooting - Application problems with new taps

Problem

Possible causes

Solution

1 Thread produced is too large



- incorrect tap, tap geometry not suitable for the application
- tapping size hole too small
- alignment error of tapping size hole or position
- machine spindle axially restricted
- cold welding at the flank of the tap
- lead of tap unsatisfactory due to insufficient thread depth
- cutting speed too high
- insufficient lubrication or coolant supply
- tolerance specification on tap does not correspond to specifications on drawing and/or thread gauge

- apply correct tap for the material to be machined
- observe tapping size hole table in the technical section. Note different tapping size hole diameters for fluteless taps.
- - check for correct tool clamping
- - apply floating tap holder
- - check core drill
- - use mechanical feed
- - apply tension/compression tap chuck
- - apply new tap
- - apply coated tap
- - optimize lubrication
- - tap with forced feed
- - apply tap with modified lead
- - reduce cutting speed
- - improve lubrication
- ensure sufficient and suitable coolant supply and check concentration
- apply correct tap for required tolerances

2 Thread axially miscut

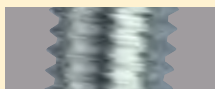

- spiral-fluted taps, corresponding to our design, are applied with too much pressure for initial tapping
- initial tapping pressure too low for taps with spiral point corresponding to our form "B"

- with spiral-fluted taps only light pressure required for initial tapping. The tap should immediately be applied within the tension/compression range
- taps with spiral point or left hand spiral require higher axial pressure. Ensure tap operates within the tension/compression range

3 Thread produced is too small

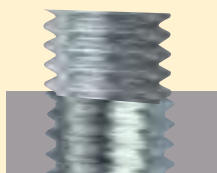

- tolerance specification on tap does not correspond to specifications on drawing and/or thread gauge
- incorrect tap
- tap does not cut accurately (thread plug gauge)
- machine spindle is axially too rigid

- apply correct tap for required tolerance
- apply correct tap for the material to be machined
- avoid strong axial forces during the cutting process
- apply tension/compression chuck

Troubleshooting - Application problems with new taps

Problem

Possible causes

Solution

4 Thread surface not according to requirements



- cutting edge geometry not suitable for the application
- cutting speed too high
- insufficient coolant (concentration and supply)
- chip congestion
- tapping size hole too small
- with tough, hard materials loading on tool too much or pitch too steep
- built-up edge
- cold welding

- apply "correct" tap for the material to be machined
- - reduce cutting speed
- - optimize lubrication
- ensure suitable coolant and sufficient volume
- apply suitable tap type
- observe tapping size hole diameter specifications to DIN 336 or respective standards. Observe table for fluteless taps
- apply hand tap sets
- apply coated tap
- improve coolant supply

5 Tool life insufficient

- surface hardening of tapping size hole
- reasons listed under: "thread surface not according to requirements"
- chip congestion

- - check drill (cutting edge) for wear
- - heat or surface treatment following thread production
- reasons listed under: thread surface "not according to requirements"
- apply correct tap

6 Tool breakage during advance or return



- tapping size hole too small
- teeth of chamfer lead overloaded
- tap hits bottom of tapping size hole
- - lack of or incorrect chamfer of tapping size hole
- - position or angle error of tapping size hole
- - tool hardness not suitable for the application
- - cutting edge geometry not suitable for the application

- observe tapping size hole dia. acc. to DIN 336 or respective standards
- - longer chamfer lead (blind or through hole)
- - increase no. of teeth of chamfer lead by increasing no. of flutes
- - apply tap sets
- - check hole depth
- - apply tension/compression tap chuck
- - correct chamfer angle of tapping size hole
- - ensure correct tool clamping
- - apply floating tap holder
- - check core drill
- apply suitable tap for the individual application

Appendix of Guhring Tap Part Numbers

Series	Thread Type	Substrate	Color Ring	Style of tap	Standard	Coolant	Chamfer	Helix	Surface	Tolerance	Page
169	Metric fine	Cobalt	white	blind or through	DIN 371		C		TiAlN coated	6HX	147
297	Metric	PM cobalt	red	blind hole	DIN 376	axial coolant	C		TiCN coated	6HX	115
297	Metric	PM cobalt	white	blind hole	DIN 376	axial coolant	C		TiCN coated	6HX	148
297	Metric	PM cobalt	black	blind hole	DIN 376	axial coolant	C		TiCN coated	6HX	167
302	Metric	PM cobalt	red	blind hole	DIN 371	axial coolant	C		TiCN coated	6HX	115
302	Metric	PM cobalt	white	blind hole	DIN 371	axial coolant	C		TiCN coated	6HX	148
302	Metric	PM cobalt	black	blind hole	DIN 371	axial coolant	C		TiCN coated	6HX	167
318	Metric	Cobalt	white	blind or through	DIN 371	axial coolant	C		TiAlN coated	6HX	145
319	Metric	Cobalt	white	blind or through	DIN 376	axial coolant	C		TiAlN coated	6HX	146
323	Metric	PM cobalt		form tap	DIN 371	radial coolant	C		TiN coated	6HX	192
338	Metric fine	PM cobalt		form tap	DIN 374	radial coolant	C		TiN coated	6HX	195
342	Metric	PM cobalt		form tap	DIN 376	radial coolant	C		TiN coated	6HX	193
347	Metric fine	Cobalt	white	blind or through	DIN 374	axial coolant	C		TiAlN coated	6HX	147
778	Metric	Cobalt	black	blind hole	DIN 376	axial coolant	C		TiCN coated	6HX	173
778	Metric	Cobalt	Red	blind hole	DIN 376	axial coolant	C		TiCN coated	6HX	117
778	Metric	Cobalt	white	blind hole	DIN 376	axial coolant	C		TiCN coated	6HX	153
779	Metric	Cobalt	black	blind hole	~DIN 376	axial coolant	C		TiCN coated	6HX	173
779	Metric	Cobalt	red	blind hole	~DIN 376	axial coolant	C		TiCN coated	6HX	117
779	Metric	Cobalt	white	blind hole	~DIN 376	axial coolant	C		TiCN coated	6HX	153
803	Metric	Cobalt	yellow	through hole	DIN 371		B		bright finish	ISO 2(6H)	40
804	Metric	Cobalt	red	through hole	DIN 371		B		bright finish	6H	107
810	Metric	Cobalt	yellow	blind hole	DIN 371		C	40°	bright finish	ISO 2(6H)	40
811	Metric	Cobalt	red	blind hole	DIN 371		C	40°	bright finish	ISO 2(6H)	107
815	Metric	Cobalt	yellow	through hole	DIN 376		B		bright finish	ISO 2(6H)	41
816	Metric	Cobalt	red	through hole	DIN 376		B		bright finish	ISO 2(6H)	108
822	Metric	Cobalt	yellow	blind hole	DIN 376		C	40°	bright finish	ISO 2(6H)	41
823	Metric	Cobalt	red	blind hole	DIN 376		C	40°	bright finish	ISO 2(6H)	108
827	Metric fine	Cobalt	yellow	through hole	DIN 374		B		bright finish	ISO 2(6H)	42
828	Metric fine	Cobalt	red	through hole	DIN 374		B		bright finish	ISO 2(6H)	109
830	Metric fine	Cobalt	yellow	blind or through	DIN 374		C		bright finish	ISO 2(6H)	44
834	Metric fine	Cobalt	yellow	blind hole	DIN 374		C	40°	bright finish	ISO 2(6H)	43
835	Metric fine	Cobalt	red	blind hole	DIN 374		C	40°	bright finish	ISO 2(6H)	109
877	Metric	PM cobalt	blue	through hole	DIN 371		B		bright finish	ISO 2(6H)	89
889	Metric	Cobalt	green	blind hole	DIN 371		C	40°	bright finish	ISO 2(6H)	74
890	Metric	Cobalt	green	blind hole	DIN 376		C	40°	bright finish	ISO 2(6H)	75
909	Metric	PM cobalt	blue	blind hole	DIN 371		C	40°	bright finish	ISO 2(6H)	89
910	Metric	PM cobalt	blue	blind hole	DIN 376		C	40°	bright finish	ISO 2(6H)	93
919	Metric	Cobalt		form tap	DIN 371		C		TiN coated	6HX	190
921	Metric Micro	Cobalt	brown	form tap	DIN 371		C		TiN coated	6HX	191
923	Metric	Cobalt		form tap	DIN 376	axial coolant	C		TiN coated	6HX	190
927	Metric fine	Cobalt		form tap	DIN 374		C		TiN coated	6HX	191
936	Metric fine	PM cobalt	blue	blind hole	DIN 374		C	40°	bright finish	ISO 2(6H)	93
969	Metric	Carbide	black	blind or through	DIN 371	axial coolant	C		bright finish	ISO 2(6H)	170
969	Metric	Carbide	white	blind or through	DIN 371	axial coolant	C		bright finish	ISO 2(6H)	151
971	Metric	Carbide	black	blind hole	DIN 371	axial coolant	C	15°	bright finish	ISO 2(6H)	172
974	Metric fine	Carbide	black	blind hole	DIN 374	axial coolant	C		bright finish	6HX	170
974	Metric fine	Carbide	white	blind hole	DIN 374	axial coolant	C		bright finish	6HX	151
977	Metric fine	Carbide	black	blind hole	DIN 371	axial coolant	C	15°	bright finish	6HX	172
978	Metric fine	Carbide	black	blind hole	DIN 374	axial coolant	C	15°	bright finish	ISO 2(6H)	172
998	Metric - XL	Cobalt	yellow	through hole	DIN 357		B		bright finish	ISO 2(6H)	43
1007	Metric fine	PM cobalt	black	blind hole	DIN 374	axial coolant	E		TiCN coated	6HX	168
1007	Metric fine	PM cobalt	red	blind hole	DIN 374	axial coolant	E		TiCN coated	6HX	116
1007	Metric fine	PM cobalt	white	blind hole	DIN 374	axial coolant	E		TiCN coated	6HX	149
1008	Metric	Carbide	black	blind hole	DIN 371	axial coolant	E		bright finish	6HX	169

* All carbide form taps will be changing to TiCN coating as inventory levels are replenished

Appendix of Guhring Tap Part Numbers

Series	Thread Type	Substrate	Color Ring	Style of tap	Standard	Coolant	Chamfer	Helix	Surface	Tolerance	Page
1008	Metric	Carbide	white	blind hole	DIN 371	axial coolant	E		bright finish	6HX	150
1009	Metric fine	Carbide	black	blind hole	DIN 374	axial coolant	E		bright finish	6HX	169
1009	Metric fine	Carbide	white	blind hole	DIN 374	axial coolant	E		bright finish	6HX	150
1010	Metric	Cobalt	green	through hole	EG M		B		TiN coated	6H mod	78
1011	Metric	Cobalt	green	blind hole	EG M		C		TiN coated	6H mod	78
1057	Metric "J"	PM cobalt	Ni/Ti	through hole	DIN 371/376		B		TiCN coated	4HX	132
1058	Metric "J" fine	PM cobalt	Ni/Ti	through hole	DIN 371		B		TiCN coated	4HX	133
1059	UNJC	PM cobalt	Ni/Ti	through hole	DIN 371/376		B		TiCN coated	3BX	130
1060	UNJF	PM cobalt	Ni/Ti	through hole	DIN 371/376		B		TiCN coated	3BX	131
1061	Metric "J"	PM cobalt	Ti	blind hole	DIN 371/376		C	15°	TiCN coated	4HX	132
1062	Metric "J" fine	PM cobalt	Ti	blind hole	DIN 371		C	15°	TiCN coated	4HX	133
1063	UNJC	PM cobalt	Ti	blind hole	DIN 371/376		C	15°	TiCN coated	3BX	130
1064	UNJF	PM cobalt	Ti	blind hole	DIN 371/376		C	15°	TiCN coated	3BX	131
1065	Metric "J"	PM cobalt	Ni	blind hole	DIN 371/376		C	10°	TiAlN coated	4HX	135
1066	Metric "J" fine	PM cobalt	Ni	blind hole	DIN 371		C	10°	TiAlN coated	4HX	135
1067	UNJC	PM cobalt	Ni	blind hole	DIN 371/376		C	10°	TiAlN coated	3BX	134
1068	UNJF	PM cobalt	Ni	blind hole	DIN 371/376		C	10°	TiAlN coated	3BX	134
1082	UNC	Cobalt	white	blind hole	DIN 371	axial coolant	C		TiAlN coated	2B	143
1085	UNC	Cobalt	white	blind hole	DIN 376	axial coolant	C		TiAlN coated	2B	141
1086	UNF	Cobalt	white	blind hole	DIN 374	axial coolant	C		TiAlN coated	2B	141
1088	NPT	Cobalt	blue	blind hole	Guhring Std.		C	25°	TiN coated		94
1090	Metric fine	PM cobalt	black	blind hole	DIN 374	axial coolant	C		TiCN coated	6HX	167
1090	Metric fine	PM cobalt	red	blind hole	DIN 374	axial coolant	C		TiCN coated	6HX	115
1090	Metric fine	PM cobalt	white	blind hole	DIN 374	axial coolant	C		TiCN coated	6HX	148
1091	Metric	PM cobalt	red	blind hole	DIN 371	axial coolant	E		TiCN coated	6HX	116
1091	Metric	PM cobalt	white	blind hole	DIN 371	axial coolant	E		TiCN coated	6HX	149
1091	Metric	PM cobalt	black	blind hole	DIN 371	axial coolant	E		TiCN coated	6HX	168
1152	Metric	PM cobalt	green	blind hole	DIN 371	axial coolant	C	50°	TiCN coated	6H	74
1161	Metric fine	Carbide	red	blind or through	Guhring Std.		D		TiCN coated	6HX	118
1188	Metric	PM cobalt	red	blind hole	DIN 371	axial coolant	C	15°	TiCN coated	6HX	114
1194	Metric	PM cobalt	red	blind hole	DIN 376	axial coolant	C	15°	TiCN coated	6HX	114
1200	Metric fine	PM cobalt	red	blind hole	DIN 376	axial coolant	C	15°	TiCN coated	6HX	114
1270	Metric	PM cobalt		form tap	DIN 371	radial coolant	C		TiCN coated	6HX	192
1271	Metric	PM cobalt		form tap	DIN 376	radial coolant	C		TiCN coated	6HX	193
1272	Metric fine	PM cobalt		form tap	DIN 371	radial coolant	C		TiCN coated	6HX	194
1273	Metric fine	PM cobalt		form tap	DIN 374	radial coolant	C		TiCN coated	6HX	195
1293	Metric	PM cobalt	green	blind hole	DIN 376	axial coolant	C	50°	TiCN coated	6H	75
1294	Metric fine	PM cobalt	green	blind hole	DIN 374	axial coolant	C	50°	TiCN coated	6H	76
1577	Metric	PM cobalt	red	blind hole	DIN 371		C	15°	TiAlN coated	ISO 2(6H)	113
1578	Metric	PM cobalt	red	blind hole	DIN 376		C	15°	TiAlN coated	ISO 2(6H)	113
1581	Metric fine	Carbide		form tap	DIN 374	radial coolant	C		TiAlN coated	6HX	199
1582	UNC	Cobalt		form tap	DIN 371		C		TiN coated	2BX	186
1583	UNC	Cobalt		form tap	DIN 376		C		TiN coated	2BX	186
1584	UNF	Cobalt		form tap	DIN 371		C		TiN coated	2BX	187
1585	UNF	Cobalt		form tap	DIN 376		C		TiN coated	2BX	187
1717	Metric	PM cobalt		form tap	DIN 371	radial coolant	C		TiAlN coated	6HX	192
1719	Metric	PM cobalt		form tap	DIN 376	radial coolant	C		TiAlN coated	6HX	193
1721	Metric fine	PM cobalt		form tap	DIN 371	radial coolant	C		TiAlN coated	6HX	194
1723	Metric fine	PM cobalt		form tap	DIN 374	radial coolant	C		TiAlN coated	6HX	195
1725	Metric	PM cobalt		form tap	DIN 371	axial coolant	E		TiN coated	6HX	196
1727	Metric	PM cobalt		form tap	DIN 376	axial coolant	E		TiN coated	6HX	196
1729	Metric fine	PM cobalt		form tap	DIN 371	axial coolant	E		TiN coated	6HX	197
1731	Metric fine	PM cobalt		form tap	DIN 374	axial coolant	E		TiN coated	6HX	197
1858	Metric	Carbide	black	blind or through	DIN 371	radial coolant	C		bright finish	ISO 2(6H)	171

* All carbide form taps will be changing to TiCN coating as inventory levels are replenished

Appendix of Guhring Tap Part Numbers

Series	Thread Type	Substrate	Color Ring	Style of tap	Standard	Coolant	Chamfer	Helix	Surface	Tolerance	Page
1858	Metric	Carbide	white	blind or through	DIN 371	radial coolant	C		bright finish	ISO 2(6H)	152
1859	Metric	Carbide	black	blind or through	DIN 376	radial coolant	C		bright finish	ISO 2(6H)	171
1859	Metric	Carbide	white	blind or through	DIN 376	radial coolant	C		bright finish	ISO 2(6H)	152
1860	Metric fine	Carbide	black	blind or through	DIN 371	radial coolant	C		bright finish	ISO 2(6H)	171
1860	Metric fine	Carbide	white	blind or through	DIN 374	radial coolant	C		bright finish	ISO 2(6H)	152
1872	Metric	Cobalt	blue	through hole	DIN 376		B		bright finish	ISO 2(6H)	90
1873	Metric Fine	Carbide	blue	through hole	DIN 374		B		bright finish	ISO 2(6H)	90
1883	Metric	Carbide	black	blind hole	DIN 376	axial coolant	C		bright finish	ISO 2(6H)	170
1883	Metric	Carbide	white	blind hole	DIN 376	axial coolant	C		bright finish	ISO 2(6H)	151
1894	Metric	Cobalt	red	blind hole	DIN 371	axial coolant	C	40°	bright finish	ISO 2(6H)	112
1901	Metric	Cobalt	red	blind hole	DIN 376	axial coolant	C	40°	bright finish	ISO 2(6H)	112
1914	Metric	Cobalt	red	through hole	DIN 371		B		TiCN coated	ISO 2(6H)	110
1915	Metric	Cobalt	red	through hole	DIN 376		B		TiCN coated	ISO 2(6H)	111
1916	Metric	Cobalt	red	blind hole	DIN 371		C	40°	TiCN coated	ISO 2(6H)	110
1917	Metric	Cobalt	red	blind hole	DIN 376		C	40°	TiCN coated	ISO 2(6H)	111
1918	Metric	Cobalt	white	blind or through	DIN 371		C		TiAlN coated	6HX	145
1919	Metric	Cobalt	white	blind or through	DIN 376		C		TiAlN coated	6HX	146
1927	Metric	Carbide		form tap	DIN 371	radial coolant	E		TiAlN coated	6HX	198
1931	Metric	Carbide		form tap	DIN 376	radial coolant	C		TiAlN coated	6HX	198
1972	Metric	Carbide		form tap	DIN 371	radial coolant	C		TiAlN coated	6HX	198
1979	UNC	Cobalt	white	blind or through	DIN 371		C		oxide finish	2B	141
1984	UNC	Cobalt	white	blind or through	DIN 376		C		oxide finish	2B	142
1989	UNF	Cobalt	white	blind or through	DIN 374		C		oxide finish	2B	143
2424	Metric fine	Cobalt	green	blind hole	DIN 374		C	40°	bright finish	ISO 2(6H)	76
2790	Metric	Cobalt	green	blind hole	DIN 371		E	40°	bright finish	ISO 2(6H)	74
2791	Metric	Cobalt	green	blind hole	DIN 376		E	40°	bright finish	ISO 2(6H)	75
2792	Metric fine	Cobalt	green	blind hole	DIN 374		E	40°	bright finish	ISO 2(6H)	76
2876	Metric	Cobalt	green	through hole	DIN 371		B		oxide finish	6H	71
2879	Metric fine	Cobalt	green	through hole	DIN 374		B		oxide finish	ISO 2(6H)	71
2895	Metric	Cobalt	blue	blind hole	DIN 376		C	15°	TiN coated	ISO 2(6H)	91
2896	Metric	Cobalt	blue	blind hole	DIN 371		C	15°	TiN coated	ISO 2(6H)	91
2897	Metric fine	Cobalt	blue	blind hole	DIN 374		C	15°	TiN coated	ISO 2(6H)	92
2901	Metric	PM cobalt	Ti	through hole	DIN 371		B		TiCN coated	6HX	124
2903	Metric fine	PM cobalt	Ti	through hole	DIN 371		B		TiCN coated	6HX	125
2905	UNC	PM cobalt	Ti	through hole	DIN 371		B		TiCN coated	2BX	122
2907	UNF	PM cobalt	Ti	through hole	DIN 371		B		TiCN coated	2BX	123
2909	Metric	PM cobalt	Ti	blind hole	DIN 371		C	15°	TiCN coated	6HX	124
2910	Metric fine	PM cobalt	Ti	blind hole	DIN 371		C	15°	TiCN coated	6HX	125
2912	UNC	PM cobalt	Ti	blind hole	DIN 371		C	15°	TiCN coated	2BX	122
2914	UNF	PM cobalt	Ti	blind hole	DIN 371		C	15°	TiCN coated	2BX	123
2916	Metric	PM cobalt	Ni	through hole	DIN 371		B		TiAlN coated	6HX	128
2917	Metric fine	PM cobalt	Ni	through hole	DIN 371		B		TiAlN coated	6HX	129
2918	UNC	PM cobalt	Ni	through hole	DIN 371		B		TiAlN coated	2BX	126
2919	UNF	PM cobalt	Ni	through hole	DIN 371		B		TiAlN coated	2BX	127
2920	Metric	PM cobalt	Ni	blind hole	DIN 371		C	10°	TiAlN coated	6HX	128
2921	Metric fine	PM cobalt	Ni	blind hole	DIN 371		C	10°	TiAlN coated	6HX	129
2922	UNC	PM cobalt	Ni	blind hole	DIN 371		C	10°	TiAlN coated	2BX	126
2923	UNF	PM cobalt	Ni	blind hole	DIN 371		C	10°	TiAlN coated	2BX	127
2944	Metric	Carbide	red	blind hole	Guhring Std.		D	0°	TiCN coated	ISO 2(6H)	118
3900	Metric	Cobalt	yellow	through hole	ANSI		B		bright finish	6H	38
3901	UNC	Cobalt	yellow	through hole	ANSI		B		bright finish	2B	34
3902	UNF	Cobalt	yellow	through hole	ANSI		B		bright finish	2B	35
3903	Metric	Cobalt	yellow	blind hole	ANSI		C	40°	bright finish	6H	38
3904	UNC	Cobalt	yellow	blind hole	ANSI		C	40°	bright finish	2B	34

* All carbide form taps will be changing to TiCN coating as inventory levels are replenished

Appendix of Guhring Tap Part Numbers

Series	Thread Type	Substrate	Color Ring	Style of tap	Standard	Coolant	Chamfer	Helix	Surface	Tolerance	Page
3905	UNF	Cobalt	yellow	blind hole	ANSI		C	40°	bright finish	2B	35
3906	Metric	PM cobalt	blue	through hole	ANSI		B		TiN coated	6H	88
3907	UNC	PM cobalt	blue	through hole	ANSI		B		TiN coated	2B	84
3908	UNF	PM cobalt	blue	through hole	ANSI		B		TiN coated	2B	85
3909	Metric	PM cobalt	blue	blind hole	ANSI		C	40°	TiN coated	6H	88
3910	UNC	PM cobalt	blue	blind hole	ANSI		C	40°	TiN coated	2B	84
3911	UNF	PM cobalt	blue	blind hole	ANSI		C	40°	TiN coated	2B	85
3912	Metric	Cobalt	green	through hole	ANSI		B		bright finish	6H	66
3913	UNC	Cobalt	green	through hole	ANSI		B		bright finish	2B	48
3914	UNF	Cobalt	green	through hole	ANSI		B		bright finish	2B	49
3915	Metric	Cobalt	green	through hole	ANSI		B		TiN coated	6H	67
3916	UNC	Cobalt	green	through hole	ANSI		B		TiN coated	2B	50
3917	UNF	Cobalt	green	through hole	ANSI		B		TiN coated	2B	51
3918	Metric	Cobalt	green	blind hole	ANSI		C	40°	bright finish	6H	66
3919	UNC	Cobalt	green	blind hole	ANSI		C	40°	bright finish	2B	48
3920	UNF	Cobalt	green	blind hole	ANSI		C	40°	bright finish	2B	49
3921	Metric	Cobalt	green	blind hole	ANSI		C	40°	TiN coated	6H	67
3922	UNC	Cobalt	green	blind hole	ANSI		C	40°	TiN coated	2B	50
3923	UNF	Cobalt	green	blind hole	ANSI		C	40°	TiN coated	2B	51
3924	Metric	Cobalt	black	through hole	ANSI		B		bright finish	6H	164
3925	UNC	Cobalt	black	through hole	ANSI		B		bright finish	2B	156
3926	UNF	Cobalt	black	through hole	ANSI		B		bright finish	2B	157
3927	Metric	Cobalt	black	through hole	ANSI		B		TiN coated	6H	165
3928	UNC	Cobalt	black	through hole	ANSI		B		TiN coated	2B	158
3929	UNF	Cobalt	black	through hole	ANSI		B		TiN coated	2B	159
3930	Metric	Cobalt	black	blind hole	ANSI		C	45°	bright finish	6H	164
3931	UNC	Cobalt	black	blind hole	ANSI		C	45°	bright finish	2B	156
3932	UNF	Cobalt	black	blind hole	ANSI		C	45°	bright finish	2B	157
3933	Metric	Cobalt	black	blind hole	ANSI		C	45°	TiN coated	6H	165
3934	UNC	Cobalt	black	blind hole	ANSI		C	45°	TiN coated	2B	158
3935	UNF	Cobalt	black	blind hole	ANSI		C	45°	TiN coated	2B	159
3936	Metric	Cobalt	white	blind or through	ANSI		C		FIREX® coated	6HX	144
3937	UNC	Cobalt	white	blind or through	ANSI		C		FIREX® coated	2B	138
3938	UNF	Cobalt	white	blind or through	ANSI		C		FIREX® coated	2B	138
3939	Metric	Cobalt		form tap	ANSI		C		TiN coated	6HX	188
3940	UNC	Cobalt		form tap	ANSI		C		TiN coated	2BX	180
3941	UNF	Cobalt		form tap	ANSI		C		TiN coated	2BX	180
3942	Metric	Cobalt		form tap	ANSI		C		TiCN coated	6HX	189
3943	UNC	Cobalt		form tap	ANSI		C		TiCN coated	2BX	181
3944	UNF	Cobalt		form tap	ANSI		C		TiCN coated	2BX	181
3945	Metric	Cobalt	green	through hole	ANSI		B		TiCN coated	6H	68
3946	UNC	Cobalt	green	through hole	ANSI		B		TiCN coated	2B	52
3947	UNF	Cobalt	green	through hole	ANSI		B		TiCN coated	2B	53
3948	Metric	Cobalt	green	blind hole	ANSI		C	40°	TiCN coated	6H	68
3949	UNC	Cobalt	green	blind hole	ANSI		C	40°	TiCN coated	2B	52
3950	UNF	Cobalt	green	blind hole	ANSI		C	40°	TiCN coated	2B	53
3954	UNC	Cobalt	green	blind hole	ANSI	axial coolant	C	40°	TiN coated	2B	59
3955	UNF	Cobalt	green	blind hole	ANSI	axial coolant	C	40°	TiN coated	2B	59
3959	UNC	Cobalt		form tap	ANSI		E		TiN coated	2BX	184
3960	Metric	Cobalt	yellow	through hole	ANSI		B		MolyGlide®	6H	39
3961	UNC	Cobalt	yellow	through hole	ANSI		B		MolyGlide®	2B	36
3962	UNF	Cobalt	yellow	through hole	ANSI		B		MolyGlide®	2B	37
3963	Metric	Cobalt	yellow	blind hole	ANSI		C	40°	MolyGlide®	6H	39
3964	UNC	Cobalt	yellow	blind hole	ANSI		C	40°	MolyGlide®	2B	36

Appendix of Guhring Tap Part Numbers

Series	Thread Type	Substrate	Color Ring	Style of tap	Standard	Coolant	Chamfer	Helix	Surface	Tolerance	Page
3965	UNF	Cobalt	yellow	blind hole	ANSI		C	40°	MolyGlide®	2B	37
3966	Metric	Cobalt	black	through hole	ANSI		B		MolyGlide®	6H	166
3967	UNC	Cobalt	black	through hole	ANSI		B		MolyGlide®	2B	160
3968	UNF	Cobalt	black	through hole	ANSI		B		MolyGlide®	2B	161
3969	Metric	Cobalt	black	blind hole	ANSI		C	45°	MolyGlide®	6H	166
3970	UNC	Cobalt	black	blind hole	ANSI		C	45°	MolyGlide®	2B	160
3971	UNF	Cobalt	black	blind hole	ANSI		C	45°	MolyGlide®	2B	161
3972	UNF	Cobalt		form tap	ANSI		E		TiN coated	2BX	184
3973	Metric fine	Cobalt	green	through hole	ANSI		B		TiN coated	6H	69
3974	Metric fine	Cobalt	green	blind hole	ANSI		C	40°	TiN coated	6H	69
3975	Metric fine	Cobalt		form tap	ANSI		C		TiN coated	6HX	188
3976	Metric	Cobalt	green	blind hole	ANSI		E	40°	TiN coated	6H	70
3977	UNC	Cobalt	green	blind hole	ANSI		E	40°	TiN coated	2B	58
3978	UNF	Cobalt	green	blind hole	ANSI		E	40°	TiN coated	2B	58
3979	Metric	Cobalt		form tap	ANSI		E		TiN coated	6HX	189
3980	UNC/oversized	Cobalt	green	blind hole	ANSI		C	40°	TiN coated	H7	54
3981	UNF/oversized	Cobalt	green	blind hole	ANSI		C	40°	TiN coated	H7	55
3982	UNC/oversized	Cobalt	green	through hole	ANSI		B		TiN coated	H7	54
3983	UNF/oversized	Cobalt	green	through hole	ANSI		B		TiN coated	H7	55
3984	UNC/oversized	Cobalt	green	blind hole	ANSI		C	40°	TiN coated	H11	56
3985	UNF/oversized	Cobalt	green	blind hole	ANSI		C	40°	TiN coated	H11	57
3986	UNC/oversized	Cobalt	green	through hole	ANSI		B		TiN coated	H11	56
3987	UNF/oversized	Cobalt	green	through hole	ANSI		B		TiN coated	H11	57
3988	UNC / STI	Cobalt	green	blind hole	STI Tap		C	40°	TiN coated	3B	64
3989	UNF / STI	Cobalt	green	blind hole	STI Tap		C	40°	TiN coated	3B	65
3990	UNC / STI	Cobalt	green	through hole	STI Tap		B		TiN coated	3B	64
3991	UNF / STI	Cobalt	green	through hole	STI Tap		B		TiN coated	3B	65
3992	UNC	PM cobalt	red	through hole	DIN / ANSI		B		TiN coated	2B	98
3993	UNC	PM cobalt	red	blind hole	DIN / ANSI		C	40°	TiN coated	2B	98
3994	UNF	PM cobalt	red	through hole	DIN / ANSI		B		TiN coated	2B	99
3995	UNF	PM cobalt	red	blind hole	DIN / ANSI		C	40°	TiN coated	2B	99
3996	UNC	Cobalt	blue	through hole	ANSI		B		TiN coated	3B	86
3997	UNF	Cobalt	blue	through hole	ANSI		B		TiN coated	3B	87
3998	UNC	Cobalt	blue	blind hole	ANSI		C	40°	TiN coated	3B	86
3999	UNF	Cobalt	blue	blind hole	ANSI		C	40°	TiN coated	3B	87
4118	UNC	Carbide	black	blind hole	DIN/ANSI	axial coolant	C		bright finish	2B	163
4118	UNC	Carbide	white	blind hole	DIN/ANSI	axial coolant	C		bright finish	2B	140
4119	UNF	Carbide	black	blind hole	DIN/ANSI	axial coolant	C		bright finish	2B	163
4119	UNF	Carbide	white	blind hole	DIN/ANSI	axial coolant	C		bright finish	2B	140
4120	Metric	PM cobalt	red	blind hole	DIN / ANSI		C		TiN coated	6H	105
4121	Metric Fine	PM cobalt	red	blind hole	DIN / ANSI		C		TiN coated	6H	106
4122	Metric	PM cobalt	red	through hole	DIN / ANSI		B		TiN coated	6H	105
4123	Metric Fine	PM cobalt	red	through hole	DIN / ANSI		B		TiN coated	6H	106
4124	UNC	PM cobalt	red	blind hole	DIN / ANSI		C	15°	TiN coated	2B	100
4125	UNF	PM cobalt	red	blind hole	DIN / ANSI		C	15°	TiN coated	2B	100
4126	Metric	Cobalt	green	blind hole	ANSI	axial coolant	C	40°	TiN coated	2B	70
4127	NPTF	Cobalt	blue	blind hole	Guhring Std.		C	25°	TiN coated		94
4154	Metric	Cobalt	green	blind hole	DIN 371		C	15°	TiCN coated	6H	72
4155	Metric Fine	Cobalt	green	blind hole	DIN 374		E	15°	TiCN coated	6H	73
4156	Metric	Cobalt	green	blind hole	DIN 371		C	15°	TiCN coated	6H	72
4157	Metric Fine	Cobalt	green	blind hole	DIN 374		E	15°	TiCN coated	6H	73
4165	Metric	PM cobalt	black	blind hole	DIN 376	axial coolant	E		TiCN coated	6HX	168
4165	Metric	PM cobalt	red	blind hole	DIN 376	axial coolant	E		TiCN coated	6HX	116
4165	Metric	PM cobalt	white	blind hole	DIN 376	axial coolant	E		TiCN coated	6HX	149

* All carbide form taps will be changing to TiCN coating as inventory levels are replenished

Appendix of Guhring Tap Part Numbers

Series	Thread Type	Substrate	Color Ring	Style of tap	Standard	Coolant	Chamfer	Helix	Surface	Tolerance	Page
4282	UNF	Cobalt	green	through hole	ANSI		B		TiN coated	2B	61
4283	UNC	Cobalt	green	blind hole	ANSI		C	40°	TiN coated	2B	60
4284	UNF	Cobalt	green	blind hole	ANSI		C	40°	TiN coated	2B	61
4285	UNC	Cobalt	green	through hole	ANSI		B		TiN coated	2B	62
4286	UNF	Cobalt	green	through hole	ANSI		B		TiN coated	2B	63
4287	UNC	Cobalt	green	blind hole	ANSI		C	40°	TiN coated	2B	62
4288	UNF	Cobalt	green	blind hole	ANSI		C	40°	TiN coated	2B	63
4289	8-pitch	Cobalt	green	blind hole	DIN/ANSI		C	40°	TiN coated	2B	81
4311	Metric	Cobalt	green	blind hole	DIN 371		C	40°	TiN coated	6H	77
4331	Metric	Cobalt	green	through hole	DIN 371		B		TiN coated	6H	77
4373	UNC	PM cobalt	red	blind hole	DIN/ANSI		E	15°	TiCN coated	2BX	102
4374	UNF	PM cobalt	red	blind hole	DIN/ANSI		E	15°	TiCN coated	2BX	103
4375	UNC	PM cobalt	red	blind hole	DIN/ANSI	axial coolant	E	15°	TiCN coated	2BX	102
4376	UNF	PM cobalt	red	blind hole	DIN/ANSI	axial coolant	E	15°	TiCN coated	2BX	103
4377	UNC	PM cobalt	brown	form tap	DIN/ANSI		C		TiCN coated	2BX	182
4378	UNF	PM cobalt	brown	form tap	DIN/ANSI		C		TiCN coated	2BX	182
4379	UNC	PM cobalt	brown	form tap	DIN/ANSI	radial coolant	C		TiCN coated	2BX	183
4380	UNF	PM cobalt	brown	form tap	DIN/ANSI	radial coolant	C		TiCN coated	2BX	183
4382	UNF	PM cobalt	brown	form tap	DIN/ANSI	axial coolant	E		TiN coated	2BX	185
4383	UNC	PM cobalt	brown	form tap	DIN/ANSI	axial coolant	E		TiN coated	2BX	185
4388	UNC	PM cobalt	red	blind hole	DIN/ANSI	axial coolant	C	15°	TiCN coated	2BX	101
4389	UNF	PM cobalt	red	blind hole	DIN/ANSI	axial coolant	C	15°	TiCN coated	2BX	101
4390	UNC	Cobalt	green	through hole	ANSI		B		TiN coated	2B	60
4391	UNF	PM Cobalt	red	through hole	DIN/ANSI	axial coolant	C		TiCN coated	2BX	104
4391	UNF	PM Cobalt	white	through hole	DIN/ANSI	axial coolant	C		TiCN coated	2BX	139
4391	UNF	PM Cobalt	black	through hole	DIN/ANSI	axial coolant	C		TiCN coated	2BX	162
4392	UNC	Cobalt	green	blind hole	DIN/ANSI		C	40°	TiN coated	2B	80
4393	UNF	Cobalt	green	blind hole	DIN/ANSI		C	40°	TiN coated	2B	80
4394	UNC	PM Cobalt	red	through hole	DIN/ANSI	axial coolant	C		TiCN coated	2BX	104
4394	UNC	PM Cobalt	white	through hole	DIN/ANSI	axial coolant	C		TiCN coated	2BX	139
4394	UNC	PM Cobalt	black	through hole	DIN/ANSI	axial coolant	C		TiCN coated	2BX	162

TECHNICAL QUESTIONNAIRE

INQUIRY ORDER SAMPLE

For the Application of Taps

Reference No. _____

ENDUSER

Company Name _____

Street Address _____

City _____ State/Prov _____

Zip/Postal Code _____ Country _____

Contact Person _____

Title _____

Tel _____ Fax _____

Email _____

GUHRING Territory Manager _____

Tel _____ Fax _____

DISTRIBUTOR

Company Name _____

Street Address _____

City _____ State/Prov _____

Zip/Postal Code _____ Country _____

Contact Person _____

Title _____

Tel _____ Fax _____

Email _____

WORKPIECE

Material Name / Description: _____

ANSI Material No.: _____ Hardness (If Aluminum, please list Silicon content) _____

German Material No. *Internal use only*: _____ Thread Depth _____

Predrilled Hole Diameter: _____

Hole Type Blind Through

TOOL

Blank Type: DIN ANSI Special

Tool Type: Tap Form Tap Lubricant Through

Tool Material: HSS-E PM HSS-E Carbide

Coating: Bright Oxided Nitrided TiN TiCN TiAlN FIREX® AlTiN MolyGlide™ Other

Size(s): _____

Chamfer Type (No. of threads included): _____

Notes: _____

MACHINE

Machine Type / Name: _____

Spindle Position: Horizontal Vertical Oblique

TOOLHOLDER

Holder Type: Tapping Chuck Collet (Rigid) Tapping Attachment Tension / Compression Tapping Chuck

LUBRICANT

Lubricant Type: Water Soluble Cutting Oil Minimal Lubricant Dry

FEED

Feed Type: Pneumatic Hydraulic Manual Mechanical

QUANTITIES

Quantities To Quote: _____

Email Guhring Specials
GuhringSpecials@guhring.com

GÜHROSynC

UP TO 30% BETTER PERFORMANCE AT A POWER PRICE

Allows for 0.3 mm of compensation for up to 75% reduction in axial forces

Offers internal, peripheral or MQL lubrication

Extreme concentricity and application speed

First tapping chuck to offer combination of steel and polymer components for independent axial and torsional force dampening

Quick and simple handling, slim design

Maximum tool life and thread accuracy



The new **GÜHROSynC** tapping chuck

Synchro and hydraulic clamping technology intelligently combined

by **GUHRING**

GUHRING

DRILLING

TAPPING/THREAD-
MILLING/FLUTELESS
TAPPING

MILLING

REAMING

PCD/PCBN



SPECIAL TOOLING
SOLUTIONS

COUNTERSINKING/
DE-BURRING

MODULAR TOOLING
SYSTEMS

TOOL RECONDITIONING SERVICE



Guhring, Inc. Main Office

1445 Commerce Avenue
Brookfield, WI 53045
Tel (262) 784-6730 (800) 776-6170
Fax (262) 784-9096

East Coast Reconditioning Facility

121 W Dudley Town Rd.
Bloomfield, CT 06002

**West Coast Distribution Center and
Reconditioning Facility**

15581 Computer Ln
Huntington Beach, CA 92649

**Michigan Manufacturing and
Reconditioning Facility**

24875 Trans-X Road
Novi, MI 48375

Guhring Corp. (Canada)

20 Steckle Place, Unit #14
Kitchener, ON N2E 2C3
Tel (519) 748-9664 (800) 463-5555
Fax (519) 748-2954

Item #: 400001035 11/18

HIGH PERFORMANCE TAPS

GUHRING